

ADVENT HORIZON

Core Rulebook





ADVENT HORIZON
Science Fiction Role Playing Game

CORE RULEBOOK

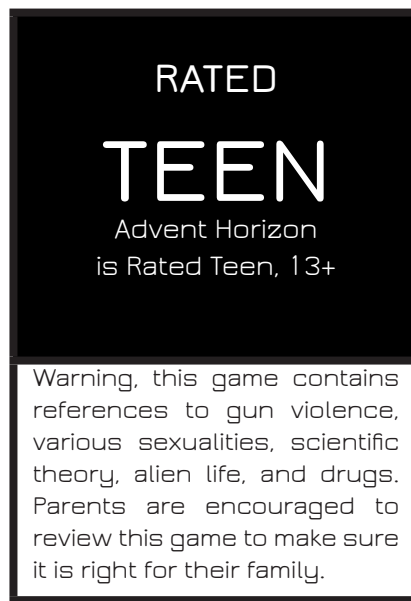

Credits

Written and Designed by Ashram Kain
Additional Design by James Nixon and Brandon Miller
Additional writing by Lee Hadan
Cover and Interior illustrations by Ameilee Sullivan
Additional illustrations by Ashram Kain
Layout and Graphic Design by Ashram Kain
Vectors provided curtesy of www.Vecteezy.com

Copyright 2019 Ashram Kain and OgreTree Publishing

First Printing April 2019

We are cannot be held responsible for any damage done to the spacetime continuum with this product,
nor is it our fault that the GM TPK'd the party.

Contents

PRELUDE	4		
SECTION 01 GETTING STARTED	5		
Playing the Game	5		
Imperial and Metric Measurements	7		
Dice and Rolls	7		
Rolling Dice	8		
Building Character	9		
Advancement	12		
SECTION 02 ABILITY SCORES	13		
Generating Ability Scores	13		
Ability Scores and Modifiers	14		
Ability Score Descriptions	15		
SECTION 03 SPECIES	17		
Ba'alur	19		
Colonial	21		
Ephari	23		
Empyrean	25		
Ixaxian	27		
Seyvul	29		
Thothid	31		
Urroru	33		
Xhu Akreen	35		
SECTION 04 CLASSES	37		
Agent	39		
Combat Specialist	42		
Diplomat	45		
Explorer	48		
Insurgent	50		
Marshal	52		
Science Specialist	55		
Spacer	57		
Spiritualist	60		
Tactician	63		
Technophile	66		
Multiclassing	69		
SECTION 05 BACKGROUNDS	71		
Character Details	71		
Building a background	72		
Axis Alignment	87		
Inspiration	88		
SECTION 06 PROFICIENCIES	89		
Proficiencies and Specialties	89		
Alien Technology	90		
Passive Checks	90		
Skills	91		
Tools	105		
Traits	108		
SECTION 07 EQUIPMENT			111
Credit			111
Reputation			112
Equipment			114
Armor			114
Weapons			117
Exploration Equipment			124
Computers			129
Vehicles			132
Services and Permits			134
Contacts and Connections			137
SECTION 08 COMBAT AND ACTION			141
The Order of Combat			141
Actions in Combat			144
Damage and Healing			148
Vehicle Combat			151
Environmental Variables			154
SECTION 09 EXPLORATION			155
Time			155
Movement			156
The Environment			158
Inanimate Objects			161
Rest and Recuperation			162
Downtime			162
SECTION 10 SPACESHIPS			165
Space Technology			165
Spaceships			167
SECTION 11 AUGMENTATION			179
Cybernetics			179
Psionics			184
Designer Drugs			187
SECTION 12 THE ARC			189
History of the Arc			189
Powers of the Arc			194
SECTION 13 THE GAME MASTER			203
Game Mastery			203
Forging the Galaxy			205
Adventuring			208
Encounters			212
Non-Player Characters			213
APPENDIX A: HAZARDS			220
Conditions			220
Radiation			221
Antipathy			222
APPENDIX B: HOSTILES			226
APPENDIX C: CONVERSION			231
Entering Dungeons and Dragons			231
Entering Advent Horizon			233
LEGAL INFORMATION			236
CHARACTER SHEETS			

PRELUDE

Welcome to Advent Horizon, a science fiction role playing game that is built upon the foundations of the Open Gaming License. This title is based on the OGL5.1 and includes a host of new rules to take your game to the stars.

I hope that Advent Horizon can be a tool to harness and direct your imagination into a fun and constructive social outlet. The nature of role-playing games is one of community, camaraderie, and adventure. These elements are exemplified in Advent Horizon, the focus of all characters and settings should be one of adventure and teamwork, as well as personal exploration, problem solving, and having a good time!

Role playing games have really come in to their own in the last few years, and though a lot of the social stigma associated with them has declined, so has an important element of what role play games offer and teach players; think for yourself, question assumptions, keep an open mind.

A GALAXY OF ADVENTURE

While this game contains all the rules you need to create a science fiction universe of your own, the specific historical accounts related to the races, places, and civilizations of the galaxy are components a grand space opera taking place at the dusk of the third millennium in a corner of the galaxy colloquially known as the Arc. With the Arc as a setting you can jump straight into making characters and adventuring. You are also able to imagine your own unique setting, based on the advanced rules presented herein.

The universe of the Advent Horizon closely follows our understanding of natural laws, what's called "hard" science fiction. There are exceptions, however. The Horizon Drive, while based on the principles of the Alcubierre drive and expanded upon by Extended Heim Theory to allow substantial gravity-like fields through non-standard topological mutation of spacetime, is pure fiction. No alien life is known to exist, and so the biology of these things is based on terrestrial analogues. Finally, this book contains references to psychic and psionic phenomena. This is fantastical in the extreme and there is absolutely no scientific basis for any of the psionic concepts presented as plausible in this book. While the rules and lore of Advent Horizon aim to be both real, and realistic, liberties must be taken in the name of fun and imagination.

It's up to the up to you to include as much, or as little, of the epoch of Advent Horizon as you choose. Because that's what games such as Advent Horizon, and Dungeons and Dragons, are about: choice.

Ashram Kain
March, 2019

SECTION 01 GETTING STARTED

PLAYING THE GAME

Advent Horizon is an operatic science fiction role-playing game compatible with Dungeons & Dragons 5th Edition through the Open Gaming License and the SRD5. A Role-Playing Game is two parts improve theater, and one-part mechanics for determining out-come. The first table top role-playing games evolved from board games. The newest generation is strongly influence by video-games and interactive media (and vice-versa).

In Advent Horizon Players will take on the role of imaginary characters they themselves have crafted; one person will take on the mantel and responsibility of the Game Master - the story teller, director, and arbiter of the rules. With the power of the imagination the Game Master sets the stage and adventure for the players who, as their characters, must face the challenges that await them in the story of the Game Master is crafting.

How to Play

Set the Cast

As a player you will take on the persona of a character of your own devising. You and your fellow players each with their own characters form the cast. Using your imagination take on the role of this persona you have crafted, overcome challenges, defeat enemies, and be a part of an amazing story. This is the heart of a role-playing game.

Your character is constructed from a series of numbers and characteristics - Ability Scores, Species, Class, and proficiencies to name a few. As you craft your character you will develop a history, personality and outlook unique to them, and how they see the galaxy.

Chaiden, Marduke, and Isbeth could not be more different - Chaiden: the merciless assassin and former weapon of the Zaibatsu. While he is free of the mind control that turned him in to the perfect weapon, he can never be free of the memories of the things he has done. Marduke: cybernetic eco-terrorist and soldier in the war to save the planet from the Zaibatsu's Nano-technology. He was once a loving father, husband, and scientist, but they took that when they tried to take his life. Isbeth: the daughter of the genius mind that gave rise to nano-technology, she fights now to protect the world from her father's creations.

Set the Stage

You will imagine the Scene that the Game Master has described, and your character in it. You will see and act upon this scene through your character, in the guise of your character's persona. The Game Master will tell you where you are, what you see, and what the situation is like. It will be your job to act upon this information in character, thus, as a Player Character.

The Game Master says: You arrive at the reactor a little after sundown. The wind is like a thousand ice needles cutting through your cloths. You stand at the cliff top overlooking the industrial complex below - the blue-green glow of the nano-tech lights drifts up through the snow. The reactor is like an enormous pillar rising from a crater in the ground, the ring of the crater is a huge wall. Metal grated walkways snake out from the reactor pillar. Below you can see the security patrol walking the causeways and walls. There are maybe ten guards you can see - all armed. As you look down through the snow storm you see the movement of an automated security drone as well. A big one. What do you do?

Action!

The hardest part is deciding what YOU the player character do. Do you leap down from the cliff and attack the guards head on? Or do you wait till you have an opportunity to attack from the shadows? If you're really clever you might be able to get in unnoticed and disable the security system. The best thing about an RPG is that the character you are playing can do almost anything. There are no limits on what choices or actions you can take, although there are limits to what you can know and do based on the abilities of the character you are playing.

Marduke is neither patient nor subtle; with a gruff "I'll make a distraction" The cyborg leaps from the cliff and on to the wall a few dozen meters below. Meanwhile Chaiden has already begun scaling down the cliff to make best use of the guards' surprise. Isbeth is shocked and was completely unprepared for Marduke's brash attack, so she waits to see what unfolds before she gets caught in the middle.

As you choose what actions you take remember, that you are experiencing the events through your character's eyes. Choose actions consistent with your character's outlook, knowledge, and personality.

What you need to Play

Role Playing games require at least two and as many as ten (or more) players. One player is the Game Master - the story teller and director. The other players are Player Characters, who experience and shape the story through their character personas. All of this requires a great deal of Imagination - the ability to visualize the events that the Game Master and other players describe.

Besides your Imagination - you will need a pencil and paper, and a few polyhedral dice 4, 6, 8, 12, and 20-sided dice as well. Experienced gamers tend to have huge dice collections and keep them in weird bags.

Players will record their characters on a character record sheet, a blank copy of which is provided at the end of this book, and Game Masters may wish to have "cheat sheets" available that include quick reference for many of the rules used in action.

Paper and pencil too analogue for you? We live in an era of massive computing power, a world where virtually everyone has access to a mobile computer. So why not use those tools for playing the game? The electronic version of this text includes an editable version of the character record sheet, which can also be found online on our web site.



Using the Text

As a player, you do not need to memorize the text. As a matter of fact, you don't have to learn everything there is to know about this game to enjoy it and take part in an epic space adventure. Use the books as a reference, a lot of this is fun to read and think about the heroes, villains, and the mysteries; and where your character fits in to that. Admittedly some parts are bone dry - and that is solely the fault of the author.

This book is broken down into a number of sections regarding rules for characters, creatures, and adventures. Throughout these pages you will find bits of information that hint at a unique galaxy with its own history, legends, and players, the Advent Horizon's primary campaign setting. But this is not the only possible future of humanity, and so the rules are written to account in a large degree for any number of settings that the Game Master can imagine set in the near or far future, amid the black ocean of stars.

IMPERIAL AND METRIC MEASUREMENTS

Throughout Advent Horizon you will notice metric measurements are used for mass and distance. Many Americans are not familiar with the metric system, as such there is a conversion chart below to help you understand the measurements used throughout this book.

Distance

Imperial		Metric
1 Inch (in, ")	--	2.54 cm
1 Foot (ft,')	12 Inches	0.3048 m
1 Yard (yrd)	3 feet or 36 Inches	0.9144 m
1 Mile (mi)	1760 yrd or 5280 ft	1.6093 km
1 Nautical Mile (nmi)	2025.4 yrd, 1.151 mi	1.853 km
1 Astronomical Unit (AU)	92,955,807.273 mi	149,597,870.7 km
1 Light Year (LY)	5.8786×10^{12} mi	9.4607×10^{12} km

Metric		Imperial
1 Millimeter (mm)	--	0.03937 in
1 Centimeter (cm)	10 mm	0.3937 in
1 Meter (m)	100 cm	1.0936 yd
1 Kilometer (km)	1000 m	0.6214 mile
1 Nautical Mile (nmi)	1.835 km	1.151 mi
1 Astronomical Unit (AU)	149,597,870.7 km	92,955,807.273 mi
1 Parsec (pc)	30.857×10^{12} km	19.174×10^{12} mi

Mass

Imperial		Metric
1 Ounce (oz)	--	28.35 grams
1 Pound (lb.)	16 oz	0.454 kg
1 Stone	14 lb.	6.35 kg
1 Hundredweight	112 lb.	50.8 kg
1 Short Ton (ton)	2000 lb.	907 kg

Metric		Imperial
1 Milligram (mg)	--	--
1 Gram (g)	1000 mg	0.0353 oz
1 Kilogram (kg)	1000 g	2.2046 lb.
1 Tonne (t)	1000 kg	1.1 ton

DICE AND ROLLS

In Advent Horizon, you will use d20 – twenty sides dice – to decide the outcome of actions and reactions, and all the other dice to determine the effect of those actions. These are called Action Rolls and Effect Rolls. Whenever a character is attempting to do something, the player or Game Master must make an Action roll. Whenever a character has done something, and the exact outcome is in question or varies, then make an Effect roll to determine the specifics of the outcome.

Action rolls are made whenever a character tries to take some action that is either difficult or contested, it is the roll used when you attack, when you save against an attack, or when you use a specialty. Attack rolls, skill checks, and saving throws are the three main kinds of Action rolls.

An Action roll is usually 1d20, and you might add your Ability Score modifier or Proficiency Bonus. Situational modifiers may add additional bonuses or additional dice. The goal of the Action roll is to meet or exceed a target number; the Difficulty Class.

In Action

Your Gamemaster says: "Alright Marduke, you jumped off the cliff. Chaiden is on his way down. Isbeth, since you still have the high ground, make a Perception check for me". Perception is a Skill Isbeth is proficient in.

Isbeth's player rolls her D20: "13", she reports. "but wait, I have a +2 proficiency bonus on Perception, and my Wisdom Modifier is +2 too, which makes it 17!"

Your Gamemaster says: "Not bad! You spot a second wave of enemies waiting to ambush Marduke and Chaiden as soon as they turn their backs."

Typical Difficulty Classes

Task Difficulty	DC
Very easy	5
Easy	10
Medium	15
Hard	20
Very hard	25
Nearly impossible	30

Action Rolls are made whenever there is a meaningful chance of failure, or the player is trying to accomplish something far outside the bounds of day to day tasks. Any character is assumed capable of performing a skill with no chance of failure, under normal, uncontested, ordinary situations.

Effect rolls include damage done by an attack in combat, variable outcomes of the application of Specialties or Feats, as well as random situational modifiers. A weapon's damage, the duration of a jury-rigging skill, or other numerical effects are example of Effect rolls. This are usually other dice besides d20, such as 2d8 or 3d6. Like action rolls, Effect rolls will often include attribute modifiers or other situational modifiers.



ROLLING DICE

Action Rolls are made whenever there is a meaningful chance of failure, or the player is trying to accomplish something far outside the bounds of day to day tasks. Any character is assumed capable of performing a skill with no chance of failure, under normal, uncontested, ordinary situations.

Characters who can take the time to do it right should not roll. For instance, a character with a programming ability can write programs given enough time; they needn't roll for this unless they are attempting to solve a new complex problem, or fix an unusual bug.

Proficiency Bonus

Characters have a proficiency bonus determined by level. Monsters also have this bonus, which is incorporated in their stat blocks. When you have Proficiency, you will add this bonus to specialty checks such as skills and attack rolls, and saving throws.

Your proficiency bonus can't be added to a single die roll or other number more than once. For example, if two different rules say you can add your proficiency bonus to a Wisdom saving throw, you nevertheless add the bonus only once when you make the save.

Occasionally, your proficiency bonus might be multiplied or divided (doubled or halved, for example) before you apply it. If a circumstance suggests that your proficiency bonus applies more than once to the same roll, you still add it only once and multiply or divide it only once.

By the same token, if a feature or effect allows you to multiply your proficiency bonus when making an ability check that wouldn't normally benefit from your proficiency bonus, you still don't add the bonus to the check. For that check your proficiency bonus is 0, given the fact that multiplying 0 by any number is still 0.

In general, you don't multiply your proficiency bonus for attack rolls or saving throws. If a feature or effect allows you to do so, these same rules apply.

Situational Modifiers

An ability or circumstance might apply a situational modification to an action roll, most commonly in the form of Advantage or Disadvantage. When this happens, you roll a second d20 when you make the action roll. Use the higher of the two rolls if you have advantage and use the lower roll if you have disadvantage. For example, if you have disadvantage and roll a 17 and a 5, you use the 5. If you instead have advantage and roll those numbers, you use the 17.

If multiple situations affect a roll and each one grants advantage or imposes disadvantage on it, you don't roll more than one additional d20. If two favorable situations grant advantage, for example, you still roll only one additional d20. If circumstances cause a roll to have both advantage and disadvantage, you are considered to have neither of them, and you roll one d20. This is true even if multiple circumstances impose disadvantage and only one grants advantage or vice versa. In such a situation, you have neither advantage nor disadvantage.

When you have advantage or disadvantage and something in the game allows you to reroll the d20, you can reroll only one of the dice. You choose which one.

Contests

Sometimes one character's efforts are directly opposed to another's. This can occur when both of them are trying to do the same thing and only one can succeed, such as attempting to catch a detonator that has been tossed in the air. This situation also applies when one of them is trying to prevent the other one from accomplishing a goal— for example, when an enemy tries to force open a door that an adventurer is holding closed. In situations like these, the outcome is determined by a special method of ability check, called a contest.

Both participants in a contest make ability checks appropriate to their efforts. They apply all appropriate bonuses and penalties, but instead of comparing the total to a DC, they compare the totals of their two checks. The participant with the higher check total wins the contest. That character either succeeds at the action or prevents the other one from succeeding.

If the contest results in a tie, the situation remains the same as it was before the contest. Thus, one contestant might win the contest by default. If two characters tie in a contest to grasp the detonator, neither character grabs it. In a contest between an enemy trying to breach a door and a spacer trying to keep the door closed, a tie means that the door remains shut.

BUILDING CHARACTER

Advent Horizon characters are familiar if you have played other OGL games - you will roll ability scores, select a Species, select a Class, and then determine features like feats and skills. You will dictate the appearance, personality, and behavior of your character as you play. In Advent Horizon you take on the role of brave men and women at the frontier of space, where skills and knowledge are paramount in the face of adversity.

Before rolling your ability scores and selecting a species and class, you should consider the type of character you would like to play. Are you a roguish smuggler or a stern imperial commando? Do you want to be on the front lines are you going to be the one repairing the party's equipment?

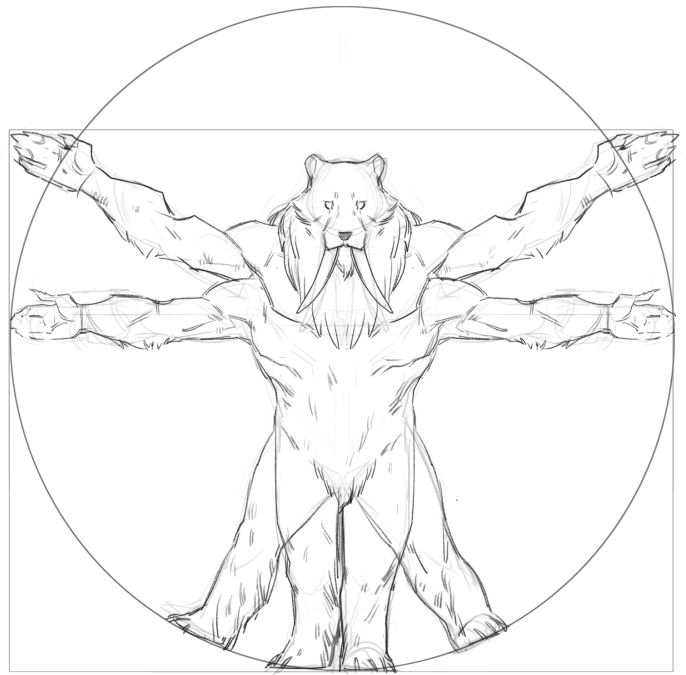

Unlike fantasy games, characters of Advent Horizon are not as defined by their Class; Skills and Specialties play a crucial role in building and defining what you can do as your character. Through Skills you will gain skill proficiencies and feats to customize your character. This is different from similar OGL games, where skills are little more than ability checks, open to every character. What you know defines what you can do in a science fiction game.

First, roll Ability Scores

All characters, regardless of how alien, possess the same six ability scores: Strength, Dexterity, Constitution, Intelligence, Wisdom, and Charisma. Each ability score has a number that will define your character's fundamental capability. Characters with exceptional scores receives a bonus to specialties and action related to that ability score, whereas characters with extra ordinarily low ability scores will suffer penalties. Ability scores are discussed in depth in Section 2.

Ability scores are generated by rolling two six-sided dice and adding 6. Once you have generated your initial ability scores, record them on you character data sheet. Remember, your scores will increase as you continue through building your character.

Second, select a Species

Every character is one of nine sentient species that inhabit what is colloquially known as the galactic community. Some of these species have sub-species, which each have slightly different traits. Your character's Species is critical in understanding their cultural perspective, how they see the galaxy, as well as unique genetic traits they may possess.

Your selection of species could help inform you class selection to a degree, Ba'alur are excellent Insurgents, and Seyvul make superb Agents - but in Advent Horizon what you do and what you know defines you more than what you are. That said, many of your species' traits will augment class abilities and specialties.

Skills

Your Species will provide you with a suite of Skills, including special skill specialties and feats you will be able to select. You do not automatically have proficiency in these specialties, unless stated otherwise, but are free to allocate specialty slots to them later on, as well as use them Untrained.

Once you have chosen your species, be sure to record it on your character data sheet, as well as your movement speed and traits.

Third, select a Class

It takes special skill and experience to become one of the few elites that can explore the space ways with impunity. A character's class is more than a passion, it represents specialized training and natural ability that is extraordinary.

Each class has a number of features, some of which you may give you a selection, others that are common to all members of the class. These abilities set you apart from other classes as well as from your average galactic citizen.

Your class will provide several Skill proficiencies. Each Skill has several specialties you may select once you have proficiency in the Skill. Specialties are specific skills such as weapon proficiency, engineering, or Feats, such as combat maneuvers or even psionic potential. You could think as each Skill as a skill tree that opens up once you are proficient in the basics.

Class Levels

Most adventurers begin at 1st level. As you embark on missions, make discoveries, and defeat enemies you will gain experience points, or XP. As you accumulate XP you will increase your level. Each level you achieve will increase your

hit points, unlock new abilities from your class, increases your proficiency bonus, and you might gain specialties at some levels.

Hit Points

Hit points indicate how much damage your character can sustain before succumbing to their wounds. Each level you will roll a Hit Dice, as determined by your class, and add it to your hit point total. You get to add your constitution modifier to this roll, and some traits, features, or feats may increase this as well.

Proficiency Bonus

One of the most important values to remember is your proficiency bonus. When you try to use a skill with which you are proficient, you add your proficiency bonus to that action roll. Whether it is firing a blaster or hacking a mainframe.

You also add your proficiency bonus to any saving throws you are proficient in, and well as to the DC of any saving throws made against your more exotic attacks and actions such as combat feats, special weapons, and psionic abilities.

Unless specific rules state otherwise, you can only add your proficiency bonus to an action roll once. However, you may gain additional bonuses to the roll (or penalties) that impact this.

Reputation Modifier

As characters gain levels, their accomplishments and deeds proceed them, and their legend in the galaxy grows. This reflects as a Reputation modifier that increases as you gain levels.

You will use your reputation modifier on Contacts and Connections checks to gain useful information, equipment, and favors. Like credit, reputation is a measure of your character's resources, specifically interpersonal resources.

You will use your Reputation modifier primarily on reputation checks to leverage contacts and connections. Under special circumstances your GM may allow you to add it to some specialties.

Fourth, build your backgrounds

One of the defining characteristics of your character is their Backgrounds: Education, Profession, and Event. These building blocks not only help you flesh out your character's personality, story, and history, they provide valuable character information. This section also includes information on your age, physical characteristics, and alignment axis.

Your education will help describe your character's personality and training. Are you driven by a lust for knowledge and insatiable curiosity? Or is your character at home being told their place in the galaxy and following orders? Each educational background includes a selection that are most closely associated with it, but you are free to choose any you like.

Profession is rather self-explanatory – what did your character do for money before taking up adventure in the expanse of space? Your career will provide some starting credit and reputation, and perhaps some proficiencies.

Finally, the Event is the specific catalyst that lead you to the outside of normal, and into a life of adventure. This is what both haunts and binds your character, and each even will have a selection of Flaws in your personality to make your character more human and believable. There are multiples options for each event, but you are free to make your own.

Fifth, Select Proficiencies

You gain a selection of proficiencies and open proficiency slots from your species, class, and background. Your Intelligence modifier give you a bonus to the number of proficiency slots you have.

Later, you will spend proficiency slots to develop proficiency on a core skill such as athletics, sciences, and simple weapons, or to develop a core skill further by selecting one of the skills and feats under that core proficiency, known as specialties. A Specialty Proficiency is an advanced ability derived from that core skill, such as advanced weapon proficiencies, or scientific expertise.

Each slot will grant you proficiency in one core skill, specialty skill or specialty feat. These will combine to paint a picture of your character's capabilities and powers. In Advent Horizon, skills are extremely important. Once you have allocated your proficiency slots, recording these on your character data sheet.

Sixth, Contacts and Equipment

Rather than count every credit you have, Advent Horizon uses a Credit modifier that reflects your character's purchasing power—a composite of income, credit rating, and savings. A character's Credit modifier is exactly like an ability score modifier, and is added when you roll a Credit check, which is used to purchase your equipment and services.

You also have a Reputation modifier, this is your ability to leverage connections and influence to gain favors and contacts. As with equipment you may make Reputation rolls during character creation to gain a number of helpful contacts before you begin play.

Seventh, Finishing touches

Finally, bring this all together. Calculate your final ability scores, select an Alignment Axis for your character to help guide their personal outlook if you haven't already and use the optional character detail information to round out your character's name, age, physical appearance, and other characteristics.



ADVANCEMENT

Throughout your career in the galaxy, you will gain experience, credit, and reputation. Experience in particular is count in Experience Points, or Exp for short. As you accumulate exp you will inevitably reach new plateaus; Levels of Experience.

Each level of experience will bring with it new gains; your hit point maximum will increase, your reputation will increase, your proficiency bonus may increase, you may gain new class features, and you may gain new slots for specialties.

As you gain levels in most classes you receive ability score bonuses, which may increase your ability score modifiers. When your ability score modifier changes, so to do its secondary effects - if you increase your intelligence score from 15 to 16, and your modifier increases from +1 to +2 and you gain an additional specialty slot. Likewise, if you increase you Constitution score from 13 to 14, you would gain +1 hit point per level you have already attained because your constitution modifier has increased from +0 to +1.

As you advance you have many options of how to customize your character, you might continue in your chosen class, or choose to multiclass. You might develop unusual feats or focus on learning skills. The choice is yours. The progression table below describes the experience you need to gain levels and what all character, regardless of class levels, achieve as the grow.

Progression Table

Level	Exp. Points	Prof. Bonus	Prof. Slots	Rep.
1	0	+2		+1
2	300	+2		+1
3	900	+2	+1	+1
4	2,700	+2		+1
5	6,500	+3		+1
6	14,000	+3	+1	+1
7	23,000	+3		+1
8	34,000	+3		+1
9	48,000	+4	+1	+1
10	64,000	+4		+1
11	85,000	+4		+1
12	100,000	+4	+1	+1
13	120,000	+5		+1
14	140,000	+5		+1
15	165,000	+5	+1	+1
16	195,000	+5		+1
17	225,000	+6		+1
18	265,000	+6	+1	+1
19	305,000	+6		+1
20	355,000	+6		+1

Inspiration

The Game Master has the option to reward you for role-playing your character faithfully to her characteristics, such as personality traits, ideas, and flaws, or for taking inspiring and dramatic action in game. At the GM's discretion you may be awarded a point of Inspiration to use or give to another player.

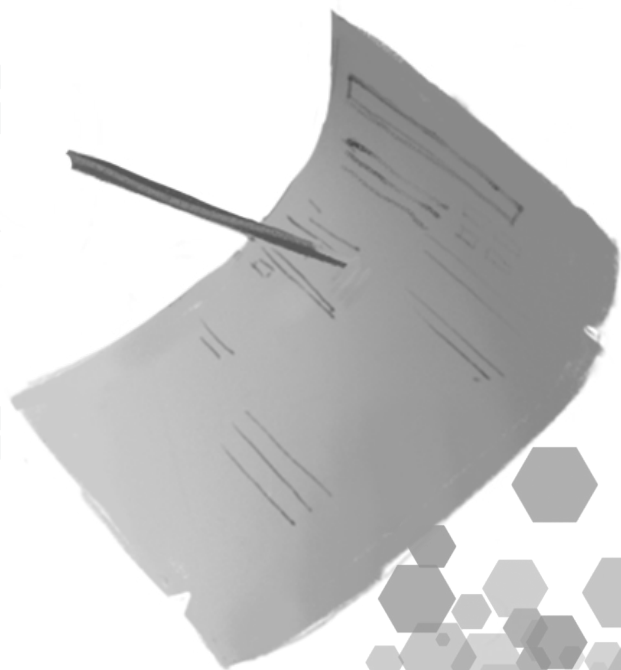

SECTION 02 ABILITY SCORES

Even the most alien creatures have much in common. Six abilities provide a quick description of every creature's physical and mental characteristics:

- Strength, measuring physical power
- Dexterity, measuring agility
- Constitution, measuring endurance
- Intelligence, measuring reasoning and memory
- Wisdom, measuring perception and insight
- Charisma, measuring force of personality

Every character, and in fact every creature, can be described with these characteristics, called Ability Scores. These qualities - a creature's assets as well as weaknesses - are rated from 1 to 30, with most character ability scores falling between 3 and 20.

The three main action rolls of the game - the specialty check, the saving throw, and the attack roll - are all modified by one of the six ability scores.

GENERATING ABILITY SCORES

There are several options for ability scores. The default option is to randomly generate each ability score by rolling 2d6+6 six times and place them in the abilities as you choose. Now take these six numbers and write each beside one of your character's six abilities to assign scores to Strength, Dexterity, Constitution, Intelligence, Wisdom, and Charisma. Later be sure to make any changes to your ability scores because of your choice species. However, this is not the only option for generating ability scores.

Static Ability Scores

If your GM would like to save time or does not like the idea of randomly determining ability scores, you can use the following scores instead: 15, 14, 13, 13, 12, 11.

After assigning your ability scores, determine your ability modifiers using the ability scores and Modifiers table. To determine an ability modifier without consulting the table, subtract 10 from the ability score and then divide the result by 2 (round down). Write the modifier next to each of your scores.

Ability Point System

While randomly generated ability scores are both fun and traditional, you Game Master may opt to use more controlled character creation systems. The optional Ability point system allows players to generate balanced scores by buying them with points. The variant described here allows you to build a character with a set of ability scores you choose individually.

Using this method, you have 42 points to spend on your ability scores. The cost of each score is shown on the Ability Score Point Cost table below. For example, a score of 14 costs 7 points. Using this method, 17 is the highest ability score you can end up with, before applying bonuses from your species and gaining levels. You can't have a score lower than 6.

This method of determining ability scores enables you to create a set of numbers that are minimums and maximums at the cost of extreme specialization.

ABILITY SCORES

Ability Score Point Cost

Ability Score	Point Cost
6	0
7	1
8	2
9	3
10	4
11	5
12	6
13	7
14	8
15	9
16	10
17	11

ABILITY SCORES AND MODIFIERS

Each of a creature's abilities has a score, a number that defines the magnitude of that ability. An ability score is not just a measure of innate capabilities, but also encompasses a creature's training and competence in activities related to that ability.

A score of 10 or 11 is the normal human average, but adventurers and many monsters are a cut above average in most abilities. A score of 18 is the highest that a person usually reaches. Adventurers can have scores as high as 20, and monsters and divine beings can have scores as high as 30.

Each ability also has a modifier, derived from the score and ranging from -5 (for an ability score of 1) to +10 (for a score of 30). The Ability Scores and Modifiers table notes the ability modifiers for the range of possible ability scores, from 1 to 30.

Ability Scores Modifiers

Score	Modifier
1	-5
2-3	-4
4-5	-3
6-7	-2
8-9	-1
10-11	+0
12-13	+1
14-15	+2
16-17	+3
18-19	+4
20-21	+5
22-23	+6
24-25	+7
26-27	+8
28-29	+9
30	+10

You can determine an ability modifier without consulting the table, by subtracting 10 from the ability score and then dividing the total by 2 (round down). Because ability modifiers affect almost every attack roll, ability check, and saving throw, ability modifiers come up in play more often than their associated scores.



ABILITY SCORE DESCRIPTIONS

Strength

As an ability score, Strength measures bodily power, athletic training, and the extent to which you can exert raw physical Force. Strength skills include armor proficiency, climbing, martial arts, and melee weapons.

Strength Checks

A Strength check can model any attempt to lift, push, pull, or break something, to force your body through a space, or to otherwise apply brute force to a situation. The GM might also call for a Strength check when you try to accomplish tasks like the following:

- Force open a stuck, locked, or barred door
- Break free of bonds

Attack Rolls and Damage

You add your Strength modifier to your attack roll and your damage roll when attacking with a melee weapon such as a tonfa or sword, or with martial arts. Strength is generally vital in hand to hand combat, as well as some ranged attacks such as how far you can throw a grenade.

Lifting, Carrying, and Encumbrance

Your Strength score determines the amount of weight you can bear. The following terms define what you can lift or carry.

Carrying Capacity. Your carrying capacity is your Strength score multiplied by 7kg. Most characters can carry 20 or more kilograms of weight with no worries. If you carry weight in excess of 2 times your Strength score (in kg), you are encumbered, which means your speed drops by 3 meters.

If you carry weight in excess of 5 times your Strength score, up to your maximum carrying capacity, you are instead heavily encumbered, which means your speed drops by 6 meters and you have disadvantage on ability checks, attack rolls, and saving throws that use Strength or Dexterity.

Push, Drag, or Lift. You can push, drag, or lift a weight in kilograms up to twice your carrying capacity (or 15 times your Strength score). While pushing or dragging weight in excess of your carrying capacity, your speed drops to 2 meters.

Size and Strength. Larger creatures can bear more weight, whereas Tiny creatures can carry less. For each size category above Medium, double the creature's carrying capacity and

the amount it can push, drag, or lift. For a Tiny creature, halve these weights.

Dexterity

Your Dexterity is a measurement of hand-eye coordination, kinesthetic intelligence, reflexes, and balance. Specialties under Dexterity include skills such as stealth, finesse-based weapon proficiency, and most ranged weapon proficiency.

Dexterity Checks

A Dexterity check can model any attempt to move nimbly, quickly, or quietly, or to keep from falling on tricky footing. Beyond specialties, the GM might call for a Dexterity check when you try to accomplish tasks like the following:

- Balance on a ledge or beam but keep moving at full speed
- Catch an item dropped by another character

Attack Rolls and Damage

You add your Dexterity modifier to your attack roll and your damage roll when attacking with a ranged weapon, such as an energy pistol or mass driver rifle. You can also add your Dexterity modifier to your attack roll and your damage roll when attacking with a melee weapon that has the finesse property, such as a rapier or combat knife.

Armor Class

Depending on the armor you wear, you might add some or all of your Dexterity modifier to your Armor Class.

Initiative

At the beginning of every combat, you roll initiative by making a Dexterity check. Initiative determines the order of creatures' turns in combat.

Constitution

Constitution measures general health, stamina, and will to live. Specialties under constitution are all related to movement, endurance and stamina.

Constitution Checks

A Constitution check might be called for when you attempt to push beyond normal physical limits. The GM might call for a Constitution check when you try to accomplish tasks like the following:

- Hold your breath
- March or labor for hours without rest
- Go without sleep

Hit Points

Your Constitution modifier contributes to your hit points. Typically, you add your Constitution modifier to each Hit Die you roll for your hit points. If your Constitution modifier changes, your hit point maximum changes as well, as though you had the new modifier from 1st level. For example, if you raise your Constitution score with a bonus from your class at 4th level and your Constitution modifier increases from +1 to +2, you adjust your hit point maximum as though the modifier had always been +2. So you add 3 hit points for your first three levels, and then roll your hit points for 4th level using your new modifier. Or if you're 7th level and some effect were to lower your Constitution score so as to reduce your Constitution modifier by 1, your hit point maximum is reduced by 7.

Intelligence

Your character's Intelligence measures mental acuity, accuracy of recall, and the ability to reason. Almost all technical and academic specialties fall under Intelligence.

Intelligence Checks

An Intelligence check comes into play when you need to draw on logic, education, memory, or deductive reasoning. The GM might call for an Intelligence check when you try to accomplish tasks like the following:

- Communicate with a creature without using words
- Memorize a long passage, set of numbers, or password

Specialties

Because Intelligence reflects your ability to learn and remember, your Intelligence Modifier also impacts the number of Specialty Slots you begin with at first level. At 1st level you may add your intelligence modifier to known specialties. These bonus specialties can be under any Skill. If your Intelligence modifier changes, you gain or lose specialties accordingly. So, if you increase your Intelligence at level 8 that increases your modifier from +1 to +2, you would gain an additional Specialty. Likewise, if at 12th level some effect causes your intelligence to decrease, and your modifier were to change from +4 to +3 you would lose one specialty of your choice.

Wisdom

A character's Wisdom speaks to their mindfulness, foresight, philosophical perceptiveness and intuition. Specialties under wisdom include Perception, business management, resolve and creative arts.

Wisdom Checks

A Wisdom check might reflect an effort to read body language, understand someone's feelings, or notice things about the environment. Wisdom checks that the GM may call for can include:

- Intuiting the best course of action under pressure
- Understanding the motivations of an enemy

Credit

You add your Wisdom modifier to your Credit modifier at first level, reflecting your intuition and common sense with money. Unlike other ability score-based bonuses, you do not gain or lose Credit modifier as your Wisdom score changes. If at a later level your Wisdom modifier were to increase from +2 to +3 you would not gain any additional Credit, nor would you lose Credit should your wisdom modifier decrease from +1 to +0 for any reason.

Charisma

For most characters Charisma is a measure of one's presence, confidence, charm, and savvy. Some example Charisma specialties include charm, command, and bluffing.

Charisma Checks

A Charisma check might arise when you try to influence or entertain others, when you try to make an impression or tell a convincing lie, or when you are navigating a tricky social situation. The GM might call for a Charisma check when you try to accomplish tasks like the following:

- Appeal to someone's sense of morality
- Overcome another character's influence on a target

Reputation

Your charm and personality go a long way in determining your reputation. You may add your Charisma modifier to your Reputation modifier at 1st level. This is representative of your ability to get more out of your Contacts and Connections.

This bonus is only added at level 1, you do not add it at additional levels, nor does a change in your charisma reflect on your Reputation modifier.

SECTION 03 SPECIES

What you are is as important as what you can do. The galaxy is a place teeming with various intelligent races. On largest space stations dozens of cultures and civilizations collide, languages from across the cosmos fill bustling bazaars. Strange creatures equipped with alien gear create a menagerie of the known civilizations on display. Enigmatic Ephari advisors and human Imperials move through the crowds sure of their authority, while rugged colonials look on. Here and there a Seyvul darts under people's feet busy on some errand or mission, and chittering Ixaxian haggle over the cost of some technological wears. Proud Xhu commanders watch the market for trouble, flanked by hulking Urroru guardsmen.

Yet lurking in the background of these great markets more unusual beings can be seen, alien Thothid moving through the crowd wearing great hooded robes, and barbaric Ba'alur noisily drinking and bellowing tails of their conquests.



SELECTING A SPECIES

Between the Colonials and the Imperium, humanity makes up a huge majority of the galactic community. Yet they share the cosmic star ways with a number of alien creatures, some of whom had been exploring the galaxy for millennia.

The galaxy is teeming with life, yet the majority never reaches the kind of complexity which gives rise to understandable intelligence. Even with those that do, many never become tool using creatures, or are so vastly alien that they cannot be understood through the human lens. This leave those rare few beings so similar in size, shape, temperament, and biochemistry that they can cohabitate - breath the same or similar atmosphere, use tools crafted by other peoples, and most importantly communicate.

The Species you select will determine a number of fundamental aspects of your character, beyond physiology and home world, it can also help inform your choice of class and proficiencies.

Each of the species is very different, with inherent strengths and weaknesses, which can augment some class choices, but the galaxy is a big place, and there is nothing preventing a Ba'alur from becoming a contemplative scientist, or an Ephari a brutal warrior. Though, these might be an unusual choice in their culture. Yet, these could be the foundations of an interesting character, with a deep and compelling history.

Remember it is your character, you create their personality, history, motivations, and goals. Craft a character that is as original or as relatable as you want your character to be.

Species Summery

Ba'alur. Winged reptilian brutes largely considered barbarians, however they have defeated far more advanced races and made their way into space.

Colonial. Humans adapted to alien worlds, descended from the early colonial missions set out by corporations before the advent of the horizon drive.

Ephari. Wandering enigmatic humanoids who resemble early earthly depictions of aliens, born from generations aboard massive world ships.

Empyrean. Genetically engineered super beings that picked up after humanity wiped themselves out in the Sol system.

Ixaxian. Large mantis like beings with a natural predilection towards technology, and an innate ability to communicate via radio frequencies.

Seyvul. Small furry trouble-makers from a back-water world rich in resources who have taken an unexpected place among the stars.

Thothid. Disturbing and arcane aliens who are a mystery even to themselves.

Urroru. Hulking four-armed beast-men who are as much builders and philosophers as they are warriors.

Xhu Akreen. Blue skinned humanoids that once dominated the Arc, until the arrival of the Empyreans.



SPECIES TRAITS

The description of each race includes racial traits that are common to members of that race. The following entries appear among the traits of most races.

Ability Score Increase

Each species increases one or more of your character's ability scores if you select that species.

Age

The age entry notes the age when a member of the race is considered an adult, as well as the race's expected lifespan. This information can help you decide how old your character is at the start of the game. You can choose any age for your character, which could provide an explanation for some of your ability scores. For example, if you play a young or very old character, your age could explain a particularly low Strength or Constitution score, while advanced age could account for a high Intelligence or Wisdom.

Languages

Few peoples in the Arc are confined to simply one language. Your species will indicate the languages you will inherently speak, read and write.

Size

Characters of most races are Medium, a size category including creatures that are roughly 1.3 to 2.7 meters tall. Members of a few races are Small (a meter tall), which means that certain rules of the game affect them differently. The most important of these rules is that Small characters have trouble wielding heavy weapons, as explained in "Equipment."

Speed

Your speed determines how far you can move when traveling through various modes of movement.



BA'ALUR

Lo! What were once the gods of Ba'alur but slavers, cruel masters of the people! In the age of the twilight did the Ba'alur not rise, and topple their gods? Did we not thrust spear and sword through their flesh and lay them low? Did we not crush the bones of the gods!? So too shall we crush the metal sky boats of the invaders! So too shall we lay them low; for if the gods cannot stand against the Ba'alur, how can these naked apes?

- War Cry of Kaikahn, leader of the Ba'alur troops during the Encounter War.

The Ba'alur are a species of hulking warriors who, prior to contact with the Human Imperium, were thought to have a pre-industrial civilization. Yet, in the aftermath of their disastrous first contact, the race bellowed into the space age

aboard stolen and salvaged technology repaired and operated by their shamans. In a sense the Ba'alur are the most naïve race to explore the Arc; still beholden to ancient superstitions and beliefs, as a people they still have only the most primitive understanding of the sciences. But this fact has not stopped them from spreading to dozens of worlds and taking up a place among the intelligent races of the galaxy.

Draconic Brutes

An adult Ba'alur stands nearly 2 meters tall and can weigh up to 90kg. Their broad heads are lined with spines and horns and they possess large membranous wings. This combined with their scaled skin, digitigrade legs and long tails has given them the nick name Dragons of Urkaar (Urkaar being their home world). Each tribe of the Ba'alur possess unique and generally specific scale patterns, not dissimilar from melanin pigmentation in humans ranging from deep brassy patinas to dark back. On their home world the thick foggy atmosphere and high pressure allowed the Ba'alur limited flight - a skill they apply deftly in micro gravity.

Ba'alur are an incredibly long-lived race, with some living to 700 earth years, although it is not considered an honor to die of old age. Still most of the Ba'alur Elders were alive for centuries before first contact, which may be a reason that their culture is so reticent to change.

Shamans of the Star ways

Even after nearly a century of contact with spacefaring civilizations, the Ba'alur hold fast to their shamanic traditions and beliefs. With few exceptions, most Ba'alur believe in an ancient warrior code not unlike the earth ideals of Bushido and Shamanistic animism. Called the Varkahnis, this code was established by the mythological warrior priests that the Ba'alur claim to have killed their gods in ancient times.

This belief in the spirit of the void and the power of honor to overcome spread among the civilized worlds, even resonating with the ancient Xhu Akreen Magisterium, who formally invited them to join as serfs of the Magisterium, under threat of annihilation. This show of strength was something the Ba'alur could respect, unlike the humans attempts at peace.

The ancient Shamans of the Ba'alur home world Urkaar have accepted that their young must venture into the void now that they are part of a larger community, but that does not change that fact that many concepts of advanced civilization seem ludicrous or unimaginable to them.

Ba'alur in other Settings

These aliens are unique in that they're a more primitive culture than most of the civilizations presented in Advent Horizon. Their reliance on magical thinking and superstition in a scientific game makes them ideal for outsiders looking in, or an uncontacted people. How Ba'alur appear in other settings depends on these factors. This could make Ba'alur antagonists in some settings, or they could take on the role of the religious peoples of the galaxy.

Ba'alur Traits

Ability Score Increase. Your Strength score increases by 2 and Wisdom score by 1.

Age. Ba'alur mature through a hatchling stage to physical maturity after about thirty earth years (though less than 10 rotations of their home world). At this point they are considered Ur-Kai and may attempt a rite of adulthood. This is usually a hunting mission or similar trial, should they succeed they are considered adults and may be a part of moots and claim properties and slaves.

Ba'alur Claws. You possess thick sharp claws at the end of your three fingers. The claws are natural weapons, which you can use to make unarmed strikes. If you hit with them, you deal slashing damage equal to 1d4 + your Strength modifier, instead of the bludgeoning damage normal for an unarmed strike.

Ba'alur Resilience. You have advantage on saving throws against poison, and you have resistance against poison and corrosive damage.

Languages. You speak your native Ba'alur dialect and Magoi.

Size. On average the Ba'alur are taller than humans, standing over 2 meters tall and averaging 85kg. Your size is Medium.

Speed. Ba'alur base walking speed is 10 meters. You also may glide under some circumstances.

Thick Scales. You possess thick natural scales which provide you with a natural armor class of 13 + Dexterity modifier while you are unarmored.

Wings. You have thick leathery wings which are used to fly on your home world. In an atmosphere of at least 50 kilopascals (about half of 1 earth atmosphere of pressure) you take half damage from falling. The distance of your long jumps is doubled. With a running start you can fly with a movement speed of 10 meters. You have advantage on Zero Gravity Movement checks and Swimming checks.

Unusual Shape. Ba'alur sport wings, some tail, and digitigrade legs. You cannot use some

equipment designed for humanoids, such as armor, clothing, and seats. Custom fitted armor, clothing, or other such equipment has a +1 Credit modifier cost.

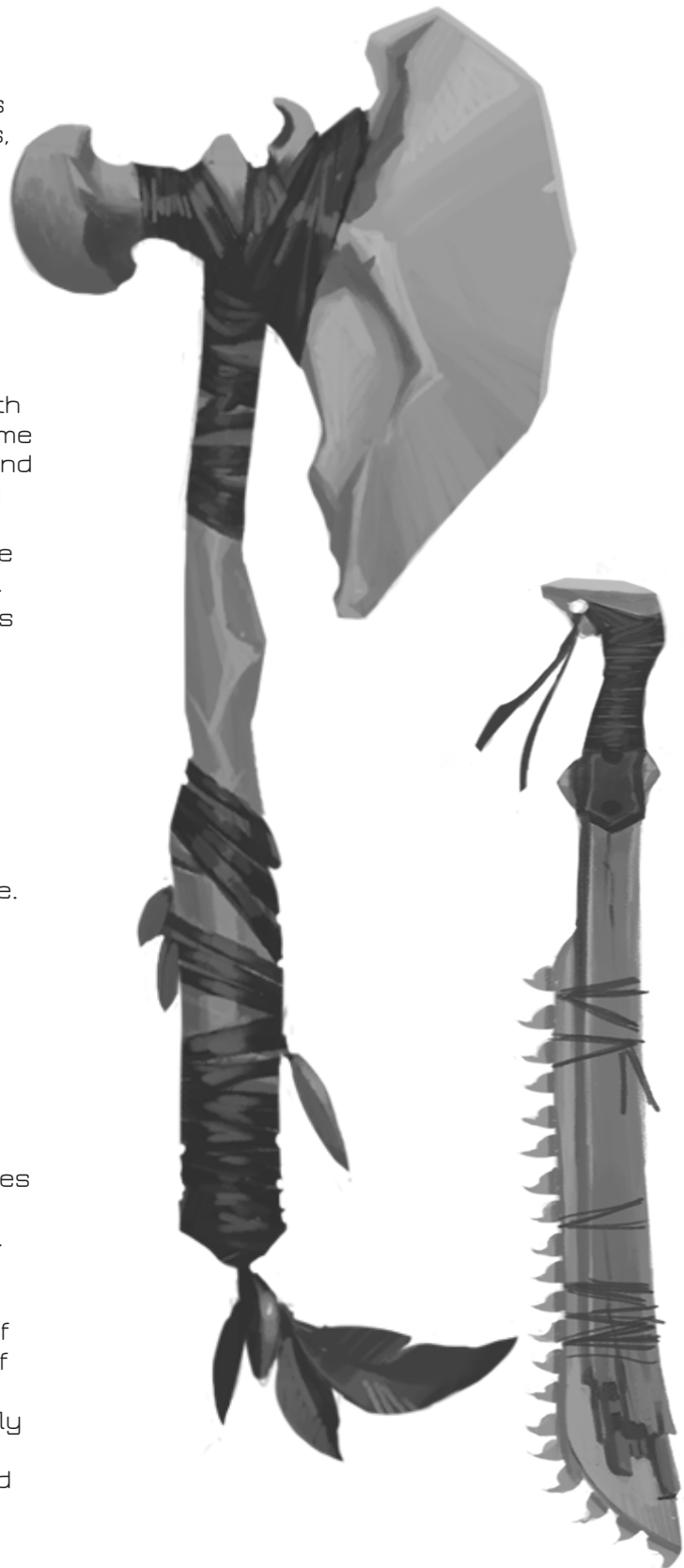

Humanity is an adaptable, capable species, that has spread rapidly to the inhabitable planets and moons that are close to their original home world. Without FTL travel or Q-Bit communication however, these worlds were cut off from Earth, and in time, the pale blue dot was forgotten. But life, and civilization, went on.

After centuries the Corporate Colonies arose as discreet civilizations. Each world, or collection of worlds, became its own culture. Languages changed, genes changes. Forced to adapt to alien biomes, people changed. Humanity became more than humanity faster than any could have predicted, not just through selection and evolution. On dozens of worlds gene therapy and new forms of biotic symbiosis arose. New kinds of humans arose.

Adaptable survivors

Humankind is a uniquely adaptable race. What sets them apart is their ability to survive in biomes that are completely inhospitable. Depending on their home's gravity, most colonial humans stand between 1.5 and 2.2 meters tall and can weight from 50kg to 120 kg. Each colony had its own trials and the various peoples who immigrated from earth crossed the spectrum of cultural backgrounds, this means colonials can range from extremely pail to deep complexions and have hair and eye colors that are equally varied.

The colonies are not earth, and the variations of these biomes have resulted in a huge number of unexpected changes and adaptation. Each human subrace has unique characteristics born of their adaptation to their home world, as discussed below.

Corporate rulers

Even before earth was lost, most colonies were ruled by ruthless corporate dictatorships. With no accountability and no repercussions, corporate governments had complete autonomy. Those that abused this too far were often overthrown in brutal and bloody worker revolutions.

Colonials in Other Settings

The Colonial humans presented here are changed by their respective home worlds. This adds interesting diversity to the otherwise homogeneous human race and can be used as templates for what generations of living in alien environments with different allotropic pressures might be like. After all, humanity has proven to be very adaptable.



COLONIAL

"I've heard the legends of Earth, that mythical blue jewel that mankind fled for money, for greed, for all the reasons you leave a planet behind. But mostly greed. The first corporate colony made Instar Heavy Industries the wealthiest corporation on earth, and wealthier than most nation states. After that the race was on to dupe colonists in to sleeping for fifty years and waking up on a habitable world to be virtual slaves."

- A Colonist's Memoir

Colonial Traits

Ability Score Increase. Your Constitution score increases by 2.

Adaptation. There are hundreds of human colonies, space stations, and out-posts. Rather than list the specific home, you may select from one of the adaptations below. This represent the allotropic pressures of your home colony.

Age. Colonials are still largely human, however, advances in technology have prolonged the life expectancy of many on the more advanced worlds. Most are considered adults by 18 solar years and will live to be 90 to 130 years old.

Proficiency Bonus. You have one bonus proficiency slot.

Languages. You speak and read Colonial Common.

Size. Colonial humans are extremely diverse, ranging from 1.3 to over 2 meters tall, and weighing anywhere from 35 to 120 kg. Your size is Medium.

Speed. Your base walking speed is 10 meters.

Adaptations

Born from generations living on an alien world, you are adept at surviving its specific conditions. Select one of the Adaptations below, this describes the conditions of your home colony, as well as the benefits and drawbacks of adapting to that environment.

Aquatic Colony. You are proficient in Athletics and have Advantage on Breath Control checks. Your swimming movement speed is 10 meters. Your Strength Score increases by 1.

Arctic Colony. You have Advantage on saving throws against cold. You have Resistance to Cryonic damage. Your Strength Score increases by 1.

Arid Colony. You have Advantage on saving throws against fire and thermal damage. You only require half as much water per day. You have Advantage on the constitution saving throw to survive on half water. Your Dexterity Score increases by 1.

Earth Analogue. You have Advantage on all saving throws against disease. Your Charisma Score increases by 1.

High Gravity Colony. You have Resistance to Bludgeoning damage. You gain a +1 bonus to your Strength. Reduce your base height by 50cm. You have Disadvantage on Micro Gravity Movement checks. Your Strength Score increases by 2.

Ionic World. You have advantage on savings throws against electromagnetic attacks. You have proficiency in the Wilderness Skill. Your Intelligence Score increases by 1.

Low Gravity Colony. Increase your base height by 50cm. You are immune to Decompression Sickness. Your movement speed is only 7 meters under medium gravity or higher. Your Dexterity Score increases by 1.

Primeval World. You gain proficiency in Survival. Once per long rest, when you are reduced to 0 hit points you may use your reaction to spend one hit dice and recover that many hit points. Your Wisdom Score increases by 1.

Shadow World. You gain Darkvision out to a range of 60 meters. Darkvision is black and white only, but otherwise works as normal sight. You have disadvantage on attack rolls and on skill checks that rely on sight when you are in an area of bright illumination without eye protection. Your Charisma Score increases by 1.

Stationer. You are proficient in Acrobatics. You are extremely nimble increase your Dexterity Score by 2. You suffer from light muscle atrophy, reduce your Strength Score by 1.

Toxic Atmosphere. You have Advantage on saving throws against Poisons. You have Resistance to Poison damage. Your Wisdom Score increases by 1.

Wasteland Colony. You gain advantage on Constitution checks against starvation and thirst. You have Advantage on saving throws against radiation sickness and are immune to casual radiation exposure. You have Resistance to Radiation damage. You suffer from mild disfigurement, reducing your Charisma score by 1.

From the 22nd Century with love

The original colony ships dispatched from earth took decades to reach our nearest solar neighbors, others took centuries. Expeditions to worlds more than 100 light years away took almost a thousand years - meaning there are still ships from earth out there, in the void, hurtling towards a future that they could never have predicted.

Some colonies are only a few decades old, and still buried in the mindset of the Earth of the 22nd Century, complete with their capitalist ideologies, reckless attitude, and nationalistic prides. It's a hard thing to swallow knowing that the world you were born on no longer exists.



EPHARI

"We dreamed a waking dream. We dreamed of the void, of the ocean of stars, of world upon world that we were never to visit, never to know. For ours was a course laid out many eons ago by ancient law - immutable and unchanging were we. Dreamers, awake and adrift. Until we came upon you. Now we dream no longer."

- Ancient record of the Ephari Encounter

First extraterrestrials to contact humanity, shortly after the original Horizon Drive was tested. While the records of this encounter, and the hundreds of years between the time the original colonial ships leaving earth and the emergence of the Imperium, are now lost. It is evident that the Ephari, or at least their technology, played a pivotal role in the Imperium's creation.

But who, and what, the Ephari really are remains a mystery. They have no known home world, and are birthed aboard an enormous generation ship that, before mankind's breakthrough, traveled the cosmos at merely relativistic speed.

Ephemeral Strangers

The Ephari are willowy, thin and elegantly tall creatures, with large oversized heads and eyes, but their physiology resembles humans to an improbable degree - much as the Xhu. The Epharis are especially adapted at low gravity movement, with the long limbs and delicate structures. Most stand 2 meters in height yet rarely weigh more than 60kg. display sexual dimorphism, although they demonstrate no reproductive capability.

Ephari procreate asexually through artificial facilities aboard their massive ship. A new Ephari is born when one is confirmed to have died through injury or illness, or when a specific need is identified within the community of the ship needs to be filled. Though this strict population control is no longer essential for their survival, their culture has been slow to adapt to their new circumstances.

Ancient Wanderers

For millennia the Ephari knew only the depth of the void. They drifted a course through the cosmos, journeying from star system to star system on a seemingly endless journey, their course predetermined in the ages before they embarked towards it. So, obediently and with great care the nameless race journeyed, ever onward.

Most did not question their place aboard their ancient ship, or the teachings of their people. By all accounts they have been wanderers drifting in the vast interstellar void for thousands of years. Humanity, and the Horizon Drive changed this, and suddenly the ancient wanderers were no longer tied to the chains of relativity.

In their time among the stars the Ephari cultivated a unique philosophy, practice of meditation, and sciences unlike terrestrial races.

Ephari in Other Settings

In a way Ephari make the perfect alien for settings that take place in more contemporary future. The arrival of their world ship before humans became a galactic civilization could have changed the course of history.

Ephari Traits

Ability Score Increase. Your Wisdom and your Charisma score increase by 1.

Age. Most Ephari reach maturity around 25 solar years of age and will live for a little over 200.

Alien Senses. You can't be surprised while you are conscious. Other creatures don't gain advantage on attack rolls against you as a result of being hidden from you.

Esper. You have proficiency in the Telepathy skill. For more on psionics see section 11.

Languages. You read and speak your native Ephari, and Imperial.

Purpose. The Ephari are made, not born. Each is cultivated in the depths of their ancient WorldShip to serve a purpose and fulfill a role in Ephari society. Select one Intelligence or Wisdom Skill – regardless of why you are an adventurer, this skill represents the role you were meant to, and perhaps still do, fill in the universe. You have Advantage on all skill checks under this skill.

Size. Although somewhat delicate your size is medium.

Speed. Your movement speed is 10 meters.

Ephari Mystery

That the Ephari know so little of their origins and mission is an accident, and not a choice. Thousands of years ago a bloody civil war shook the Ephari WorldShip. The separatist forces destroyed the Ephari's ancient libraries and murdered the high council. The Separatists fled to an inhabited planet near the course of the WorldShip, but the damage left an irreparable scar on the Ephari culture. They lost their leadership and history to the conflict, and the damage to the WorldShip was never fully repaired.

What became of these rebels is unknown. It is presumed they lived and died on that alien world millennia ago, as they had no means to reproduce. Still, the legend of these violent aberrations continues to exist in the Ephari subconscious, a specter of the past that haunts the old and is used to teach fear of disunity to the young.





EMPYREAN

Weather and wars, burning storms, famine and fear. This is how the system came to an end. The poor and unwanted were abandoned, the rich, powerful, and those that served them fled to the outer colonies.

We remained. We the Perfected. We are the burning resurrection that emerged from the ruins of Sol. While our scattered ancestors fled to other worlds, we remained to rise. They had created us to be the superior, to be what they would never become. They thought we died with Earth and Mars, we did not, and now we are the Empyrean.

- Historia Imperious

The Empyrean are not humankind like you and I, but something different. Something with more of our strengths, and fewer of our weaknesses. Born from the super soldiers created at the end of the last era, these beings were modified to be stronger, faster, immune to diseases and radiation, but never meant to be able to breed, and created to be controlled. In the aftermath of the atomic wars that ended civilization in the sol system, these soldiers evolved.

Mankind, Perfected

In the final days of the old-worlds, artificially enhanced genetically isozymic soldiers fought over the dwindling food, water, and air. At the end of the 23rd century nuclear war erupted between Earth and Martian powers. As the scattered peoples of the solar system looked on in horror, the inner planets burned bright in nuclear fire, and fell silent. As the worlds ended, there were several unique models of genetically recombinant soldiers, each purpose engineered to a specific task. Most survived; they needed less air, less water, and resisted radiation and disease much better than humans.

Modern Empyreans stand between 1.6 and 2 meters tall, and eight 60 to 100 kg. Their coloration is generally a tawny tan, with some lighter or darker variations occurring but not common, their hair is usually dark brown or black, though pale brown can occur. Empyreans are created from a small selection of genes, and although mutation happens, they have far fewer recessive and anomalous genes than other humans.

The Imperium

All empyreans are members of the most powerful human civilization: The Imperium. This strict meritocracy arose from multiple competing cultural and economic bodies but was driven by the powerful Earthly Emperor, the semi mythological figure that united the remaining survivors of Rex Terra and awoke those that had not been activated. As the last humans died out, the Empyreans rose to power.

Though Empyreans had conquered and colonized the Sol system, the creation of the Horizon drive marked the birth of the Imperium in earnest. Industrious and determined the Horizon Drive rapidly advanced the Imperium to a level of civilization only matched by the Xhu. With this one breakthrough the balance of power in the galaxy shifted. Suddenly the supremacy of an ancient alien race was in threat, and no one yet realized.

From the edge of the galaxy and a forgotten world came a fleet that could cross lightyears in days and would change the nature of space travel forever. First, they encountered the Ephari, then they came for what they believed was owed by right: The Colonies.

Empyrean in Other Settings

The Empyrean are the perfect template for a refined spacefaring humanity, especially one that has eliminated most of their weaknesses and flaws and has reverted to aristocratic merisms. Perhaps they are the decedents of genetically engineered colonist sent to a distant and inhospitable world, or the creation of humans who tinkered with the building blocks of life.

Empyrean Traits

Age. While Empyreans reach physical maturity in 18 to 20 years like normal humans, they are not considered adults and citizens of the Imperium until they are 35. To date, the oldest Empyrean lived to be over 500 years old, having been created during the Final War.

Languages. You speak and read Imperial and Colonial Common.

Perfected Abilities. Increase your Strength, Constitution, Intelligence, and Charisma ability scores by 1.

Perfected Resistance. You have Advantage on saving throws against Disease, Radiation, and Poison.

Perfected Stamina. Owing to your engineered genome, you have superior stamina and have advantage on all saving throws against exhaustion. Following a long rest, you recover from 1 extra rank of exhaustion.

Perfected Proficiencies. You have 1 bonus proficiency slot.

Size. Empyreans are almost identical to colonial humans. Your size is medium.

Speed. Your base speed is 10m.

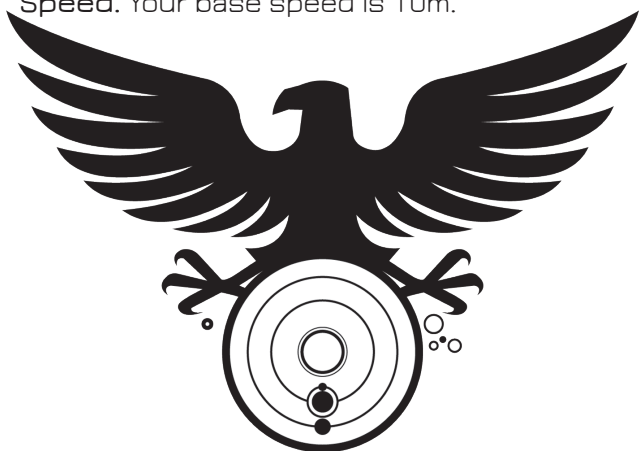

Humans of the Imperium

The Empyreans are not human. Mutation and Engineering have created a completely new species. An Empyrean will view a human much how humans view chimpanzees. Clearly, they're related, but the distance seems insurmountable.

Moreover, rumor persists that some fraction of the population may have survived the Final War, and that it was the genetically superior soldiers that engaged in a massive campaign of genocide across the solar system, hunting the tattered remnants of humanity to extinction.

Something changed when the Empyrean's encountered the Ephari, something tempered them. Certainly, the people of Higil did not see the Empyrean armada as a unifying force, but as a dark horse, harbinger of the end of their civilization.

Still humans make up the majority of the Imperium's workforce and polity, even though the colonists live as second class citizens. As the oldest colonies these worlds have the most pronounced adaptations.

Higil. An Arid Colony.

Huoyi. A Low Gravity Colony.

Proxima Colony. A Shadow World.

Aegeris. A Primaeval World.

Cygni. An Arctic colony.



IXAXIAN

"What do you mean that we offend you? You say that your race has annihilated segments of your population, not once, but multiple times! And you destroyed your home world with atomic weapons! What else would you expect our word for you to be other than 'Terrors from the Sky', you humans are the stuff of fear and death.

Remarkably adaptive and curious, during the rise of their industrialization - their steam age - the Ixaxian people realized that their little world was under the great eye of minds both powerful and alien. So, they vowed to progress their sciences in a quiet and peaceful way, one that was slow, steady, and rational.

So silently, on the edge of the galaxy, a thousand-year plan was enacted by a race that had the potential to become so much more. Sciences were explored deep in the earth, while life above progressed at a slow, but meaningful rate. Nuclear technology, antimatter, heavy atom collisions, all done with never an obvious show. Until a Xhu dreadnought stopped in their system to refuel.

Mantis of Ixax

These creatures resemble enormous mantises, with four legs for mobility, and two arms with dexterous manipulators. Thick grey black exoskeleton covers them, and this chitinous armor segments around their mobile thorax like tail and joints. Their two large black eyes provide an increased field of vision, and two antennae like protrusions give them a superior sense of smell and air vibrations. Though they resemble earthly insects, they are bulkier, and have internal multi-chambered lungs, as well as complex nervous systems.

Like earthly insects, the Ixaxian will molt multiple times in their life, generally once every four to six years until they reach maturation at fifteen to eighteen solar years. This last molting is called their "tzzac'tk" or finally. Afterwards the Ixaxian will no longer grow, and their chitin patterns are fixed.

Children of the Hive

On first encounter, many believed that the Ixaxian possessed a hive mind, though this is not true. The Ixaxians possess a limited ability to communicate through short bursts of radio signals between 1.8 and 2.6 GHz. This is not a primary form of communication. For an Ixaxian the signals are resembling facial expressions or body language or even scent, something that adds nuance to language. Yet, like sign language, some sub-cultures developed this ability into extremely effective means of communication and even methods to interface with technology.

Ixaxian techno-cant is most effective at expressing mathematical and logical process information. This lets Ixaxians constantly share their understanding with peers, allowing information to transmit with shocking alacrity among their people. In a sense, they do have a hive-like connection, with information and solutions disseminating among the population in bursts and pulses.

Ixaxian in other Settings

These curious, industrious, and capable creatures make an interesting addition to galactic space operas and settings in which the truly alien is not feared and shunned. In more contemporary settings Ixaxians may be seen as too alien and xenophobic to co-exist with setting the stage for interstellar drama as the powers of earth argue for a first strike in what would be a long and devastating war.

Ixaxian Traits

Ability Score Increase. Your Intelligence score is increased by 2, and your Dexterity score by 1.

Age. An Ixaxian will reach physical and mental maturity in around fifteen solar years, and live for fifty to eighty solar years, sometimes longer.

Chitin Carapace. You have a thick hard carapace, giving you a natural armor class of 13 + Dexterity Modifier while you are unarmored. Because you have a strong exoskeleton, you are also highly resistant to extreme gravity and depressurization, gaining Advantage on Decompression saving throws and doubling your G-tolerance. Finally, you have Resistance to Thermal and Cryonic damage. Collectively this allows you to operate in EVA without a full space suit.

EM sense. As an Ixaxian, your antenna can pick up and emit localized radio and electromagnetic frequencies. This gives you a number of abilities. In addition to communicating with other Ixaxians and potentially some special devices, this sense gives you Advantage on checks when building, repairing, modifying, or bypassing electronics.

You can also feel when devices nearby are emitting wireless signals. While you cannot understand or interpret digital noise, you can detect it. This gives you the ability to locate and the offending radios or computers within 5 meters. Unseen attacks who are emitting such signals lose their advantage against you, because you can feel their location and distance.

Languages. You speak and read Uxian, and one bonus languages of choice.

Multi-limbed. You have four powerful legs that allow you to navigate difficult terrain on land with no movement penalties. Your powerful hind legs allow you to perform amazing leaps (three times strength modifier for a long jump, or 1m + 0.3m per point of your Strength modifier, minimum 1, for high jumps). You have advantage on Climbing Checks.

Size. Ixaxian stand around 1.3 meters at the head, and close to 2 meters at the tip of the tail. You are a medium size creature.

Speed. Despite having four legs, you are not noticeable faster than other races. Your movement speed is 10 meters.

Spectrum Vision. Ixaxian eyes are large and have a huge field of view in a spectrum deeper than most other creatures. You have advantage on visual Perception Checks and can see into the low ultraviolet spectrum.

Unusual Shape. Ixaxians are not humanoid. They are large and quadrupedal, with thick spiny exoskeletons. You cannot use most equipment

designed for humanoids, and have trouble piloting any machines built for humanoids, suffering Disadvantage. You can only use weapons, arm mounted equipment, belt mounted equipment, harnesses, and back packs. Custom fitted armor, clothing, or other such equipment has a +2 Credit modifier cost.

Ixaxians who are knocked prone have significantly more trouble standing than bipeds. Standing from prone costs all your movement for your turn, and you cannot crawl while prone.



Corporate Sponsors

Ixaxians are the most technologically advanced species in the Arc. Without them, the Colonists would likely have never been able to hold out against the Imperium or the Magisterium. As a result of exposure to the Ixaxian advanced technology, humans were able to quickly adapt and develop in ways that shocked the cautious creatures.

The Colonists were willing to risk everything to explore and expand and proved capable of reverse engineering any technology they were given. This also meant the Ixaxians needed to find a way to keep the colonists in line. Luckily for them the humans had built in power structures for the Ixaxian's to exploit, leading to a number of wise investments that gave Ixaxians majority control of most of the allied corporations. Despite this, the Ixaxians are a socialist culture, with no currency or form of capitalism.

The Seyvul evolved on a world with a bounty of natural resources, and following a mass extinction event, became the dominant species and developed intelligence. But for these creatures there was never a competition for resources, so the kinds of territorialism that arose among similar organisms never developed among these small furry creatures.

Fox in the Henhouse

The first encounter of the Seyvul compared them to an earth animal long thought extinct called a fennec. These beings stand at most 1.2 meters tall, and rarely weigh more than 35 Kg, entirely covered in fur that can range from black to white, with spots, stripes or ranges of red and yellow, the Seyvul run a colorful gamut in their appearance. What all have in common is a long almost canine snout and jaw, very large ears, and four optical organs that adorn their heads.

Naturally, humankind found the creatures, with their childlike naivety and appearance, extremely adorable. Until the Seyvul began to 'borrow' the Colonist's equipment. After quickly reverse engineering the EM drives the Seyvul commandeers several colonial ships and set out to explore their own solar system. Thirty years later, all the ships were abandoned in orbit around their home planet of Erswe. It caused a serious issue.

Owned by None

Upon first contact, the species had been in a strange kind of postindustrial civilization with a progress that baffled the humans - they had learned about and subsequently abandoned many kinds of technology - including fossil fuels, nuclear power, and artificial intelligence. Instead they had focused on programable matter and renewable resources. Most lived simple agrarian lifestyles, yet all had access to advanced communication, and a kind of universal income and community call the Share. No Seyvul "owned" a thing unless they literally had it in their possession and were using it. But as soon as a tool or resource was set aside it ceased to exist, became free, became part of the Share.

They would sleep where they were found a nest, ate where they found food, picked up and left tools the moment they were done with them, or in many cases invented and developed a tool or technology to solve a problem, then, abandoned it. It was incomprehensible to the colonists who first encountered the creatures, and tried to teach them ownership, property, and similar notions. These were understood fully and promptly ignored. No one on Erswe ever had



SEYVUL

"No no no human Joe, me Jarak did not steal. You left the control card on your bed, clearly you did not need it. It is gift to Jarak then, because you did not need it like me, and is now mine. I will not give it to you yet, as I still need the Starship."

No race has infuriated the galaxy nor proved the fallibility of the supposedly superior races as often as the Seyvul. First encountered by second generation corporate colonists transported aboard Ixaxian freight, the Seyvul proved to be an intelligent, empathic, and highly capable race. With absolutely no concept of personal property, personal space, decorum, or manners. The creatures are compulsively honest, and while capable of solving complex technical problems with little challenge, have troubles with why many creatures are so averse to sharing.

to worry about hunger or homelessness. Those who loved knowledge and research were free to pursue it as they saw fit, and they could generate capitol for research simply by conversing others to contribute.

Seyvul in Other Settings

These curious mischievous creatures make an interesting first contact option in other settings. The unique social communism and technical advancement make integrating them into space operas easy, and their strange outlook and alien behavior can add to their contribution to a more grounded setting.

Borrow, not Steal

While Seyvuls tend to take things that don't belong to them, they don't keep them for long, and don't hoard things. In fact, the idea of "owning" something larger than personal jewelry is absurd to these creatures. You cannot "own" a portion of a planet or a ship which required the work of hundreds or thousand to build, it's ridiculous. For a Seyvul to own implies a deep personal intimacy. A Seyvul owns their thoughts and ideas, their feelings, and imagination. By extension, the only things that a Seyvul will think of as theirs are things that they meticulously craft that shows who they are, but not things like tools, food, or resources.

When a Seyvul thinks they won't need something again that day, they will drop them, or give them to their friends. In Seyvul communities there is usually a store house or common house that is used for the share.

Seyvul Traits

Ability Score Increase. Your Dexterity score increases by 2, and your intelligence score by 1.

Age. A Seyvul matures at around twenty solar years but may live for close to a century.

Languages. You speak and read Fennish and Colonial Common.

Multi-Spectrum Eyes. Seyvul can see deep into the ultraviolet and infrared spectrum. This gives you thermal vision to a range of 30 meters, and Darkvision to the range of 90 meters. You can see through all known methods of optical camouflage. You have Advantage on any rolls to visually detect hidden persons or objects.

This also allows you to see things that you may not have thought of, if someone has a fever or high temperature, or is very cold, you will know. You can see targeting lasers and the infrared beams of motion sensors and remot controls.

Size. Most Seyvul stand between 1 and 1.5 meters tall and weigh less than 50kg. Your size is small.

Speed. Your speed is 8 meters.

Quick Feet. As small creatures, when you take the dodge action in combat you add an additional +2 to your armor class against medium or larger creatures in melee range, and +2 to your armor class against all ranged attacks.

Quick Hands. Seyvul are notoriously sticky fingered and quick hands. You have Advantage on Dexterity (sleight of hand) checks.

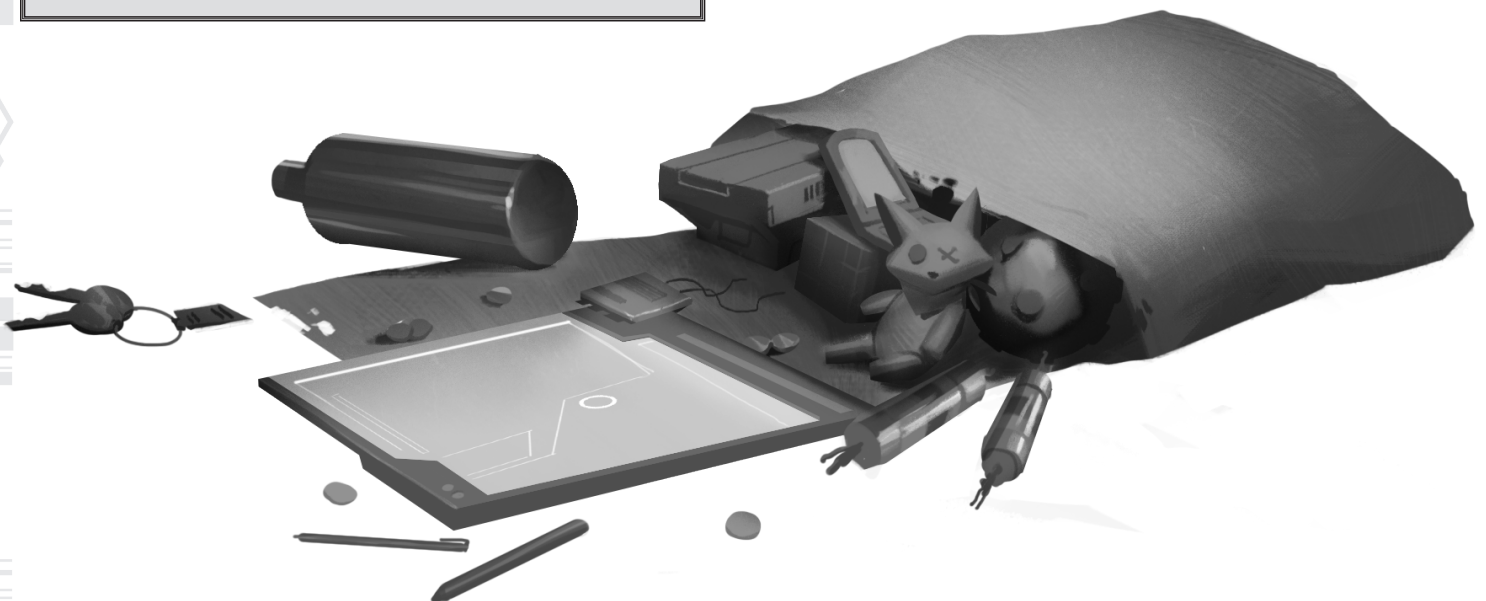



THOTHID

"We live on a placid island of ignorance in the midst of black seas of infinity, and it was not meant that we should voyage far."

Perhaps ignorance is bliss, in so far as to the truth and nature of the Thothid. These creatures are by far the most alien and disturbing of any of the intelligent races that have populated the sea of stars. In eons past, the Thothid served to enlighten and elevate the Xhu Akreen. Bringing them from an industrial society into the position of dominion over the whole of the galaxy. Yet, as the regency of the Xhu spread, the Thothid receded to the shadows of the galaxy.

The arrival of humanity in its varied incarnation seems to have set something in motion. Amid a

tense galaxy, these alien beings returned from ancient legends to once again offer guidance to the Xhu Akreen and take up again their place in the Magisterium.

Eldritch Horrors

The Thothid resemble the kinds of nightmares ancient authors and thinkers of earth feared may lurk deep in space. Very little is known about these creatures in a mature state. The adolescents are upright and bipedal, the heads of the Thothid resemble a bony cephalopod, with eight to twelve front facing tentacles that range between 0.3 and 1 meter in length. They have six eyes that form a ridge up their head with bifurcated pupils. These gaunt creatures stand between 1.6 and 2.2 meters tall, and often weigh more than 70 kg. Their two large membranous wing limbs are often draped around themselves like a robe. Their hands feature six bony elongated fingers.

Thothid possess multiple biological life cycles, their larval stage and their fully matured stage are closely guarded secrets. In their adolescent stage they are sent to explore the galaxy and serve the Magisterium. Young Thothid are not privy to the secrets of their people, only the vague warning that as they reach the end of their adolescents (after nearly two hundred solar years) they will be judged. The worthy will progress into adulthood.

As the Thothid matures, its wings expand, and it continues to grow. Older adolescents are well over 2.5 meters tall, some taller. They also grow much darker with patterns of dark blue or navy being reported, as well as green or red highlights.

A Dark Star

Thothid hate the light, and most of their colonies are found in orbit of dim, dying stars. Here, the adults will craft tools and ships from a slurry of biological material and bacteria sized organisms that are programmable and can replicate most advanced machines. Thothic Armors and Weapons are rare however, and generally not gifted to the young sent out on missions for the greater purpose of their people. When one does receive these weapons they are keyed to that individual, rendering the organism useless if stolen, or looted.

Their mysterious nature, and the fact that even their emissaries are ignorant as to the nature or intent of their civilization has created all kinds of rumors surrounding their goals, and their origins.

Thothid in other Settings

Thothid are a unique race in that player character Thothid are often not privy to the secrets of their people. In other settings lone Thothid diplomates and spies could have ulterior motives on a near future earth or be the harbingers of grave danger in a fantastic space opera. These immature Thothid adventurers could be forced to choose between their companions and their people.

Thothid Traits

Ability Score Increase. Your Intelligence and Wisdom score increase by 1.

Age. Unknown. Thothid adolescence emerge mature from a kind of pupa and after at least twenty years have reached the necessary mental maturity to be assigned a role in the Thothid arm of the Magisterium. How long these creatures live is unknown, even to the adventuring young.

Esper. You have proficiency in the Biomanipulation psionic ability. For more on psionics see section 11.

Languages. You Speak Magoi and Quithal.

Regeneration. The adolescent Thothid possess remarkable regeneration ability. At the end of your turn you may take a bonus action to regenerate 1 hit point. You only have one bonus action each round and may not heal if you have used your bonus action prior to this.

Size. Thothid stand 2 meters or taller and can weigh more than 75kg. Your size is medium.

Speed. You have a movement speed of 10 meters on the ground, and 5 flying.

Tentacles. You have eight, ten, or twelve front facing prehensile tentacles. These limbs are usually too weak to be used in combat (1/4th Strength and Dexterity Score) but can hold items, and give you advantage on attempts to grapple. The number of tentacles you possess has no bearing on this bonus.

Wings. You have two leathery wings, primarily used for aquatic movement. These appendages allow you to swim with a speed of 10m and fly with a movement speed of 15m in pressurized micro gravity. You have advantage on Zero Gravity Movement checks.

Alien, even to yourself

The Thothid are one of, if not the oldest species, in the Arc. According to the Protogen Archives, the Thothid represent a civilization more than two and a half million years old. This makes the mystery of their aims and ambitions only deeper. With millions of years to expand and advance why aren't they ruling the galaxy? The young have no answers.

When a Thothid emerges from its larval state it is developmentally similar to an adult human, but devoid of education or language. Their first years are spent in a kind of school that teaches them of their place in Magisterium society, and their expectations. Here very old Adolescents and Xhu Akreen raise them up, and after a decade they are discharged, often to pursue an education or career that they gravitate towards.



Beasts of Urous

The Urroru are native to a world with high gravity, a thick atmosphere, and freezing winters - Urous. Like all the life on this world they developed a hexapod form, with six limbs. Two powerful legs, two large powerful arms, and then a secondary set of arms with fine manipulators. An adult Urroru stands between 1.8 and 2.5 meters tall and boast a thick coat of wooly fur. Most can weight more than 150 kg.

An Urroru's face sports a short snout framed by two dark eyes above a mouth filled with sharp teeth and two pronounced mandibular tusks. Though fearsome in appearance, as a people these creatures prefer building to battle, a legacy of the Urroru's place among the Xhu or an evolution, it is impossible to say.



URRORU

We serve the Xhu for they have elevated us, enlightened us, and defined us. For a thousand years, we have served the Magisterium. For a thousand years we have been loyal. And we shall be for a thousand more.

Many millennia ago, the Xhu encountered the Urroru as a primitive race on the edge of the galaxy. The Xhu in arrogance thought little of the savage peoples as the established a colony on the Urroru world. When the tribes gathered and retaliated for the violation of their territory, the mighty Xhu were caught wholly unprepared. Although a temporary victory, it proved to the Xhu that the Urroru were a formidable force, when motivated. So, the Urroru were offered a truce: in exchange for eternal servitude, the Xhu would elevate the Urroru to that of an interstellar civilization.

Since then, the Xhu have kept their word, the industrious and robust race was integrated into the production and military of the Magisterium, becoming the chief architects and engineers of the Xhu's vast fleets.

Hammer of the Magisterium

It cannot be said that the Urroru are equals in the empire of the Xhu, but they are not slaves. And for the most part they have expectations and rights fitting their station - they are the crafters and builder of the galactic community. While no Urroru would rise to the rank to command a ship or fleet in the empire, they are free to command industry or business, and many of the generation families of these creatures exorcise as much power in the Magisterium as any Xhu aristocrat.

They are also employed in the military as shock troopers for boarding and landing groups. This has created a dichotomy among the people, who see themselves as the builders and protectors of the largest civilization in the galaxy.

Urroru in Other Settings

These industrious, capable creatures make an interesting piece of a setting in which a humanity is new to the stars, or one where mankind is still locked in our solar system. A lone explorer or merchant might find earth with its comparatively primitive and young race and decide to investigate.

Urroru Traits

Ability Score Increase. Your Constitution score increases by 2 and your Strength score by 1.

Age. Urroru mature slowly compared to the other races. Most are considered adults around 50 solar years, with the average life expectancy to be around 300 solar years.

Arms. Your upper arms are primarily used for lifting and climbing, and end in thick claws. On your turn you may make an additional unarmed attack with your claws against a target within 2m. Your claws deal 1d4 slashing damage on a hit. Having four arms also provides you Advantage on Grapple checks, and Advantage on Climbing checks.

Cold Resistance. Urroru can survive freezing temperatures. You have Resistance to Cold.

Languages. You speak Magoi and one bonus language of choice.

Toughness. Your hit points maximum increases by 1, and it increases by 1 every time you gain a level.

Size. An Urroru might reach 2.5m in heights and weigh will over 100kg. Your size is Medium.

Speed. Your speed is 10 meters.

Gentle Giants

The greatest merits in Urroru culture are craftsmanship, patience, and solidarity. These creatures view martial prowess with resignation, not respect. Being a maker is viewed as the highest honor, while being a warrior is viewed as a sad, life.

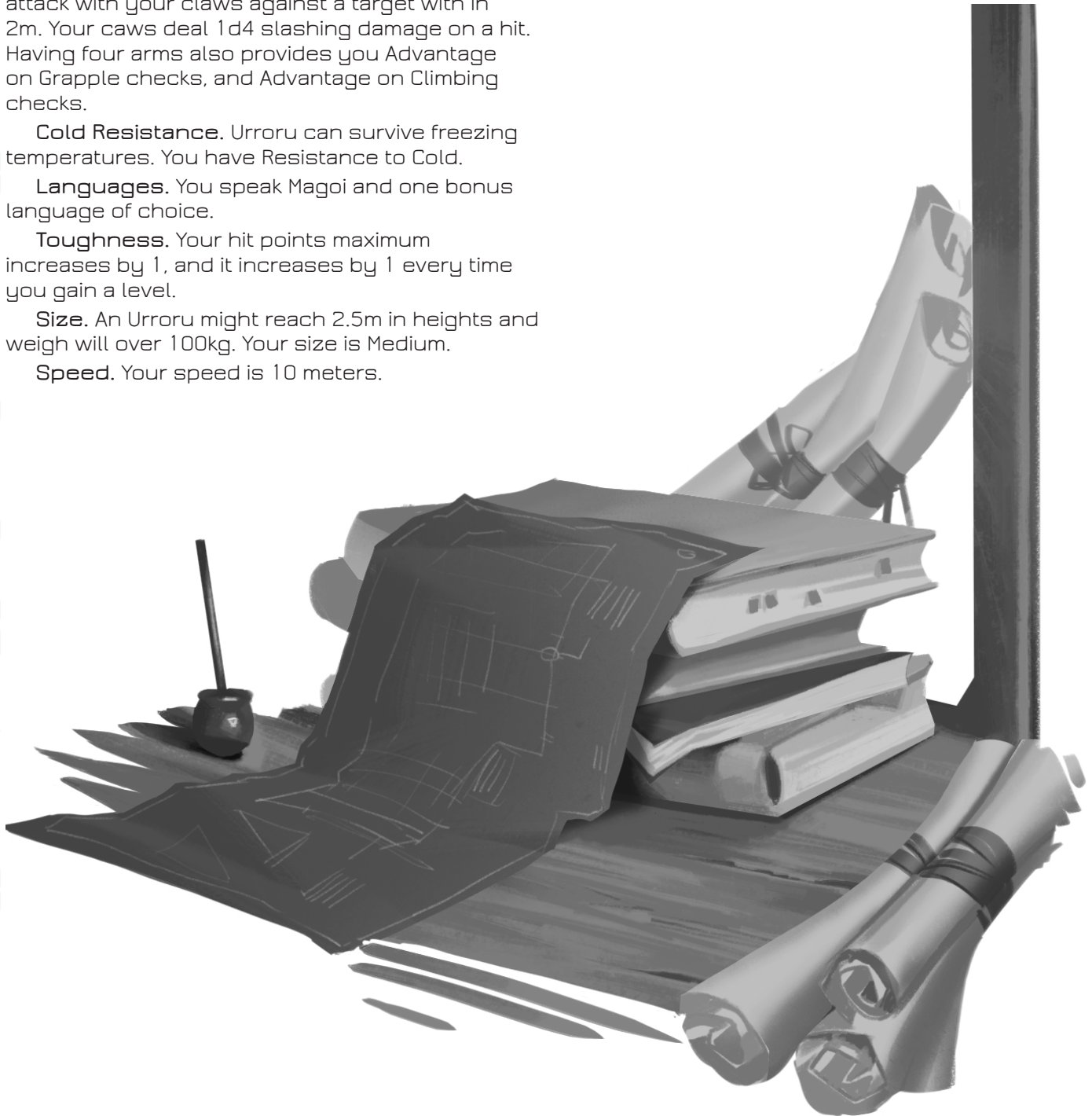



XHU AKREEN

When our star was young, the Old Ones brought us to a barren world, and said, "sow life as we do". And we did. When Our world bloomed like none other in the cosmos, they returned and said, "fight the darkness, as we do". And we did. For an eon, we would wage war against the timeless and the unknowable, until once again the Old Ones came and said, "Our time has come. You must protect the galaxy, as we did". We looked then upon the stars, and said: We have become the Ancient.

The empire of the Xhu Akreen, known as the Magisterium of the Congress, has been a space fairing culture for between fifteen and forty thousand years. The first signs of Akreen architecture in the galaxy stretch back over forty millennia, but the canonical history of the empire begins with a granite slate etched with the covenant of the stars, commanding the congress of the 'Xoho Ahkreen' to guard the galaxy against some nameless threat and watch over the highly coveted network of stable wormholes. That stone is between 13 and 14 thousand years old.

Impossible Similarities

Xhu Akreen resemble hominids to an improbably degree, standing 1.7 to 2.2 meters tall and weighing 100 kg on average for an adult male. These physically imposing creatures are hairless, and have skin that ranges from deep purple to a light blue. Otherwise their characteristics closely mirror humans - ears, eyes, five fingered hands and toes. Even similar organ structure, although Xhu blood is blue-black when it oxidizes, unlike that of humans.

These similarities did not go unnoticed, even in so far as many Xhu colloquially believe the humans are some kind of reverted cousins, maybe decedents of some lost colony or Pre-Magisterium expedition. The physiologic and genetic differences are extreme however on closer examination. Xhu have levels of silver in their bodies that would kill a human. They are extremely resistant to microbial infections and radiation and appear to have no natural Hayflick limit (the number of times their cells can divide before they die). Yet, the biosphere of the Xhu home world of Yehai is abnormally like Earth's.

The Endless Empire

Stretching from one corner of the galaxy to the next, the Magisterium of the Xhu Akreen has ruled over known space for thousands of years. This is all the more incredible when you consider that they never exactly developed faster than light travel, only a kind of quantum entangled communication and the technology to exploit naturally occurring spatial anomalies to travel thousands of light years quickly. Every technology, structure, and law had to be built in a such a way as to survive for a thousand years or more. Thus, was the way of the Endless Empire, an empire of ageless stone and millennium vessels.

And for all those ages the superiority of the Xhu was never questioned. Until the arrival of the Emypreans and their ability to travel the vastness of the cosmos in an instant. Shattering the ancient paradigms of the Magisterium, the greatest power in the galaxy was suddenly forced to change.

Xhu Akreen in Other Settings

What the Xhu represent is the guard left by the first races of the galaxy. In other settings one might see their civilization as the antagonists and players as anti-heroes, or they could as a whole represent the established authority and governance of a galactic community unified by their predecessors.

Xhu Akreen Traits

Ability Score Increase. Your Strength, Constitution, and Charisma score increase by 1.

Age. Xhu are considered “Ke’hi”, innocent, until they are 22 solar years of age. At this time, they take part in a ritual of adulthood, depending on their specific Regency (family or house). Xhu do not noticeably age after reaching an age of about 40 solar years and tend to retire after 700 and live for another century or so.

Endless Education. You have practiced many skills and gain 1 proficiency slot.

Endless Endurance. Once per long rest, if you are reduced to 0 hit points, but not killed outright and not subject to further damage, you instead are reduced to 1 hit point.

Endless Immunity. You are immune to infection and disease and have Advantage on saving throws against Radiation.

Languages. You speak Magoi and a number of bonus languages equal to your intelligence modifier.

Size. You are medium sized.

Speed. Your speed is 10 meters.

Rank and Regency

Because of their complex diaspora, the Xhu have several independent ruling structures, called regencies. Each regency is its own political and economic power, and each has a separate form of government, with most some flavor of democratic meritocracy.

Ai Kin Ka. The House of the Ai, or the first ones, is said to be the oldest Regency. They hold most of the control on Yehai.

Anu Ar Ke. The regency of shipwrights, know to build maintain and man the great fleets. They have long held the secrets of the ancient Gate network.

Anup Ane. A regency of farmers and agrarians, they are also masters of terraformation, who claim to have been the original workers that turned Yehai from a barren rock to a garden world.

Killa Ke. The Regency most commonly associated with scholars and history, the Killa Ke man and maintain the great Protogen Archives, and often travel as the census takers of the magisterium.

Koho Ke. The regency of stone workers long made and maintained the monoliths that were paced on Magisterium worlds. They also served as the caretakers of the quantum network.

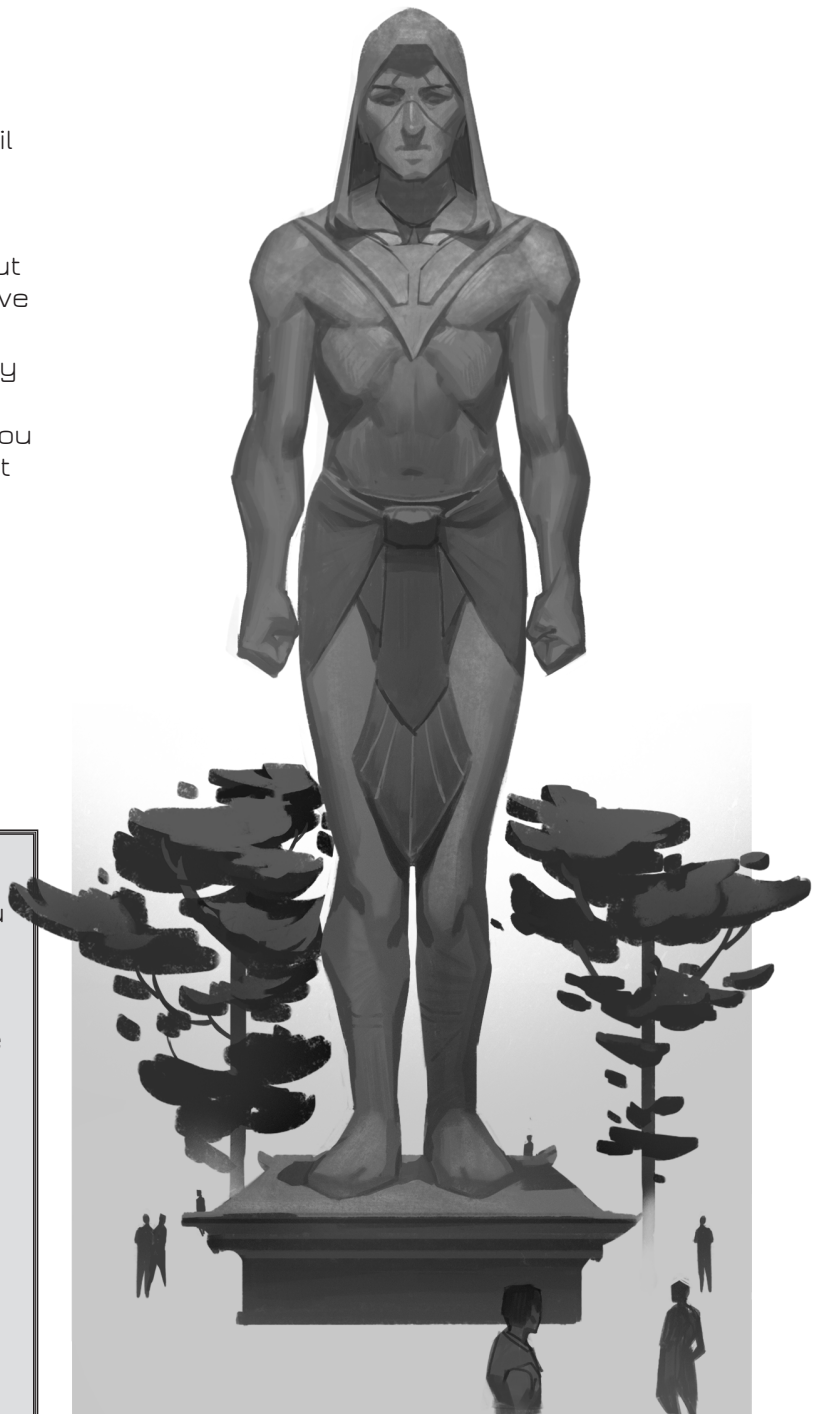

OTHER SPECIES

The intelligent beings described above make up only a small selection of the alien life in the galaxy, but they are the most common, and most wide spread. The Horizon drive has allowed for the discovery and introduction of dozens of intelligent organisms from across the arc, but these beings remain few, and far between.

SECTION 04 CLASSES

Player characters in Advent Horizon represent the extraordinary - people with the ability to rise above and change the course of history. These adventurers have the will to face unknown and unknowable mysteries in the depths of space, delve into ancient alien ruins, and explore the edge of the galaxy.

Your class is one of many mechanisms that will define what you can do. Each class represents a meeting of talent, passion, and training. As your calling, it will color how you perceive your career, how you interact with society, and what role you play in a team of adventurers. A combat specialist is a going to take point in dangerous situations and might see the cosmos through the lens of a soldier. A Technophile could be the parties go-to technology guy, responsible for maintaining their gear, and operating some of their high-tech toys. Yet these are only suggestions, your backgrounds and alignment axis will help you shape this further. What specialties you select will refine your character from the outline your class provides.

Classes also provide a number of features, such as the Diplomat's ability to calm others, or the Agent's sabotage. These combine with your Specialties - special skills and feats - to create a robust suite of ability for your character. As you gain levels, your class will provide additional features, or one of your features may gain potency. Your class entry will have a compressive description of each feature. Generally, you will add a feature at levels 1, 3, 5, 7, 10, 14, and 20 in a class. Some Abilities, particularly the first or second ability in a class will grow as you add levels in that class.

People change and grow, as they do, so too do their interests and abilities. As you gain levels you may elect to gain levels in an additional number of classes. This is called Multi-Classing. You may multi-class beginning at 2nd level. Selecting an additional class will provide you with several additional abilities, but your Proficiency Bonus and new specialties are always dependent on your total level.

The eleven basic classes are outlined on the table below. Each class features a specific Hit Dice, Primary Ability Scores, Saving throws, and Proficiencies.



CLASS SYNOPSIS

Class Name	Description	Hit Dice	Saving Throws	Proficiencies	Slots
Agent	An Interstellar intelligence and espionage specialist.	d8	Dexterity & Intelligence	Simple Weapons, Hand to Hand, Stealth, and Security	14
Combat Specialist	A highly trained warrior and battlefield tactician.	d10	Strength & Wisdom	Athletics, Light Armor, and Simple Guns	15
Diplomat	A negotiator, mediator, and peacekeeper.	d6	Intelligence & Charisma	Bureaucracy, Insight, and Persuasion	15
Explorer	A scientist and adventurer with a hearty rugged side.	d8	Constitution & Wisdom	Athletics, Simple Guns, Survival, and Wilderness	14
Insurgent	A brutal guerilla combatant and asymmetrical warfare specialist.	d10	Strength & Dexterity	Simple weapons, Hand to Hand, Simple Guns, and Vehicles.	14
Marshal	Commanders and field officers that specializes in boosting moral.	d10	Dexterity & Charisma	Simple Weapons, Light Armor, Persuasion	15
Science Specialist	An academic master of one or many hard sciences.	d6	Intelligence & Wisdom	Computers and Sciences	16
Spacer	An EVA and Zero Gravity specialist trained in space ship systems.	d8	Dexterity & Constitution	Acrobatics, Piloting, and Weapon Systems.	15
Spiritualist	A philosopher, religious figure, or wanderer seeking the truth of the universe.	d8	Constitution & Wisdom	Intuition and Persuasion	16
Tactician	A cunning political operator who specializes in manipulation.	d8	Wisdom & Charisma	Investigation, Perception, and Deception	15
Technophile	An operations specialist, mechanic, and technical wiz.	d6	Intelligence & Constitution	Computers, Engineering, Vehicles and Repair Kit	14

Beyond Paths

You will find that there is no concept of a path or sub-class built into the character classes in Advent Horizon. Some classes may have the option to select from an array of abilities, and other will be broadly generalized. Classes only represent the foundation of your character and their abilities. Rather than select a sub-class you will customize your characters unique abilities through Proficiencies. Core Proficiencies unlock Specialty Proficiencies that allow you to deeply customize your character.

You are in control of your characters abilities and destiny. Whether you want to be a cold blooded assassin or a preacher turned ace pilot, by selecting the right combination of class and proficiencies you can create virtually any character you can imagine.





AGENT

An elegant woman drapes herself over the arm of a nervous gentleman, he is her hostage though none could tell as, smiling and sipping her champagne as she listens for secrets to sell later. Everyone expects eavesdroppers at a party, but she takes advantage of the loose tongues that come from expensive Terran champagne.

The shadowy figure trades his worker's overalls for the casual garb of a traveler. Perfect for shaking off anyone who might have seen him leave the towering government building. The hard drive in his pocket feels like it's burning, and he is careful not to run and attract more attention to himself.

One swift strike knocks the gun out of the soldier's hands and another blow to the skull renders him unconscious. They had mistaken him for a simple vagabond, and it would prove a to be their last.

Espionage operatives and information brokers, Agents might make use of guile and stealth, or they may be master martial artists. Regardless of your methods, as an agent you will make use of a spycraft to distract, disable, and defeat enemies and overcome obstacles.

Level	Prof. Bonus	Class Features	Prof. Slots
1st	+2	Sabotage, Spycrafts	14
2nd	+2		
3rd	+2	Improvised Proficiency, Spycraft	+1
4th	+2	Ability Score Improvement	
5th	+3	Extra Attack	
6th	+3	Ability Score Improvement	+1
7th	+3	Improved Reaction, Spycraft	
8th	+3	Ability Score Improvement	
9th	+4		+1
10th	+4	Evasive Movement, Spycraft	
11th	+4		
12th	+4	Ability Score Improvement	+1
13th	+5		
14th	+5	Mental Fortitude	
15th	+5	Spycraft	+1
16th	+5	Ability Score Improvement	
17th	+6		
18th	+6		+1
19th	+6		
20th	+6	Impossible Mission	

Operatives and Informers

Information and reputation are as dangerous as a plasma cannon in the right hands. The agent specializes in identifying weaknesses and leveraging intelligence. The backbone of an agent's skillset is their spycraft, techniques and tools used to infiltrate, instigate, and undermine the enemy. Some might think of the Agent as an assassin, but that is like calling a laser a flashlight. Agents are trained to kill, but unlike a combat specialist, they are never trained to dehumanize their targets. What makes an agent so dangerous is not any combat skills, it is their ability to get close to people, manipulate them, and then stab them in the back.

In the end, Agents will use whatever is at their disposal to get the job done. Because no matter what that job is, for most of them, that is all that matters. One could argue that an agent is defined by this mission driven attitude. Agents are often experts in a wide range of Skills, from sciences to combat training, depending on their own goals, motivations, and interests.

Galactic Espionage

Agents come from all walks of life in the galaxy, from planetary nobles to corporate spies, these brokers and movers make up the backbone of every intelligence operation, underground syndicate, and corporate zaibatsu in the arc. Becoming an Agent – whether they are a freelancer or a servicemember – takes extensive training, time, and a certain moral flexibility.

Most members of intelligence operations are not true agents, but generally analysts and engineers. Agents are provocateurs, field operatives, and asset accessors who do the dirty work. They undermine their enemies, spread misinformation, and often act with complete legal impunity – or complete disregard for the law.

Most Agents become adventurers following an unsuccessful operation that leads to them getting burned; blacklisted by the organization that trained them. In more rare cases, an agent might be have gone rogue, seeking out their fortune and future in the frontier of the arc.

Agent Characters

Characters in Advent Horizon are a lot more than a card-board cut-out. While you build your Agent, you should consider what type of training and background they had. Were they a super-spy for one of the corporations, or did they serve at the behest of the Magisterium in a more lethal capacity? Did they retire, or were they burned and kicked out? Maybe you were a rogue freelancer from the very start? Because Intelligence is as important as Dexterity to a successful agent, you might find that you want to make an investigator and linguist, rather than a stealth assassin. The choice is yours.

Class Features

As an Agent, you have the following class features.

Hit Points

Hit Dice: 1d8 per Agent level

Hit Points at 1st Level: 8 + your Constitution modifier

Hit Points at Higher Levels: 1d8 (or 5) + your Constitution modifier per Agent level after 1st

Proficiencies

Saving Throw Proficiencies: Dexterity, Intelligence

Proficiencies: Simple Weapons, Hand to Hand, Stealth, and Security tools.

Proficiency Slots: 14

Sabotage

At first level you learn a suite of techniques called Spycraft, which are fueled by your Sabotage Dice, special dice unique to agents.

Spycraft. At first level you learn 2 Spycrafts of your choice, which are detailed below. Spycrafts often interfere with enemies or aid you in subterfuge. You may only use one spycraft per round, regardless of your number of attacks.

You learn one additional spycraft of your choice at Agent levels 3, 7, 10 and 15. Each time you learn a new spycraft, you can also replace one you know with a different one.

Sabotage Dice. You begin with four sabotage dice. These are d6, and are expended each time you use a Spycraft. You recover your Sabotage dice following a short or long rest. At level 10, all your sabotage dice become d8s.

At Agent levels 5, 10, and 15 you gain an additional sabotage dice.

Saving Throws. Many spycrafts require that the target make a saving throw. The saving throw DC to resist your Spycraft is 8 + proficiency bonus + your Dexterity or Intelligence modifier, depending on the specific craft.

Spycrafts

Spycrafts are presented in alphabetical order.

Advantageous Shot. Making a ranged attack against the target, you strike at the vial areas, dealing extra damage. Add a sabotage dice to damage. If you have Advantage on the attack, you add two dice (but only expend one). On a critical hit you add four of your sabotage dice (still only expending one) to damage.

Advantageous Strike. Making a melee attack against the target, you strike at the vial areas, dealing extra damage. Add a sabotage dice to damage. If you have Advantage on the attack, you add two dice (but only expend one). On a critical hit you add four of your sabotage dice (still only expending one) to damage.

Chink in the armor. Using precision, you create an opening in the target's armor. Roll your Sabotage die – the target's armor rank and armor class are reduced by this amount until the end of your next turn unless they succeed a Constitution saving throw.

Cover Identity. You have a carefully cultivated cover identity that you can exploit for a superior reputation. You can expend one of your sabotage dice to assume this cover for an interaction with an NPC. Roll your sabotage die and add it to your reputation checks for this encounter. Beware, any contacts or connections made at this time belong to your cover, not you.

Cripple. On your turn you make a targeted

attack action against the target, throwing them off balance. If the attack hits, expend one of your sabotage dice to lower the target's initiative by a number equal to the sabotage die roll + your Dexterity modifier.

Disable. By attacking a machine or power armor, you can attempt to impair its function. If you successfully make an attack against the target, roll your sabotage die. The target subtracts this number from all attack rolls, unless it makes a Strength saving throw. This penalty lasts until it is repaired.

Disappear. Taking a Disengage action, you can move your full movement speed, and expend your sabotage die, and adding it to your prowl check. If this is greater than an onlooker's passive perception check, you simply vanish.

Disarm Attack. When you hit a creature with a melee attack, you can expend one Sabotage die to attempt to disarm them, forcing the target to drop one item that it's holding of your choice. You add the sabotage die to the attack's damage roll, and the target must make a Strength saving throw. On a failed save, it drops the object you choose. The object lands at its feet.

Divisive Advantage. Using your action to aid another, you can create a superb opening, adding your sabotage dice to your ally's attack roll, in addition to the normal advantage. If the two dice combined are more than 20, the roll is considered a critical 20.

Intercept. When you are attacked in melee, you may use your reaction to roll your sabotage die and add it to your armor rank for that attack.

Passive Interrogation. By leading a subject into a false sense of security, you can force them to divulge secrets and plans they would otherwise never reveal. You can expend your Sabotage die and add it to a Persuasion, Cold Reading or Insight check.

Perfect Lie. You can add one sabotage dice to a seduction, coercion, or deception check. If the check is successful, the target is considered Charmed for a number of minute equal to you Charisma Modifier. If the roll fails, they become hostile towards you.

Precision Attack. When you make a weapon attack roll against a creature, you can expend one superiority die to add it to the roll. You can use this spycraft before or after making the attack roll, but before any effects of the attack are applied.

Sweep. You learn to assess a situation with a glance. This sweep lets you double your proficiency bonus to Perception checks to notice anything within 10 meters. You can use this bonus at the start of an encounter. Anything not concealed can be spotted in a sweep with a

successful check (DC 10). The DC for concealed or less obvious threats is equal to their prowl or concealment check result.

Improvised Proficiency

At 3rd level, you are considered proficient in improvised weapons. Further, you can make do without proper equipment in certain circumstances. You do not have Disadvantage on Intrusion, Bypass, First-Aid, and Repair checks made without proper tools.

Ability Score Improvement

When you reach 4th, 6th, 8th, 12th, 16th, and 18th level, you can increase one ability score of your choice by 2, or you can increase two ability scores of your choice by 1. As normal, you can't increase an ability score above 20 using this feature.

Extra Attack

Beginning at 5th level you can attack twice, instead of once, when you take the attack action on your turn.

Improved Reaction

Beginning at 7th level you have learned to act instantly. You may add your proficiency bonus to all Initiative checks.

Evasive Movement

Once you reach 10th level, when you take the dodge or disengage action, you add your Proficiency Bonus to your Armor Class until the beginning of your next turn.

Mental Fortitude

Beginning at 14th level, your willpower becomes apparent. You gain Proficiency with Wisdom saving throws

Impossible Mission

At 20th level, you become the ultimate spy. If your attack misses a target within range, or if you fail a skill check, you can treat the d20 roll as a natural 20 instead of a fail. Once you use this feature, you can't use it again until you finish a short or long rest.



COMBAT SPECIALIST

A bright-eyed young man examines his rifle carefully. The drop zone is coming up, and it's his first mission with this crew. A dozen others just like him do the same. He hopes they're as nervous, and as excited, as he is. The comms crackle overhead. The drop zone is only ten more minutes ahead.

An old man leans back in his chair, blaster causally pointed at the offending brawler who brought a fight into his space. He doesn't smile, but no one doubts that he's faster on the trigger than any other man in the room. No one moves. Old soldiers get old by being the best at what they do.

A sword flashes from a scabbard, leaving an attacker dead. In less than an instant the woman

with a missing arm dives into a fight, her team at her heels. None of them have as much experience as she does, but they'll learn, and they'll learn fast. If they don't, they'll wash out and she'll find better to replace them.

Whether you are a professional soldier or street tough merc, as a combat specialist you are a warrior to your core. You will make use of unit tactics and a combat specialty to crush your foes and defend your team, be it as a rifle toting badass, or elite pilot. Regardless, Combat specs take the front line.

Level	Prof. Bonus	Class Features	Prof. Slots
1st	+2	Unit Tactics	15
2nd	+2		
3rd	+2	Combat Specialty	+1
4th	+2	Ability Score Improvement	
5th	+3	Multi-Attack, Tactic	
6th	+3		+1
7th	+3	Brutal Critical	
8th	+3	Ability Score Improvement	
9th	+4		+1
10th	+4	Combat Specialty, Tactic	
11th	+4		
12th	+4	Ability Score Improvement	+1
13th	+5		
14th	+5	Tactical Critical	
15th	+5	Tactic	+1
16th	+5	Ability Score Improvement	
17th	+6		
18th	+6	Ability Score Improvement	+1
19th	+6		
20th	+6	Force Majeure	

Soldiers and Sentinels

Anyone can fight, but it takes special training to not only fight in a real battle but keep calm and operate as part of a team. This separates that Combat Specialist from a rank and file soldier or a backwater guerilla. Combat Specialists are masters of unit tactics, giving them, and their allies, unique advantages as they operate as one organism and work together to overcome their enemies. Make no mistake however, the Combat Specialist is a warrior trained to fight and kill. But by working together or with other fighters they become something far more formidable: they become an army.

Every major power in the galaxy fields a division of special forces. Trained to work together, but also trained to specialize, no two are the same. Some might focus on heavy weapons deployments while another may be an expert in anti-mechanized combat. These unconventional tactics and their deployment make teams of Combat Specialists dangerous in the extreme.

Elite Forces

The path from enlisted man to elite force is a long and difficult one. It takes iron will and dangerous training to reach the level of a Combat Specialist. Taught to fight behind enemy lines as mobile assault forces and expected to achieve military victories with surgical precision, Combat specialists usually take to adventuring for money and freedom.

Acting as soldiers of fortune, Combat Specialists use their tactical training and combat experience to explore hostile worlds, defending researchers and scientists, or simply living as a gun for hire. These mercenaries can command a high price for their dangerous skills and battlefield experience.

Combat Specialist Characters

The Combat Specialist is a trained soldier, having served in the special directive of some military force. This could be a galactic empire such as the Magisterium or the Imperium, or it could be a colonial Corporation or Mercenary Corp. But you should also consider why you left that service. Were you court-marshaled and expelled for a false crime, or did you retire after your term of service? Was your enlistment voluntarily or were you drafted against your will? As you build your character's skills, remember, your most advantageous abilities rely on weapons and your team-mates.

As you consider your most likely military equipment you should think about where this came from – did you pick up this gear as the spoils of war or was it a black-market purchase? Did you steal it when you left the military perhaps?

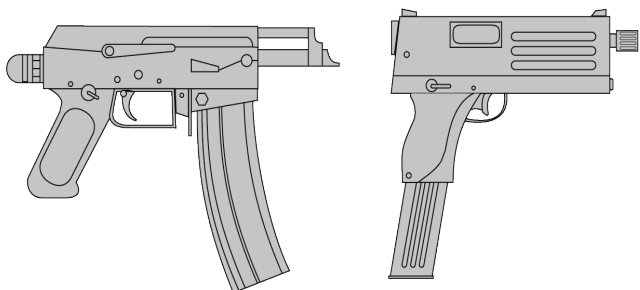

Class Features

As a Combat Specialist, you have the following class features.

Hit Points

Hit Dice: 1d10 per Combat Spec level

Hit Points at 1st Level: 10 + your Constitution modifier

Hit Points at Higher Levels: 1d10 (or 7) + your Constitution modifier per Combat Spec level after 1st

Proficiencies

Saving Throw Proficiencies: Strength, Wisdom
Proficiencies: Athletics, Light Armor, and Simple Guns.

Proficiency Slots: 15

Unit Tactics

Combat Specialists are masters of battlefield tactics. While dangerous alone, you are lethal with a team at your back. Beginning at level 1 you know three tactical maneuvers that support your team, which are described in the section below. Unless stated otherwise, each of these maneuvers require an action on your turn.

You develop a new tactical maneuver at levels 5, 10, and 15. When you learn a new tactic, you may replace one you already know with a different tactic.

Overwatch. You use your action to provide cover for your allies. Until the beginning of your next turn all team members within your weapon's normal range may move without provoking an attack of opportunity.

Command Control. If an ally provides you Advantage on a weapon attack roll through the Aid action, or some other ability, you may make one extra weapon attack against that target as a bonus action.

Mark Target. You can use your action to paint a priority target that you can see within 20 meters. Until the beginning of your next turn, when one of your allies hits the target with a weapon attack, it takes an additional 1d6 damage.

Suppressing Fire. You use your action to lay down covering fire with a ranged weapon in a 10-meter area of your choosing up to 50 meters away. All enemies in this area have Disadvantage on attack rolls and Skill checks until the beginning of your next turn, any creature who attempts to move through or out of this area is subject to an attack of opportunity from you. This consumes at least 6 rounds of ammunition.

Tactical Movement. By moving in a tight

CLASSES

defended formation, at the cost of your action, you and all allies within 2 meters can move up to half your movement as a reaction. This movement does not provoke attacks of opportunity.

Breach and Clear. At the beginning of an encounter, as a bonus action you can sacrifice your turn to detonate a grenade or explosive. This is resolve like a normal grenade attack, however, all enemies in the area of effect are now considered surprised. You must have and expend an explosive to use this maneuver.

Battlefield Signaling. You use your action to signal the position of enemies in view. So long as you can see a target, it is considered in view by all members of your unit until the end of your next turn.

Coordinated Attack. Select a target and make a normal attack. If you hit with this attack, all allies within 20 meters receive Advantage on attack rolls against that target until the beginning of your next turn.

Coordinated Assault. You declare a coordinated assault. If you may make an attack of opportunity against a target as a reaction, all members of the unit within 20 meters may use their reaction to attack the target if they are in range or reach until the end of your next turn.

Combat Specialty

When you reach 3rd level you select a combat specialty. Choose one of the following options.

Armored

You specialize in armored infantry engagement. Your Armor Rank in Tactical and Power Armor is twice your proficiency bonus if you are proficient in the armor you are wearing.

Force Recon

Your specialty is rapid engagement. When you make a weapon attack on your turn, you can make another attack with the same weapon against a different creature that is within 2 meters of the original target and within range of your weapon as your bonus action.

Infantry

When using an automatic firearm with at least five bullets loaded, you may fire a short burst as a single attack action against the target. The character receives a -4 penalty on the attack roll, but deals +4 dice of damage. Firing a burst expends five bullets and can only be done if the weapon has five bullets in it. You may only fire a burst once per turn.

Marksmen

You are an expert Marksmen. You are +2 to attack rolls with ranged weapons. If you have

Advantage on an attack roll with a ranged weapon you add 1 die of damage to the attack.

Mechanized Countermeasures

You specialize in damaging and disabling power armor and robot vehicles. Once per turn your weapon attack against mechanized units such as power armor, mechs and robots can deal an extra 1d8 damage.

CQC

You are an expert in melee and hand you hand combat. When you successfully hit with a melee weapon or unarmed attack, until the beginning of your next turn you can use your reaction to intercept any melee attacks made against you. When you do so, the damage you take from the attack is reduced by 1d10 + your Dexterity modifier + your Combat Spec level. If you attempt to grapple following the use of this ability you have Advantage.

Shock Trooper

Taking point in battle you are a specialist in leading the charge. At the beginning of an encounter you can choose to recklessly attack, if you do so, you gain the initiative for the first turn, regardless of your roll. Until the beginning of your next turn all attacks against you are made with Advantage.

Weapons Specialist

Choose one weapon proficiency you possess. You make all attacks with these weapons at +2. When you roll a 1 or 2 on a damage die for this weapon, you can reroll the die, using the new roll, even if the new roll is a 1 or a 2.

Ability Score Improvement

When you reach 4th, 8th, 12th, 16th, and 18th level, you can increase one ability score of your choice by 2, or you can increase two ability scores of your choice by 1. As normal, you can't increase an ability score above 20 using this feature.

Multi-attack

Beginning at 5th level, you can make two attacks whenever you take the Attack action on your turn. When you reach 11th level in this class the number of attacks you can make increases to three and to four when you reach 20th level in this class.

Brutal Critical

Beginning at 7th level, your weapon attacks score a critical hit on a roll of 19 or 20. When you score a critical hit, you add one additional damage dice of the appropriate type.

Secondary Combat Specialty

Once you reach 10th level as a Combat Specialist you are able to select an additional Combat Specialty.

Tactical Critical

At 14th level when you provide advantage to an ally, either through the Aid action or through a Tactical Maneuver which gives the ally Advantage on an attack roll, they score a critical hit on a 19 or 20.

Force Majeure

Once you reach level 20 fighting together makes you unstoppable. When an ally gives you advantage on an attack through the Aid action, flanking, or another means your weapon attacks are automatically considered critical hits. Additionally, anytime you score a critical hit with a weapon attack the target must make a Constitution saving throw (DC 8 + your Dexterity or Strength modifier + your proficiency bonus). On a failed save, double the damage of your critical hit against the creature.



DIPLOMAT

The peacekeeper stepped into the room to a feeling of expectation. No one was happy with the situation, and an outside perspective was clearly, desperately, needed. That outside perspective was, in this case, not even human.

They had not come in peace. With a glance the seasoned diplomat had sized up the leadership of this pirate armada and found them wanting. With a few platitudes and hollow complements, they had completely dropped their guard. The fools never saw the missiles coming.

An elegant woman passed through the room, resting a hand on an arm here, or greeting someone there. Smiles followed in her wake. Every step and word were perfectly polished, even as she paused to speak with a different group for a few moments and moved on.

With the ability to bring people to the table, to help people understand and accept each other, the diplomat can be an envoy of peace in the galaxy. Or they can be one of the most dangerous weapons in a team's arsenal. Regardless of how, the Diplomat will use their ability to create accords to prevent violence to their allies.

Level	Prof. Bonus	Class Features	Prof. Slots
1st	+2	Accord	15
2nd	+2		
3rd	+2	Enemies to Allies	+1
4th	+2	Accord 2/d, Ability Score Improvement	
5th	+3	Know the Enemy	
6th	+3	Ability Score Improvement	+1
7th	+3	Access	
8th	+3	Ability Score Improvement	
9th	+4		+1
10th	+4	Ability Score Improvement Privilege	
11th	+4		
12th	+4	Ability Score Improvement	+1
13th	+5		
14th	+5	Power	
15th	+5		+1
16th	+5	Ability Score Improvement	
17th	+6	Accord 3/d	
18th	+6	Ability Score Improvement	+1
19th	+6		
20th	+6	Lasting Accord	

The Essence of Peace

The galaxy is rife with conflict and danger, yet it need not be. The known races are all so similar that setting aside our differences should be simple, yet it is not. Those that seek to bridge these divides and build meaningful accords in the galaxy do so at considerable risk. Diplomats must be masters at reading people, become calm and collected even in the face of grave danger, and eventually learn to leverage favors and broker in compromise.

Yet when it comes to the adventuring sort, Diplomats act as the first contact specialist, the deal maker, and the face of their team. Diplomats strength is in their words. Each is chosen carefully, and each can have a lasting impact. Their words are, almost always of peace, and this is what they will strive for, even among a party of the most blood thirsty mercenaries.

Galactic Ambassadors

While tens of thousands are employed by the governments, corporations, and political forces as ambassadors and diplomatic envoys, true diplomats, those with the wherewithal to speak and build a meaningful accord are surprisingly rare. When one appears, their impact on the galactic political climate gets noticed. Those that take up wondering and adventure can never lead an ordinary life. The Arc is rife with conflict, so a trail of chaos can go unnoticed, but a trail of peace, of harmony? That gets attention.

It is usually disillusionment in the establishment which drives Diplomats into a life of adventure. Joining adventuring teams is usually a means for them to see the galaxy and make things better one small victory at a time. Moreover, not every diplomat is a benevolent soul. Some are selfish and cruel and manipulate people into situations where their guard is down so that they can be taken advantage of.

Diplomat Characters

As you create your Diplomat consider who and why they have taken to adventure. For the diplomat the background Event is probably the most crucial aspect, after all they could have done almost anything before becoming a diplomat. Were you a peacekeeper before you became an adventurer, or did you only really become capable of meaningful accords after some traumatic encounter?

Diplomats have the potential to have many skills unrelated to their class abilities which makes them a versatile class. You should consider that while your charisma and wisdom are essential you could have a secondary role you fill through your proficiencies, such as support or even as a medic.

Class Features

As a Diplomat, you have the following class features.

Hit Points

Hit Dice: 1 d6 per Diplomat level

Hit Points at 1st Level: 6 + your Constitution modifier

Hit Points at Higher Levels: 1 d6 (or 4) + your Constitution modifier per Diplomat level after 1st

Proficiencies

Saving Throw Proficiencies: Intelligence, Charisma

Proficiencies: Bureaucracy, Insight, and Persuasion.

Proficiency Slots: 15

Accord

As an action you can engage with every creature who can hear and understand you within 20 meters. Your peaceful words and calm demeanor foster a sense of trust and peace. Until the beginning of your next turn, any creature who wishes to make an attack or use a harmful ability must first make a Wisdom saving throw with a DC of 8 + your proficiency bonus + Reputation modifier + Charisma modifier. On a failed save, the creature must choose a new action, or leave the area. The effect ends immediately if you or any of your perceived allies make an attack or use a hostile ability, or if any of the audience take damage. The accord can be maintained as long as you continue to use your turn to engage with the audience.

While your party is immune to this effect, you are not, and may not take attacks of opportunity or make offensive reactions while the accord is in effect. Targets of attack by your allies are considered surprised if they are still under the effect of the accord at the time of attack. Creatures who save and those creatures you or your party have attacked are immune to this effect until they complete a long rest.

You can create an accord once and must complete a short or long rest before you can use this feature again. At 4th level, you may use this ability twice, and three times at 17th level. The GM

is encouraged to make you role play this ability and your speech.

Enemies to Allies

At level 3, you have become so non-threatening you can convince enemies to ignore you. You attempt to win over an intelligent creature who can understand you and is within 10 meters. At the end of your action, it must make a Wisdom saving throw with a DC of 8 + your proficiency bonus + Reputation modifier + Charisma modifier. The target has Advantage if you or your companions are fighting it. If it fails the saving throw, it is charmed by you until it completes a short or long rest or until you or your companions do anything harmful to it. Your new ally will see you as a friendly and potential ally but will not instantly become hostile to your enemies or its former allies; rather it just sees no reason to attack you.

Ability Score Improvement

When you reach 4th, 6th, 8th, 10th, 12th, 16th, and 18th level, you can increase one ability score of your choice by 2, or you can increase two ability scores of your choice by 1. As normal, you can't increase an ability score above 20 using this feature.

Know the Enemy

Beginning at 5th level, if you spend at least 1 minute observing or interacting with another creature outside combat, you can learn certain information about its capabilities compared to your own. The GM tells you if the creature is your equal, superior, or inferior in regard to two of the following characteristics of your choice:

- Intelligence score
- Wisdom score
- Charisma score
- Number of Charisma Skills
- Presences of Genetic or Cybernetic Augmentation
- Current hit points
- Total class levels (if any)
- Diplomat class levels (if any)

Access

When you reach 7th level you may select one class of Restricted goods, you are able to purchase these good without the appropriate contact through your existing contacts. If you select a class of restricted goods already provided by your contacts or connections, you

purchase these goods at -2 to the item's Credit modifier. This Access is granted you in good faith, with the assumption you mean well, so buying enough illegal weapons to arm a small militia might still raise some eyebrows.

Privilege

At 10th level your reputation as a mediator and peacekeeper proceeds you. Add your Reputation modifier to your Armor class, as people are hesitant to hurt you. Resting on your privilege, you may add your reputation modifier to Persuasion, Command and Deception Skill Checks.

Power

Starting at 14th level your accord affords you some measure of authority. While your accord is in effect, you may use your bonus action to suggest actions to one creature of your choosing who is affected by your accord. The creature must make a charisma saving throw DC of 8 + your proficiency bonus + Reputation modifier + Charisma modifier. Suggestions must be actions the creature can take, and do not directly conflict with their nature or are self-destructive, nor can they be hostile.

You could suggest that they put down their weapons, sit and speak their mind, turn off a ship, or give you an item they are holding. You could not suggest that they attack their allies, or themselves, but could suggest they tell their allies to stop attacking, for example.

Lasting Accord

Once you achieve 20th level as a Diplomat, you can foster meaningful peace. If you can maintain an Accord for 5 full rounds, all participants will remain under the effect for a number of days equal to your Wisdom modifier. You can forge a lasting accord once, and recover the ability following a long rest.



CLASSES



EXPLORER

It was that one big score. The score that every prospector hoped for. His little claim was loaded with valuable minerals. Of course, now he would have to hide it, defend it, or both. But none of that mattered as the young man turned in a circle to admire his incredible find.

Charting the asteroid belt was difficult, but the old woman just couldn't get enough of it. The thrill of knowing that no human had ever been there before kept her going, even long after she should have retired and left the game to the younger generation.

The maps were wrong. For anyone else, that might have been frightening, but for them, it was exciting. No one knew what was actually out here; even the ancient Thothid. Their tentacles wriggled, the thrill of exploration was completely irresistible. It was an opportunity to put their name on the map, and to discover things unseen by any other.

Fearless prospector, rugged navigator, mystery-hungry adventurer, regardless of all else, explorers are always on the edge of the unknown. The Arc accounts for less than a quarter of the milky way, and that means a lot of galaxy to explore.

Level	Prof. Bonus	Class Features	Prof. Slots
1st	+2	Into the Frontier	14
2nd	+2		
3rd	+2	Uncanny Perception	+1
4th	+2	Ability Score Improvement	
5th	+3	Environmental Awareness	
6th	+3	Ability Score Improvement	+1
7th	+3	Extra Attack	
8th	+3	Ability Score Improvement	
9th	+4		+1
10th	+4	Ability Score Improvement Evasive	
11th	+4		
12th	+4	Ability Score Improvement	+1
13th	+5		
14th	+5	Into the Unknown	
15th	+5		+1
16th	+5	Ability Score Improvement	
17th	+6		
18th	+6	Ability Score Improvement	+1
19th	+6		
20th	+6	The Final Frontier	

Adapt and Discover

Explorers are uniquely capable of adapting to the unknown and adverse conditions. They employ their knowledge of survival tactics and their will to survive combined with the lure of the unknown to overcome. Above the Explorer craves new worlds and adventure.

What drives the explorer forward is the need to see what has never been seen before. Their abilities allow them to lead their team into unknown situations with confidence and survive even the most hostile world.

Edge of the Unknown

The human colonists who set out to worlds unknown in the past eon were by all rights explorers, and every year millions of prospectors set out to the edges of the Arc in search of new wonders and new worlds. But the true explorer don't just stop when they find the edge of the unknown, for they most go beyond, go further.

And so, those who are possessed by the wonder of the unknown set out to push that frontier back. They come from all walks of life and backgrounds from scientists to soldiers.

Class Characters

When you are creating your explorer the most important question is what they hope to find out in the unknown. Are they searching for a lost civilization? Are they hunting a human colony ship lost in the void? Maybe they are looking for the origin of the Protogens? No matter the reason, remember that as an explorer you are always looking to the unknown with anticipation, not anxiety.

How you get around and what you travel with are probably major considerations for explorer characters. Unlike most characters who may have a home on a station or planet, as an explorer your home is probably aboard a ship, maybe even one you own.

Class Features

As an Explorer, you have the following class features.

Hit Points

Hit Dice: 1d8 per explorer level

Hit Points at 1st Level: 8 + your Constitution modifier

Hit Points at Higher Levels: 1d8 (or 5) + your Constitution modifier per explorer level after 1st

Proficiencies

Saving Throw Proficiencies: Constitution, Wisdom

Proficiencies: Athletics, Simple Guns, Survival, and Wilderness.

Proficiency Slots: 14

Into the Frontier

As a trailblazer you are accustomed to quickly adapting to new environments. Beginning at 1st level, once you have spent more than 48 hours in an environment, you and your group gain the following benefits:

- Difficult terrain doesn't slow your group's overland travel. It still affects you and your allies in combat.
- Your group can't become accidentally lost so long as you are leading the way. Intentional acts by hostile forces might cause you to lose your bearing, however.
- You remain alert to danger, even while using skills or engaging in other activities. You may always make a perception skill check to detect surprise attacks, ambushes, and danger while you are traveling.
- In the wilds or wilderness, you and your allies automatically recover 1 hit dice of hit points

following a short rest, these hit dice are not spent.

Your experience and adventures also provide you an insight into alien technology and environment. You ignore the penalty for using alien weapons and using skills like find food and water in a foreign environment.

Once you have become accustomed to an environment, if you enter a new environment, it takes two days for you to regain these bonuses.

Uncanny Perception

Beginning at level 3, any time you are called upon to make a perception skill check, you have advantage on that check if you are accustomed to the environment. Beginning at 9th level you add twice your proficiency bonus to perception checks, if you are proficient in that skill.

Ability Score Improvement

When you reach 4th, 6th, 8th, 10th, 12th, 16th, and 18th level, you can increase one ability score of your choice by 2, or you can increase two ability scores of your choice by 1. As normal, you can't increase an ability score above 20 using this feature.

Environmental Awareness

Starting at 5th level you develop an almost preternatural sense of changing weather and dangerous conditions. In an environment you are accustomed, you become aware of dangerous natural phenomena no less than one hour before they occur, including dangerous weather patterns, earthquakes, volcanos, and more unusual events such as plasma storms solar bombardments, meteor showers, etc.

You will even become aware of potentially cataclysmic events, although in the case of a planetary disaster you simply have a vague feeling of unease and danger.

Extra Attack

Beginning at 7th level you can attack twice, instead of once, when you take the attack action on your turn.

Evasive

Once you reach level 10 you develop a knack for getting out of harm's way. You become proficient with Dexterity Saving throws. When you are subject to an attack that calls for a Dexterity saving throw for half damage, if you save successfully you instead take no damage. If you should Fail, you take only half damage.

Into the Unknown

Beginning at level 14 you can become accustomed to a new environment after completing a long rest. In an environment you are accustomed to, your movement speed is increased by 2 meters.

Additionally, when you are the subject of an attack and you can see the attacker, you may use your reaction to make a Dexterity Saving Throw, with a DC equal to the opponent's attack roll. If you save successfully, you suffer half damage from the attack.

The Final Frontier

What holds more promise than the unknown? At level 20 you have become a fearless adventurer.

- You have Advantage on any saving throw to resist fear or intimidation and are immune to anxiety.
- If you roll a 1 on a death saving throw, you may reroll once, and must keep the second roll, even if it is a 1.



INSURGENT

The woman shoved her friends behind her and yanked out the pin on her homemade explosive before she lobbed it over the barricade with the kind of accuracy that came with practice. As soon as it was in the air, another was pressed into her hand, and she took aim again, looking for the best place to cause a big, showy distraction.

The former slave kept his head down and tried not to attract attention. He had a slip of paper clenched in his fist, directions to the next step in the underground railroad to freedom. Guards were everywhere, but running would only make him more obvious.

The gunslinger scrubbed grit out of his favorite gun and watched the rest of the crew go about their business. They didn't like him much, but that was fine. His job was to keep them alive. For now, anyway. If someone offered him more money than this team was, that could change.

The insurgent is a fighter, and regardless of why he fights - for freedom, for justice, or for money - he fights against the odds. The insurgent will make use of tactics and weapons to get the job done. Unlike the combat specialist who fights in units and is improved by their comrades, the insurgent fights alone, and often to brutal effect.

Level	Prof. Bonus	Class Features	Prof. Slots
1st	+2	Brutal Strategy	14
2nd	+2		
3rd	+2	Ride or Die	+1
4th	+2	Ability Score Improvement	
5th	+3	Multi-Attack	
6th	+3	Ability Score Improvement	+1
7th	+3	Merciless	
8th	+3	Ability Score Improvement	
9th	+4		+1
10th	+4	Brutal Critical	
11th	+4		
12th	+4	Ability Score Improvement	+1
13th	+5		
14th	+5	Improved Critical	
15th	+5		+1
16th	+5	Ability Score Improvement	
17th	+6		
18th	+6	Ability Score Improvement	+1
19th	+6		
20th	+6	Against an Armada	

Fighting Dirty

Specializing in asymmetric warfare means that the insurgent makes a point of fighting superior military forces and winning. Their combat abilities assume that they are at a tactical disadvantage in combat fighting a superior force. And the insurgent wouldn't have it any other way, after all there is a reason they are fighting.

Insurgent rarely join the fight because they had a happy life and good schooling. Most come from a background where they were subjected to the oppression, tyranny, and slavery. Insurgents develop their skillsets as a means of fighting back. Many learn the basics of engineering and tooling to create improvised weapons, of hacking to access dangerous information, and demolitions to cripple infrastructure.

Place in the Galaxy

It could be said that you don't choose to become an insurgent, you live long enough fighting to become one. And maybe that is the hardest lesson one has to learn to go from untrained rebel and real insurgent. Live, live through bloody one-sides battles. Live through oppression and hardship. Live while you lose allies, friends, and family.

When an insurgent takes up adventure it usually means the battle was won, or lost. When you survive fighting so long for a cause, and there is nothing left to fight for, it takes a unique and terrible tole. Some insurgents take to adventuring to flee the horrors of their past. Some are trapped in an awful moment that can never escape.

Insurgent Characters

Defined by the will to fight, when creating your insurgent, you should focus on the cause or reason that you became a fighter. Were you from a Xhu occupied world, or are you a colonist fighting against the Imperium? Maybe you were from a corporate colony that suffered under the rule of bureaucrats or a zaibatsu?

Your Insurgent could be a veteran of their crusade, or they could be the result of a war for independence won. Something to consider with your insurgent is the consequences of their war; are they now wealthy from spoils, are they locked into a cruel corporate debt. Choosing a criminal background could mean you character is wanted by the victors in a rebellion lost.

Class Features

As an Insurgent, you have the following class features.

Hit Points

Hit Dice: 1d10 per Insurgent level

Hit Points at 1st Level: 10 + your Constitution modifier

Hit Points at Higher Levels: 1d10 (or 8) + your Constitution modifier per Insurgent level after 1st

Proficiencies

Saving Throw Proficiencies: Strength, Dexterity

Proficiencies: Simple weapons, Hand to Hand, Simple Guns, and Vehicles.

Proficiency Slots: 14

Brutal Strategy

- You specialize in fighting dirty, but effectively. Your training focuses on winning against the odds. At level 1 you gain the following benefits.
- When you make an attack on an opponent and you have Advantage on your attack roll, you will score a critical hit on a natural 19 or 20.
- When you score a critical hit against a target, they must make a successful Wisdom saving throw (DC = 8 + your Constitution Modifier + Proficiency Bonus) or become frightened until the end of your next turn.
- When you score a critical hit against an unaware target, you add one additional dice of damage.
- When you provoke a saving throw with an area of effect weapon or explosive, enemies caught in the area who roll a 1 on their saving throw will suffer double damage.

Ride or Die

Fighting against superior forces requires a ride or die mentality. Beginning at level 3, if you become frightened or provoke an attack of opportunity against you, on your turn you may use your bonus action to turn your fear into mindless rage and unleash a wild attack upon the opponent that frightened you or whom used their opportunity attack.

Until the end of your next turn you gain no bonus to Armor Class from Dexterity but have Advantage on all attack rolls against your target and their allies.

Ability Score Improvement

When you reach 4th, 6th, 8th, 12th, 16th, and 18th level, you can increase one ability score of your choice by 2, or you can increase two ability scores of your choice by 1. As normal, you can't increase an ability score above 20 using this feature.

Multi-Attack

Beginning at 5th level, you can make two attacks whenever you take the Attack action on your turn. When you reach 15th level in this class the number of attacks you can make on your turn increases to three.

Merciless

At 7th level, when you are provided an attack of opportunity, you may make two attack actions, instead of one. The saving throw against traps or explosives you set is increased by your Proficiency Bonus.

Brutal Critical

Once you have reached 10th level, you roll one additional weapon damage die when determining the extra damage for a critical hit. At 15th level this increases to two additional dice, and at 20th level three additional dice.

Improved Critical

At level 14 you are an extremely dangerous opponent. You will now score a critical hit on a 19 or 20, if you have advantage on your attack roll, you will score a critical hit on an 18 through 20.

Against an Armada

Beginning at 20th level, when you and your allies are outnumbered by at least two to one in an encounter you gain the following bonuses:

- You cannot be flanked
- When you provoke an attack of opportunity, any allies within 10 meters may use their reaction to move without provoking an attack of opportunity.
- Each time you or an ally who can see and hear you scores a critical hit, all allies who can see and hear you can recover 2 hit points.
- If one of your allies who you can see or hear is reduced to 0 hit points, you gain a +2 to attack and +4 to damage until the end of the encounter.

You may gain the benefits of this advantage once per long rest.



MARSHAL

The commander surveyed the battle-data on the holo-screens and ran the numbers in her head again. The odds were bad, but the odds had been bad before and they made it this far. A few decisive commands entered on the display and the battle shifted. If she wavered, the crew would lose heart, then their already-bad chances would get considerably worse.

"On me!" the commando shouted as he vaulted out of the trench, bullets and beams screamed all around as his team followed him up and into the firefight. An explosion behind them urged them forward toward the enemy lines.

A noble by birth, the man had a commanding aura that bolstered up anyone who agreed with him and daunted anyone who didn't. He was an army in his own person, and his very presence boosted the moral of everyone in the room. Saber in hand he raised the blade high, signaling the fleet to engage.

Whether they are a field commander, squad leader, or stationed aristocrat, the marshal uses their ability to command and direct to lead their teams in conflict. Marshals are a force multiply in the party. While most are capable fighters, they augment the combat abilities of their team.

Level	Prof. Bonus	Class Features	Prof. Slots
1st	+2	Command Action	15
2nd	+2		
3rd	+2	Battle Commands	+1
4th	+2	Ability Score Improvement	
5th	+3	Extra Attack	
6th	+3		+1
7th	+3	Demoralize	
8th	+3	Ability Score Improvement	
9th	+4		+1
10th	+4	Rallying Call	
11th	+4		
12th	+4	Ability Score Improvement	+1
13th	+5		
14th	+5	No Man Behind	
15th	+5		+1
16th	+5	Ability Score Improvement	
17th	+6		
18th	+6	Ability Score Improvement	+1
19th	+6		
20th	+6	With you into Hell	

Officers and Generals

Marshals are leaders and commanders who augment the abilities of their team mates. With the use of the command actions that can give their allies bonus, additional actions, the Marshal becomes the center of a team.

With their superior leadership, most Marshals make the best of what they have. While a Tactician may move people like pieces on a game board, the Marshal stands shoulder to shoulder with those they lead, often choosing to save their men over achieve their strategic goals.

Place in the Galaxy

The galaxy is suffused with officers, generals, nobles, and commanders. Most thrust into positions of leadership are ineffectual, though a few do rise to rally those under them. Becoming a true leader, one that can inspire and drive, command and impress will, takes a unique kind of training and practice. Most Marshals are raised to be leaders from a young age, or are the elite students of private military academies, though not all.

Marshals pushed into a life of adventure usually become the field commanders of their

party, perhaps they don't want to make the big decisions, and rarely do they have the head for long term strategy, but in the heat of the moment they are the one people turn to call the shots.

Marshal Characters

Like the combat specialist, marshals tend to have backgrounds that represent some sort of military training. Were you educated at a prestigious Military Academy? Perhaps you served as a soldier or in Law Enforcement. These are just a few examples, but this kind of leadership ability is as much a trained skill as it is a natural aptitude.

Compared to other characters, the Marshal is best in a team, and as such they will probably find a hard time fighting alone. When you are creating your marshal, you should keep this in mind, and select abilities that either augment their support role, or attempt to compensate.

Class Features

As a marshal, you have the following class features.

Hit Points

Hit Dice: 1d10 per marshal level

Hit Points at 1st Level: 10 + your Constitution modifier

Hit Points at Higher Levels: 1d10 (or 8) + your Constitution modifier per marshal level after 1st

Proficiencies

Saving Throw Proficiencies: Dexterity, Charisma

Proficiencies: Simple Weapons, Light Armor, Persuasion.

Proficiency Slots: 15

Command Action

At first level, when you give a command to an ally they are filled with a sense of purpose and direction. To use this feature, you must use your bonus action to command one target who can hear you. That creature gains one command action die, a d6.

Within the next 10 minutes, when the creature attempts to enact your command, it can roll the die and add the number rolled to one skill check, attack roll, or saving throw it makes. The creature can only use this die on the action directed by you. Once the Command Action die is rolled, it is used up, and can only have one command action die at a time.

You can use Command Action a number of times equal to 1+ your Charisma modifier (a minimum of once). You regain any expended uses when you finish a long rest.

Your Command action die becomes a d8 at 5th level, a d10 at 10th level, and a d12 at 15th level.

Battle Commands

Beginning at 3rd level you learn to give your allies tactical commands in the heat of the action. Select two of the following Battle Commands, and one more at levels 7 and 14. Each battle command consumes one use of your Superior Command Action feature.

Assault Reaction. If you have the chance to make an opportunity attack as your reaction, you may use one of your Command actions as a bonus action to give this command. You and up to five of your allies who can hear you may use your reaction to attack the target that has provoked the Attack of Opportunity.

Charge. You command an ally to charge the enemy, making a melee attack after taking a full movement. If the ally you command can make this attack before the beginning of your next turn, they may add your command action die to the damage on their melee attack.

Coordinate Assault. Choose one ally who can hear you. You command an attack on a target you can see, and your ally can use their reaction to immediately take the Attack action. If the target is out of range of your ally the action is wasted.

Designate Target. On your turn you call out a target you must be able to see and who does not have cover. Until the beginning of your next turn, your allies add your Command Action die to attack rolls against that target.

Force Movement. On your turn you may use or action to command movement. Choose a number of allies who can hear you within 20 meters up to your Charisma modifier. Using their reaction, each ally can move their full speed, toward an objective you set.

Marshal Shatter. You command one of your comrades to make an attack which creates an opportunity, if the target is struck before the beginning of your next turn, if you use your action to attack that target, you add your Command Action dice to damage on the first attack you make against that target.

Valorous Command. Commanding a wounded ally, you roll your command action die. The ally, who must be able to hear you gains temporary hit points equal to your command action die roll.

Virtuous Command. You command an ally to provide aid to another. So long as the aid takes place before the beginning of your next turn, the

action to which the aid is applied may add your command action die, as well as your charisma modifier, to the roll.

Ability Score Improvement

When you reach 4th, 8th, 12th, 16th, and 18th level, you can increase one ability score of your choice by 2, or you can increase two ability scores of your choice by 1. As normal, you can't increase an ability score above 20 using this feature.

Extra Attack

Beginning at 5th level you can attack twice, instead of once, when you take the attack action on your turn.

Demoralize

Starting at 7th level, using your action, you can attempt to demoralize your enemies. All enemies who can hear and understand you must make an intelligence saving throw DC 8 + your Proficiency bonus + your Reputation modifier. Those that fail the save are demoralized. Any time with in the next ten minutes, you can choose to activate this effect on your reaction, reducing the affected target's roll by your Command Action die. This uses one of your Command Actions for the day.

Rallying Call

Once you reach 10th level you can rally your comrades and allies. As your action you can boost all allies who can hear and see you. Your presence and moral will overcome all anxiety, charmed, frightened, and stunned conditions on your allies. You can use this feature as an action on your turn once per round.

No Man Behind

Beginning at 14th level, you can use your powers of command and presence to invigorate fallen allies. When one of your comrades has fallen and you attempt to stabilize them, if you succeed, your ally will gain 3d6 temporary hit points and regain consciousness with 1 hit point.

With you into Hell

You are recognized as a superior commander and leader. Once you have reached level twenty, your presence instills your allies with confidence and vigor. All allies who can see and hear you on the beginning of their turn are immune to any attempt to instill fear, demoralize, or intimidate them.



SCIENCE SPECIALIST

The white uniformed doctor continued to curse under her breath as bionic armatures and deft hands worked to suture the bleeding soldier. The messy confrontation left half the crew wounded, and she had a long day ahead of her. One step at a time. The first step was to save this man. There would be plenty more after him.

From the bridge of the ship a man wearing a lab coat over a mercenary's wear observed the pulsing nebula breathlessly. Such a thing has never been seen by human eyes and would likely never be seen again. When asked why he abandoned a prestigious professorship to serve aboard the Ghostwave, this would be his answer.

Field study was always complicated, but the young student took on the challenge eagerly. After all, opportunities like this didn't come along very often. They were discovering new substances every day, and this one might revolutionize energy efficiency as people knew it. The only trouble being the ruins were on a planet with some hostile indigenous life. At least she was getting better with a pistol.

Whether they are a doctor, explorer, or field researcher, the science specialist is, well, a specialist in the sciences. Throughout the Arc science specialists are well respected and well sought after, in the vastness of space a skilled doctor, physicist, and chemist is worth their weight in antimatter. The Scientists make use of their extensive knowledge to solve problems, heal, or build new equipment.

Level	Prof. Bonus	Class Features	Prof. Slots
1st	+2	Scientific Expertise, Scientific Problem Solving	16
2nd	+2		
3rd	+2	Intelligent Defense	+1
4th	+2	Ability Score Improvement	
5th	+3	Scientific Accolade	
6th	+3		+1
7th	+3	Quick Thinking	
8th	+3	Ability Score Improvement	
9th	+4		+1
10th	+4	Secondary Expertise	
11th	+4		
12th	+4	Ability Score Improvement	+1
13th	+5		
14th	+5	Intelligent Offence	
15th	+5		+1
16th	+5	Ability Score Improvement	
17th	+6		
18th	+6	Ability Score Improvement	+1
19th	+6		
20th	+6	Scientific Master	

The Power of Science

Conducting research and using data to solve problems, Scientists range from purely academic researchers to experimental specialists that focus on the development of prototype technology. Armed with their knowledge of how the universe works and the ability to employ the scientific method to problem solving they can find novel solutions to dangers that would leave others stumped.

Dedicating one's life to the sciences requires an open mind and the ability to suspend your preconceptions in favor of discovering something that fundamentally changes your view of the world. This is something people often forget, science is about questioning the nature of the assumed, not answering questions. Occasionally a testable theory will arrive from those questions, and we can learn something to exploit as new technology or techniques.

Beyond an Ivory Tower

While researchers and scientists exist throughout the galaxy, the Specialist is far more than a dusty book worm, their curiosity and lust for knowledge will always lead them to lives far beyond normal. The frontier of the galaxy is where the frontiers of science are pushed, and so these intrepid souls set out to discover what lies at the edge of the unknown. It is in pushing those boundaries that real discoveries are made.

Most Science specialists take up a life of adventure to further research, but not always. On rare occasion a brilliant mind is forced to lead such an unconventional life owing to more extreme circumstances. It is not unheard of for science specialists to become adventurers after they make a discovery with troubling implication.

Science Specialist Characters

Education plays a huge role in the origin of your scientist. Were you part of a prestigious college, or did you rise to acclaim from a humble beginning? Intelligence is key for the science specialist, many will develop a diverse set of skills to help them in their work. While you create your character consider this, as well as your area of expertise.

One final thought to consider is that field work in any science requires resources to fund. Exploring the outer reaches of matter physics requires costly sensors and exotic high energy events, developing cutting edge A.I. means computers and prototypes that can cost a fortune, studying exotic ancient ruin means costly trips to unknown and hostile worlds. In short, science requires capitol, and adventure is a great way to get it.

Class Features

As a Science Specialist, you have the following class features.

Hit Points

Hit Dice: 1d6 per Science Specialist level

Hit Points at 1st Level: 6 + your Constitution modifier

Hit Points at Higher Levels: 1d6 (or 4) + your Constitution modifier per Science Specialist level after 1st

Proficiencies

Saving Throw Proficiencies: Intelligence, Wisdom

Proficiencies: Computers and Sciences.

Proficiency Slots: 16

Scientific Expertise

Beginning at 1st level, you have a scientific specialty, which represents your primary area of scientific expertise. Choose one of the following which represents your scientific expertise.

Anthropological Science. You're an expert in the field of ancient history and archeology. You gain proficiency in the history skill.

Computer Science. You are at the forefront of computer research and AI development. You have the Programming specialty.

Epigenetics. An expert in biology, you are a renowned biologist and geneticist. You have the Genetics specialty.

Chemist. You're a chemistry expert and receive either the Chemistry or Organic Chemistry specialty.

Medical Doctor. You are an expert in the art of medicine and healing. You gain proficiency in Medicine.

Scientific Problem Solving

Beginning at level 1, when you would be at Disadvantage on a skill check due to circumstances such as working with alien technology, lack of proficiency with the tools available, or missing information, you may instead roll normally so long as you have one full hour to address the problem with the scientific method. As a side benefit, this ability allows you to improvise many common tools and equipment needed to use more advanced aspects of the skills in your scientific specialty with an hour of work.

Intelligent Defense

Once you reach 3rd level you have spent enough time in the field to realize danger when it is clear and present, adding your Intelligence modifier to your AC in combat.

Ability Score Improvement

When you reach 4th, 8th, 12th, 16th, and 18th level, you can increase one ability score of your choice by 2, or you can increase two ability scores of your choice by 1. As normal, you can't increase an ability score above 20 using this feature.

Scientific Accolade

By 5th level you have become quite renown in your field. You receive twice your proficiency bonus when you make checks with your Skill expertise. Beginning at 10th level you receive twice your proficiency bonus with the specialty skills under your scientific expertise.

These accolades usually accompany some minor research publication or breakthrough which will earn you recognition and prestige in your scientific field. While you may not yet be a household name, people of influence and power recognize your expertise, giving you a +2 bonus to your Reputation modifier. Publication also comes with some financial benefits as well, giving you a onetime bonus to your Credit modifier of +2.

Quick thinking

By level 7 you are used to field work, you can react with unique alacrity in danger, and are able to use any skill you have as a bonus action in combat, excluding weapon proficiencies. Your quick thinking means that you may treat a roll of 9 or less as a 10 on any skill check for the skills under your chosen Scientific expertise.

Secondary Expertise

At 10th level you have become a master of a second scientific area. Choose a second scientific expertise.

Intelligent Offence

Once you have reached level 14 you are able to analyze enemies in an instant and identify weaknesses, adding your Intelligence Modifier to attack rolls made with weapons you are proficient in.

Scientific Mastery

At 20th level you become a major name in the scientific community. Anyone with a background in one of your areas of expertise is likely to recognize you. By this point you likely have released a significant research publication or made a significant breakthrough which earned you recognition and prestige in your scientific field. This results in a +2 bonus to your Reputation modifier. Publication also comes with some financial benefits as well, giving you a onetime bonus to your Credit modifier of +3.



SPACER

Ixaxian pilots were usually crazy, but this one took it to a whole new level. Unfortunately, they were also usually the best pilots around. Still, the captain was questioning his own judgement as his pilot chattered excitedly, before plunging their small frigate into the gas giant's thick atmosphere. Half the pirates on their tail spun out wildly, the rest unable to follow an Immelmann turn he didn't even know was possible.

The route was set, but something about the numbers looked funny. Horizon Drive math was tricky, and relied on several assumed constants that, well, were not always constant. The navigator leaned over and examined the math skeptically. His gut told him that some grave eddies from a nearby neutron star were not accounted for, rerunning the calculations he smiled triumphantly. And they said a computer could do it better!

Adrift amid the wreckage, sensors would never be able to detect the single life sign. This was illegal salvage, after all. The scraps of ancient behemoths drifted as testament to an ancient battle. And amid the ruined debris was real treasure. So, from wreck to wreck he drifted collecting the small crystals. Not as valuable as power systems, but more abundant.

CLASSES

What all spacers share, be they pilots or spacewalkers, is a preternatural connection to the void. As if some dormant gene suddenly becomes away in the drift of space. Spacers are unusually adapted for living and working in space. Their natural sense of directionality and orientation make the superb astronauts, pilots, and navigators.

Level	Prof. Bonus	Class Features	Prof. Slots
1st	+2	Born to the Void, Sphere Song	15
2nd	+2		
3rd	+2	Superior Piloting	+1
4th	+2	Ability Score Improvement	
5th	+3	Space Adaptation	
6th	+3		+1
7th	+3	Extra Attack	
8th	+3	Ability Score Improvement	
9th	+4	Sphere Song	+1
10th	+4	Generalist	
11th	+4		
12th	+4	Ability Score Improvement	+1
13th	+5		
14th	+5	Navigator's Instinct	
15th	+5	Sphere Song	+1
16th	+5	Ability Score Improvement	
17th	+6		
18th	+6	Ability Score Improvement	+1
19th	+6		
20th	+6	One with the Void	

Call of the Expanse

Spacers are a generalist who excel in space-based action. Often though, spacers become pilots and operators of starships, due to their natural aptitudes. But this is far from the only role they may play. Some spacers take up the sciences or learn to fight in the depths of space.

For whatever reason, Spacers simply cannot abide living planet-side. Inevitably this drives them into space, into the freedom of the expanse. This means spacers will take any job that will get them off world, which leads to an eclectic range of skills and experiences.

Adrift in the Arc

Millions transverse the starways of the Arc every day. Millions more live and work in space aboard long-haul ships, space stations, and distant outposts. Yet among these millions upon millions few ever become true spacers. It takes some spark, some ancient and unknowable instinct to feel safe and at home adrift in what is literally the least hospitable place to most known life.

Spacers are, by nature, adventurers in the truest sense. The bond they share with the void leads them to live rather extra ordinary lives. Even the most academically inclined spacer has likely gone to extreme lengths to get their way in to the depths of the void. Ever reaching into the ocean of stars, the spacer does not care why, or even for what reason, so long as they get the opportunity to live in the embrace of the cosmos.

Spacer Characters

Becoming a spacer is often about instinct. When you create your spacer consider that in your background. Did you feel the calling of the expanse while in school or where you born in the void and have always been at home there? Are you a fighter, a scoundrel, or a perhaps an intellectual? Whatever you decide, remember that a Spacer is ill at ease in the well of a planet's gravity.

It is believed by some that true spacers are an adaptation to the rigors of space travel, that by some small piece of life emerged among the stars. The adaptations arise after a few generations of space travel some claim, and that it shows evidence of an ancient spacefaring origin to life. Or so some believe.

Class Features

As a Spacer, you have the following class features.

Hit Points

Hit Dice: 1 d8 per Spacer level

Hit Points at 1st Level: 8 + your Constitution modifier

Hit Points at Higher Levels: 1 d8 (or 5) + your Constitution modifier per Spacer level after 1st

Proficiencies

Saving Throw Proficiencies: Dexterity, Constitution

Proficiencies: Acrobatics, Piloting, and Weapon Systems.

Proficiency Slots: 15

Born to the Void

At 1st level, your attunement to the stairways is clear. You are particularly accustomed to life in the void. While in space, either aboard or ship or station you have several unique benefits:

- You do not lose initiative transferring from zero gravity to gravity, or back.
- You can automatically orient in zero gravity and cannot be flanked while in zero gravity.
- While moving aboard a ship or station, you have Advantage with stealth and Acrobatics checks.
- You only use 2/3rd as much oxygen as other characters.

Sphere Song

Beginning at 1st level, you develop two special skills called sphere songs. These adaptations augment your capacity to operate in the void. You select an additional sphere song at levels 9 and 15.

Detect Horizon

As an automatic ability you can detect when a horizon drive is active within 10 kilometers of your location.

Drifting Dodge

In microgravity, you may add your wisdom bonus to your armor class if you are un-armored.

Gravity Aim

While operating in micro-gravity, you use your full turn to concentrate on landing your next ranged attack. On your following turn you gain Advantage on the next attack roll you make when you take a ranged attack action.

Gravity Fall

You may use your reaction when you begin to fall to reduce the damage you suffer from the fall by half.

Gravity Hit

You can use your action to concentrate on your next melee attack. If your next Melee attack hits you may add 1d6 damage to the attack. This becomes 1d8 at 7th level, and at level 14 the bonus damage is 1d10.

Immunization

You become immune to natural disease. Against artificial diseases, such as nano-viruses, you gain advantage on saving throws.

Power Armor Mastery

While wearing power armor and light mechs your maximum DEX bonus is increased by 1. At level 10 this increases to 2. This only applies to active mechanized armors.

Recognize Star System

You have seen much of the galaxy by level 1, and on a successful DC 15 intelligence check you can recognize any major inhabited star system. If you have the Astronavigation skill, you may make an Astronavigation check instead.

Slow Metabolism

You can hold your breath twice as long and normal. During your short and long rests your metabolism slows to a hibernation like crawl. This allows you to reduce the amount of food you need by half.

Superior Piloting

By 3rd level you become attuned to operating and motion in space. You gain advantage on Piloting skills you are proficient in when operating in micro gravity.

Ability Score Improvement

When you reach 4th, 8th, 12th, 16th, and 18th level, you can increase one ability score of your choice by 2, or you can increase two ability scores of your choice by 1. As normal, you can't increase an ability score above 20 using this feature.

Space Adaptation

Beginning at 5th level you become more adept at operating in space. This manifests in several ways:

- You require half as much oxygen as other creatures. You have Advantage to save vs poison gasses.
- You are immune to casual radiation exposure, and gain Resistance to Radiation damage.
- You learn to recognize the spots and lights in your eyes from dangerous radiation sources and cosmic rays.

Extra Attack

Beginning at 7th level you can attack twice, instead of once, when you take the attack action on your turn.

Generalist

At level 10 you have become a generalist and jack of all trades. You may add one-half your proficiency bonus, rounded down, to any Skill check which you are not proficient in.

Navigator's Instinct

Once you achieve level 14 you gain insight into the song of the spheres. While more than

5,000 km from a planet's surface you can pinpoint the nearest star within 35 AU of your current position, as well as other potentially dangerous gravitational anomalies. This manifests as little more as a vague sense of the direction and size for the gravity well. While you are in a familiar star system you can determine your relative position with this ability.

One with the Void

Beginning at 20th level you achieve a kind of union with the void. You gain a zero-gravity movement speed of 2 meters or increase such a speed by 2 meters. You can use this ability in the vacuum of space. This ability has a psionic component, and effects which would neutralize psionics, neutralizes this ability.

SPIRITUALIST

Belief gave stability in a chaotic world. The woman walked through the streets, her feet bare, and her smile kind. She had a bag of bread and cred chips and pressed both into the hands of anyone who needed them. Thanks, and blessings, followed her as she moved through the slums of the city. This simple kindness was causing all sorts of problems for the Corporation though, with food and money the slums were beginning to get angry about the situation.

Angry shouts mingled with the raucous laughs that followed as the gambler as he hurtled himself down the winding road of the settlement, he had taken the table for all they had – twice. Probably a bad idea but it was just getting fun. Turns out the biggest loser was the son of the local gang's boss, seemed they took umbrage with his uncanny luck. A few bullets whistled past his head. Yeah, this was a great night.

Beads of wood and stone adorned his wrist and neck, he sat legs tucked in the traditional positions of the shamans of his home. The Ba'alur met the thugs' gaze evenly, and unfazed. Though unarmed he radiated a dangerous calm and even more dangerous potential. Suddenly the wondering holy-man seemed like a dangerous target.



Level	Prof. Bonus	Class Features	Prof. Slots
1st	+2	Practiced Intuition	16
2nd	+2		
3rd	+2	Uncanny Intuition	+1
4th	+2	Ability Score Improvement	
5th	+3	Akashic Knowledge	
6th	+3		+1
7th	+3	Wise Counsel	
8th	+3	Ability Score Improvement	
9th	+4		+1
10th	+4	Keen Intuition	
11th	+4		
12th	+4	Ability Score Improvement	+1
13th	+5		
14th	+5	Killing Intent	
15th	+5		+1
16th	+5	Ability Score Improvement	
17th	+6		
18th	+6	Ability Score Improvement	+1
19th	+6		
20th	+6	Kismet	

Fate and fortune, luck and intuition, the Spiritualist follows the flow of the universe, often wandering where chance takes them. And fate does really seem to protect the spiritualist however. Their uncanny intuition and natural luck seem to bend the believable.

What the Cosmos Wills

Some choose to believe in some higher power which guides them, others simply that the universe has some goal for them. Rarely a spiritualist simply believes in their own superiority, that they can will through the universe.

The Spiritualist may take any number of roles, their intuitive abilities make them versatile and diverse. Above all the spiritualist will seek to elevate and enlighten their party, ever reaching to redeem the darkest of them and empower the most noble. Often at terrible peril.

Celestial Guideposts

It takes a special kind of will you wander the Arc looking for spiritual and philosophical enlightenment. Some seek out an answer to the question of meaning, others simply look out for their destiny. But, being so well fortune'd, a few spiritualists simply become risktakers and gamblers seeing how far their luck and intuition can take them.

Even so, those that progress to become spiritualists often do so through an iron will, prescient intuition, and unwavering conviction. This often follows some meaningful signpost or awakening that allows the spiritualist to fully lay their insurmountable resolve behind some measure of universal connection.

Spiritualist Characters

What drives your spiritualist? Do you seek some cosmic truth, or are you after enlightenment in the clutches of the infinite? The metaphysical motivations of the Spiritualist are often the most important to them. While some might accuse them of being cowards, a pacifist might hold to that even at the cost of countless thousands of lives, conversely, one who holds to the sanctity of life might not flinch at killing someone to prevent the deaths of thousands.

When creating your spiritualist, consider what they did before embarking on their pilgrimage. Were you a member of the corporate elite that became disillusioned, or maybe you had a life of hardship that enlightened you to the justice of the world.

Class Features

As a Spiritualist, you have the following class features.

Hit Points

Hit Dice: 1d8 per Spiritualist level

Hit Points at 1st Level: 8 + your Constitution modifier

Hit Points at Higher Levels: 1d8 (or 5) + your Constitution modifier per Spiritualist level after 1st

Proficiencies

Saving Throw Proficiencies: Constitution, Wisdom

Proficiencies: Intuition and Persuasion.

Proficiency Slots: 16

Practiced Intuition

You have honed your intuition, letting it guide you. Beginning at 1st level you gain the following benefits:

- You may substitute your Wisdom Modifier for your Intelligence modifier on any Intelligence skill you are proficient in.
- You add your Wisdom Modifier to your Armor Class while you are unarmored.
- You may substitute your Wisdom Modifier in place of your Dexterity Modifier for attacks with ranged weapons.

Uncanny Intuition

At 3rd level you gain 2 + your Wisdom Modifier Intuition Points that you may spend to activate several unique abilities. You recover all your intuition points following a long rest. When you roll a natural 20 on an attack roll, skill check, or saving throw you automatically regain 1 intuition point.

Uncanny Dodge. Spending 1 intuition point, you can take the dodge action as a bonus action on your turn.

Uncanny Empathy. Reaching out with your heart, you spend 1 intuition point to glean the general emotional state of a target creature you can see and hear within 10 meters. This would reveal if they are calm, angry, scared, or anxious. It will also flawlessly reveal if a target is being honest, deflecting, or lying, their general level of power (hit dice) and if they harbor ulterior motives.

Uncanny Faith. Be it faith in a power, a person, or yourself, this conviction allows you to add your Wisdom modifier to the result of an attack roll, skill check, saving throw, or ability check at the cost of 2 intuition points as a reaction.

Uncanny Healing. By tending to the wounds of another on your turn, they recover 1 hit dice of hit points (plus any from Treat injury or medical tech) at the cost of 1 intuition point.

Uncanny Luck. As a reaction, you spend 2 intuition points to succeed on a failed saving throw.

Uncanny Speed. You move with alacrity gained from your intuitive direction. By spending 1 intuition point you may move 2 extra meters on your turn and ignore difficult terrain.

Uncanny Strike. You let intuition guide your attacks to the weakest point. Spend 1 intuition point on your turn when you make a weapon attack which uses your wisdom modifier, this attack ignores armor rank equal to your wisdom modifier.

Ability Score Improvement

When you reach 4th, 8th, 12th, 16th, and 18th level, you can increase one ability score of your choice by 2, or you can increase two ability scores of your choice by 1. As normal, you can't increase an ability score above 20 using this feature.

Akashic Knowledge

Beginning at 5th level you can use your intuition to perform skills you normally would not possess. Select one of the following Akashic Knowledge abilities. At levels 10, 15, and 20 you may select another Akashic knowledge trait.

Akashic Strike. Spending 1 intuition when you make an attack roll you gain advantage on the attack roll.

Akashic Proficiency. By spending 2 intuition points on your turn, you may roll any skill as if you possessed proficiency in that skill. This akashic proficiency is short lived and only lasts for a few rounds at most, so while a quick repair job may be possible, crafting a weapon or gene graft is not.

Defense of Kismet. On your turn you may spend 1 intuition point to add your wisdom modifier to your Armor Class while wearing armor. This bonus lasts until you complete a short or long rest.

Intuitive Action. At the end of your turn you may spend 1 intuition point to make an additional attack action.

Akashic Deflection. You can use your reaction to spend 1 intuition point to deflect the projectile or beam when you are hit by a ranged weapon attack. When you do so, the damage taken from the attack is reduced by 1d10 + your Wisdom

modifier + your spiritualist level.

Akashic Awareness. On your turn you may spend 1 intuition point to immediately become momentarily aware of the presence of any unseen, invisible, hidden, or obscured creatures within 10 meters. You may instead become aware of the specific location and movements of one unseen, invisible, hidden, or obscured creature within 10 meters until the end of your next turn.

Still Mind. On your turn you may use your action to still your mind, spending 1 intuition point and removing one of the following conditions: Anxiety, Charmed, Frightened, Paralyzed, Provoked, Shock, or Stunned.

Wise Counsel

At 7th level you learn the ability to share your insights with others. On your turn you may expend 1 intuition point to remove one of the following conditions from a creature that can see and hear you within 10 meters: Anxiety, Charmed, Frightened, Provoked, or Shock.

When you provide Aid to another character on a skill check, you may spend 1 intuition point to add your Wisdom Modifier to the final roll.

Keen Intuition

Once you are level 10, you find your intuition has sharpened. You gain the following benefits:

- Add you Wisdom to your Armor Class even while in armor.
- You cannot be frightened.
- You add your Wisdom modifier to Death Saving throws.

On your turn, you may spend 1 intuition point to take an additional action, be it to attack, move, dodge, or use an item. You do not gain additional bonus or reactions, this is a standard action, not an extra turn.

Killing Intent

Starting at 14th level, you can sense the will to do you harm. No creature can gain Advantage on attack rolls against you by hiding, attacking at range, or flanking. When a creature declares an attack against you, you become aware of this intent.

Additionally, creatures have Disadvantage in any prowl check against you. This ability has a psionic component, and effects which would neutralize psionics, neutralizes this ability.

Kismet

You've attained a state of intuitive harmony with the universe, and at 20th level you are beyond the reach of other's good luck. It is impossible to score critical hits against you, and you may choose to spend 2 intuition points prior to making an attack roll to automatically score a critical hit on any roll besides a 1.

TACTICIAN

A young politician leans back in his chair, satisfied at a job well done. It took months, years, of work, but he's finally in the position to topple the Corporation's control for good. The best part was that he was the only one who know what happened next. For now.

An aged woman straightens, centuries of family history over her shoulders like an invisible cloak of heritage. Nothing is more important to her than her family name, and there is nothing she will not do to defend it. She slips the pistol back into her dress and surveys the dead delegation. Nothing.



The corporate soldiers had come to the mining colony expecting scattered resistance from untrained roughnecks but encountered an organized defensive strategy. With a small smile the girl in the back leaned in as the corporate representative glumly accepted the rebels' terms. The still had no idea who was pulling the strings. Long live the revolution.

Politicians, provocateurs, and consuls, the Tactician is a master of strategy. You will make use of your ability to make and employ strategic plans to overcome your enemies and enhance your allies. Moving them like chess pieces, you place your plans in motion and watch them unfold.

Level	Prof. Bonus	Class Features	Prof. Slots
1st	+2	Cunning Mind	15
2nd	+2		
3rd	+2	Devious	+1
4th	+2	Ability Score Improvement	
5th	+3	Dangerous Allies	
6th	+3	Ability Score Improvement	+1
7th	+3	Plan of Attack	
8th	+3	Ability Score Improvement	
9th	+4		+1
10th	+4	Improvise Strategy, Ability Score Improvement	
11th	+4		
12th	+4	Ability Score Improvement	+1
13th	+5		
14th	+5	Prescience	
15th	+5		+1
16th	+5	Ability Score Improvement	
17th	+6		
18th	+6	Ability Score Improvement	+1
19th	+6		
20th	+6	The Perfect Plan	

The Masterminds

Wars are won with strategies and businesses are ruled with planning. At the heart of every great moment is some architect and mastermind. Some seek dominion and temporal power, others simply wish to see their allies succeed. And all of it revolves around a plan. This is the essence of the Tactician, the development of masterful strategies that can tip the balance from failure to certain success.

It takes a broad and eclectic background to become a master Tactician, so these strategists can come from every walk of life. What they have in common is a mind that sees relationships and connects dots in a tapestry of causality. As this talent is cultivated, the strategies employed become more devious, more nuanced, and more full proof.

With Cunning and Manipulation

To the Tactician, wits and intelligence are the most valuable weapon. Any sodding stationer can blow holes in someone with a particle beam, but convincing that same sod to shoot up his own team takes real talent. That's why the Tactician is so dangerous, they employ all the weapons at their disposal, be it their allies' or their enemies'.

Make no mistake, Tacticians play to win, and the play for keeps. They will always have a plan, and will have plans within those plans, and all of these will be part of some larger strategy, some goal that could be days or weeks into the future. Yet each act is a deliberate step towards that goal, each act is intentional and accounted for.

Of course, no plan is perfect, and things will go wrong. And that is where the particle beam comes in.

Tactician Characters

These schemers tend to come from the two extremes of society, either rising from the streets as self-made, and often criminal, successes, or as aristocrats and privileged corporate elites born to wield influence. When selecting your education and career keep this in mind. Were you a noble from the heart of the imperium seeking a real challenge and slumming it in the colonies? Or are you a former criminal kingpin eager to leave your life of wrong-doing behind you? Perhaps you are the exception, and trained in military strategy and an academy?

Your mind is your greatest weapon, so remember to select proficiencies and equipment that let you contribute to the team in a more logistical role. After all, it is better to let someone else soak up the bullets.

Class Features

As a Tactician, you have the following class features.

Hit Points

Hit Dice: 1d8 per Tactician level

Hit Points at 1st Level: 8 + your Constitution modifier

Hit Points at Higher Levels: 1d8 (or 5) + your Constitution modifier per Tactician level after 1st

Proficiencies

Saving Throw Proficiencies: Wisdom, Charisma

Proficiencies: Investigation, Perception, and Deception.

Proficiency Slots: 15

Cunning Mind

You are a master of manipulation and strategy. Prior to a dramatic situation, be it combat or a skill contest, the Tactician can develop a winning Strategy. Using this feature requires preparation; you can't use this feature when surprised or otherwise caught off guard. You add a +1 Strategy bonus to you and your allies' skill and attack rolls after 5 minutes of preparation and planning. For each additional 5 minutes of preparation, you add an additional +1 to a maximum of +5 after twenty-five minutes of preparation.

Your strategy bonus can be applied to all skill checks and attack rolls, however reduce the bonus by 1 point (to a minimum of +0) each round, as the evolving situation unravels even the best-laid plans.

At 5th level you can manipulate the situation through your plan to give you Advantage on all rolls with one skill (including weapon proficiencies) until the strategy bonus from your preparation is gone.

When you reach 10th level, when an encounter begins for which you have developed a strategy you can impose Disadvantage on all actions by one target who you must have selected in advance. This penalty lasts until your strategy bonus reaches 0.

Devious

At 3rd level you become nearly impossible to read. You add your Intelligence modifier to the DC of any attempt to size you up, extract information, or detect your lies. If this is a contested skill roll you add your Intelligence Modifier to Seduction, Deception, Manipulation, and Cold Reading skill checks.

Ability Score Improvement

When you reach 4th, 6th, 8th, 10th, 12th, 16th, and 18th level, you can increase one ability score of your choice by 2, or you can increase two ability scores of your choice by 1. As normal, you can't increase an ability score above 20 using this feature.

Dangerous Allies

Beginning at 5th level you learn to turn one character against another. You must spend a full-round action and know the name, rank, or other meaningful designation of the character he or she is attempting to persuade as well as the same of the character toward whom the target's distrust will be directed. The target must be able to hear and understand you.

At the end of the round, your target makes a Wisdom saving throw with a DC of 8 + your proficiency bonus + Charisma modifier. If the target fails the save, his or her attitude toward the other designated character becomes distrustful and potentially hostile. How this plays out is up to the GM, close friends and allies might simply become temporarily disagreeable, whereas mercenaries that are little more than strangers may attack one another. As long as the target continues to fail the Wisdom save, you can continue taking full-round actions to maintain the target's attitude toward a designated character.

A successful save doesn't undo any damage to the target's relationships, but it does render the target immune for until they complete a long rest. This ability is useless against other players and your own Contacts and Connections. The GM is encouraged to have you role-play this ability; what do you say, what mind games do they attempt to play with your target. The more you know about the targets without having a personal relationship, the easier it is to sway them and foster distrust. Especially if you don't have to lie.

Plan of Attack

Once you reach 7th level you become a master of strategic action. If you currently have a strategy bonus you may make one additional action on your turn. This could be an attack, using a skill, or using an item.

Improvise Strategy

Beginning at 10th level, you require only one full round to prepare a strategy. Each full round of planning increases your strategy bonus, to a maximum of +3.

Prescience

Once you achieve 14th level your ability to strategize provides you with an insight into the strategic approach of others, as well as cause and effect in general. You add your Intelligence modifier to initiative checks and attack rolls with ranged weapons.

The Perfect Plan

You learn to craft fail-proof plans at 20th level. While you or any ally who was accounted for in your plan receive a strategy bonus, any time you or your ally fail an attack roll, skill check or saving throw, you may use your bonus action to instead succeed the roll. Doing so reduces your strategy bonus by 1 when this feature is used.

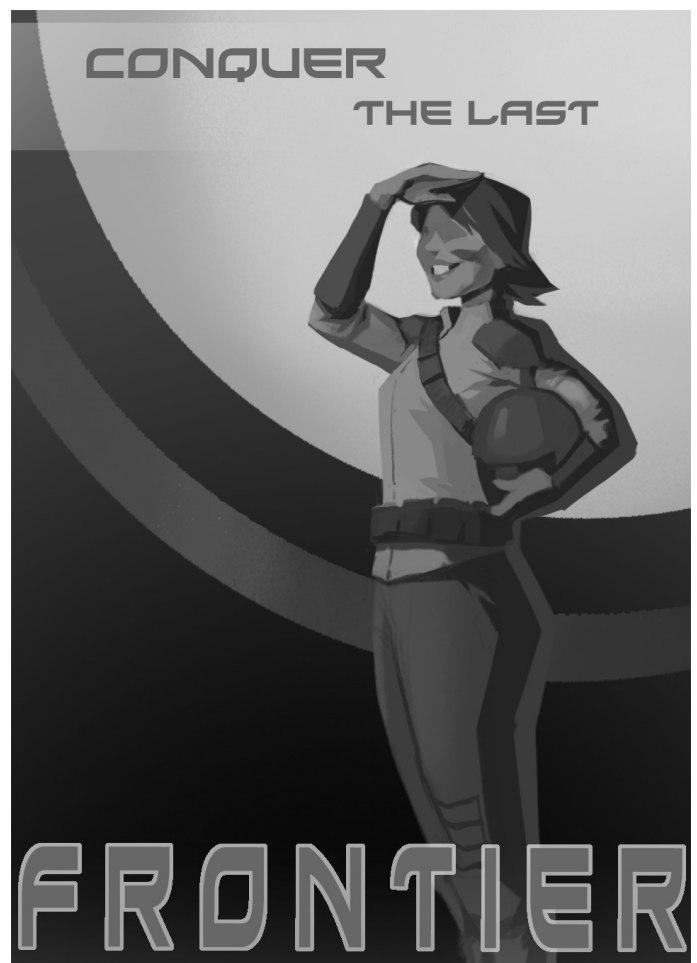



TECHNOPHILE

A CorpNet system should have been secure. In fact, it was secure against pretty much everything. Except, apparently, a street rat with a cobbled together tablet, some wires, and no sense of self preservation. Security was closing in, but they wouldn't be fast enough to keep her from cracking their system wide open.

Overheating engines? Not a problem. Not yet, anyway. The hulking Urroru poured the home-made coolant straight into the tank with a chuckle before taking a swig of it for himself. A few unsure steps and he was back at the helm clutching the controls with a bit of a wobble. The ship might crash alright, but it wouldn't be because the engines failed.

"I can do this!" the tech hollered from halfway inside the floor, where she was ripping cords out by the handful. The detonator kept ticking down, and everyone watched the red numbers nervously. The tech paid them no mind as she bypassed the explosive hardwired into their navigation and ripped out the crucial power supply just in time.

At their center the technophile is not a simple mechanic or operator, they seem to have an instinctual knowledge of the innerworkings of the most advanced machines.

Level	Prof. Bonus	Class Features	Prof. Slots
1st	+2	Jury-Rig, Augment tools	14
2nd	+2		
3rd	+2	Aptitude	+1
4th	+2	Ability Score Improvement	
5th	+3	Overclock	
6th	+3	Aptitude	+1
7th	+3	Augment Equipment	
8th	+3	Ability Score Improvement	
9th	+4		+1
10th	+4	Technical Expertise	
11th	+4		
12th	+4	Aptitude, Ability Score Improvement	+1
13th	+5		
14th	+5	Superior Overclock	
15th	+5		+1
16th	+5	Ability Score Improvement	
17th	+6		
18th	+6	Aptitude, Ability Score Improvement	+1
19th	+6		
20th	+6	Upgrade Mastercraft	

Abilities and Skills

For the Technophile, machines simply make sense. Some might claim they whisper to them in their own way, others say it is just that since they follow rules and are consistent then the rest is just simple intuition. The technophile uses their jury-rigging ability to fix up and augment their team's gear, as well as make the most of their weapons and vehicles.

These technological wizards never see garbage in damaged machines, only valuable salvage. Their spare time is spent learning about the latest developments in computer, engine, armor and weapon tech. Their spare time is spent cobbling together gadgets and weapons or taking them apart.

Place in the Galaxy

Engineers and Technophiles make up the backbone of the economy of every industrialized civilization in the Arc. In terms of training and education, the Technophile may be little more than a talented hobbyist. In the end the distinction come down to passion, for those that wear this badge, technology is an obsession.

Turning to a life of adventure often serves as an opportunity to indulge their preoccupation. How else can an intrepid technophile gain the opportunity to disassemble ancient military robots, break into sophisticated computer networks, and test homemade engine parts if not on the frontier of the Arc amid other equally reckless free spirits.

Technophile Characters

Technophile rarely ever come from backwater worlds - although it is not unheard of. As you build your own technophile consider that their passion probably preoccupied them during their education. The motivations will also equally be seen through the lens of their technical interests. Have you always been technically inclined, or did it arise from your schooling? Did you take up work that let you use your talents and interests, or were your hobbies hidden while you worked in some other field?

Remember that Technophiles don't automatically become inventors and engineers. You could just as easily be a leet hacker, rocket jockey, or even an ancient technology specialist. As with all classes, who you are and what you can do is defined more by your backgrounds and your proficiencies than by your class.

Class Features

As a Technophile, you have the following class features.

Hit Points

Hit Dice: 1d6 per Technophile level

Hit Points at 1st Level: 6 + your Constitution modifier

Hit Points at Higher Levels: 1d6 (or 4) + your Constitution modifier per Technophile level after 1st

Proficiencies

Saving Throw Proficiencies: Dexterity, Intelligence

Proficiencies: Computers, Engineering, Vehicles and Repair Kit.

Proficiency Slots: 14

Jury-Rig

At 1st level you are naturally savvy with technology. This feature has two functions; the first is to attempt to repair a device rapidly and for a limited time. After one minute of work a damaged device can be returned to working order for 1 minute, + Intelligence modifier. The Second is to cobble together a fully functional device that will

only last for a limited number of uses. At the GM's discretion, you can device a device such as a weapon or tool from available components that has 1 + Intelligence modifier uses before it breaks. You require several minutes to work uninterrupted to use this feature.

Augment Tools

Beginning at level 1, for the cost of a standard toolkit you can upgrade this equipment to a Masterwork (+1) toolkit. At level 6 you can acquire a +2 Masterwork kit at no additional cost, and at level 12 you can purchase a +3 Masterwork kit for no additional cost.

Aptitude

At level 3 you learn to understand the language of machines and technology, figuratively speaking. You have 1 technical aptitude at your disposal, taken from the following list. You gain an additional aptitude at levels 6, 12, and 18.

Hacker. You have Advantage on Programming skill checks made to break security through computer hacking.

Patch Job. When you repair a device, armor, or mechs, it regains 2d6 additional hit points.

Percussive Maintenance. Slapping a damaged machine or device for 1d4 damage, it will return to peak functionality for one round.

Perfected Repair. Taking the time to repair a piece of equipment with the repair skill will restore it to full hit points. This can be done once per short rest.

Quick Repair. You can repair a device in half the usual time.

Stack Overflow. Programs that you write with the Programming Principles skill are automatically Masterwork (+1) programs, with no additional investment of time or difficulty.

Superior Salvage. When you salvage equipment, you are better able to remove usable components. This translates into an additional +1 Credit modifier for salvaged tech.

Superior Sensors. You have Advantage on Sensor Scan skill checks.

Tactical Targeting. You have advantage on attack rolls made with targeting systems, such as shipboard weapons.

With a box of scraps. You gain Advantage on Jury-Rig checks to build a temporary device.

Xenotechnologist. When using alien equipment, you have no disadvantage.

Ability Score Improvement

When you reach 4th, 8th, 12th, 16th, and 20th

CLASSES

level, you can increase one ability score of your choice by 2, or you can increase two ability scores of your choice by 1. As normal, you can't increase an ability score above 20 using this feature.

Overclock

Once you have reached 5th level you develop the ability to cause an electromechanical device to over perform for a short period, before breaking down.

To use this ability, you must be able to tinker with the device for at least one hour and make a successful jury-rig check as shown on the table below. If your check is successful, it gains one of the Overclock abilities of your choice. At the end of the period shown on the table, the device breaks down, and requires extensive repairs before it can be used again.

Improvement	DC	Duration
Ranged Weapons		
+1 to damage dice	15	4 attacks
+2 to damage dice	20	2 attacks
+1 to hit in normal range	10	10 rounds
+2 to hit in normal range	15	3 rounds
+1 to hit in long range	15	5 rounds
+2 to hit in long range	25	2 rounds
+10m to normal range	15	2 attacks
+20m to normal range	25	1 attack
Electronic Devices		
+1 skill check	15	10 minutes
+2 skill check	20	6 minutes
+3 skill check	25	3 minutes
+10% effective range	25	4 minutes
Vehicles and Ships		
+1 on initiative checks	20	6 rounds
+2 on initiative checks	30	3 rounds
Speed up 10%	20	1 hour
Speed up 20%	30	20 minutes
+1 to Pilot checks	25	5 hours
+2 to Pilot checks	30	2 hours

The duration begins the moment it is first activated and used. At the end of this duration the device shuts down and is broken. In the case of complex multi-part equipment such as vehicles, only the modified parts are disabled (engine, sensors, weapons, navigation, etc.). The DC to repair the damaged equipment is the same as the DC to Overclock, and will generally require parts and

tools. The cost of the parts to repair are based on the specific device.

Augment Equipment

Once you've reached level 7 you are able to obtain and improve to vastly improve your equipment. For the cost of a standard device, energy weapon, or powered armor you can purchase this equipment at +1 Masterwork. At level 15 you can acquire a +2 Masterwork equipment at no additional cost. This does not grant you the ability to create masterwork equipment on demand, nor to upgrade your existing equipment. You can identify and purchase that equipment at no additional cost.

Technical Expertise

Beginning at 10th level you develop a superior understanding of your technical ability. Choose from Computers, Repair, or Cyber Systems. You receive twice your proficiency bonus with the skill you select.

Superior Overclock

At 14th level you can overclocked devices with supreme confidence and skill. You add twice your proficiency bonus to your Jury-Rig skill checks to Overclock a device, and the duration is doubled.

Upgrade Mastercrafter

Once you reach 20th level you achieve a kind of technomancy. You can upgrade any equipment to mastercraft, by making an appropriate Jury-Rig check and spending the Credit and experience cost. You cannot create mastercraft from parts or invent new devices or prototypes with this ability.



MULTICLASSING

Character's will sometimes choose to diversify their skills by gaining levels in more than one of the standard classes. Multiclassing lets you combine abilities to achieve a character that is not easily defined by one of the standard classes.

If you choose to multiclass, you may gain a level in a new class whenever you advance to a new level, rather than attaining a level in your current class. Some traits of your character or based on your total character level, which is the sum of all the levels in all the classes you possess.

With each level you gain in a new class you sacrifice some of your potency for diversity. Taking even one level in a second class means you will most likely never achieve the highest-level abilities of your class.

Bonus Proficiency and Prerequisites

Characters cannot simply wake up one day and decide they are going to change careers from a Combat Specialist to a Scientist. It takes time, training, and a significant amount of pre-existing knowledge to transfer from one class to another. To enter in to a new class you must have the prerequisite Ability Scores as outlined below.

When you enter a new class, you gain two bonus proficiencies. If you already possess these proficiencies, you can ignore the ability score prerequisites, but you do not gain any additional proficiency slots or a selection of proficiencies from the same ability score as you would from background and class overlapping.

Class	Bonus Proficiency
Agent	Stealth, Security
Combat Specialist	Light Armor, Simple Guns
Diplomat	Insight, Persuasion
Explorer	Survival, Wilderness
Insurgent	Simple weapons, Vehicles
Marshal	Light Armor, Persuasion
Science Specialist	Computers, Sciences
Spacer	Acrobatics, Piloting
Spiritualist	Intuition, Persuasion
Tactician	Investigation, Deception
Technophile	Engineering, Repair Kit

Advancement

Each new level, regardless of what class you choose to advance in, is based on your current experience and total character level. The Progression Table in Section 1 shows the total experience needed to advance to the next level based on your total character level.

Hit Dice

When you gain a level in a new class you roll a new hit dice for that class and add that to your hit point total. If your classes have different hit dice, keep track of them separately for resting and healing purposes. For example, if you are a 5th level Agent and a 2nd level Technophile you would have 5d8 and 2d6 hit dice, however, if you were a 4th level Combat Specialist and 4th level Marshal you would simply have 8d10 hit dice.

Proficiency

Regardless of what classes you have your proficiency bonus and number of specialties is based on your total character level, as shown on the Progression Table in Section 1.

Class Features

Except for the abilities listed below, the abilities granted from class features are wholly cumulative and can be used together to augment one another.

Ability Score Bonus

Bonuses to your ability scores are based on your class level, and not your total character level, meaning that even if your total character level is 4, you won't receive an ability score increase until you achieve 4th level in one of your classes.

Extra Attack

This feature does not add together and having Extra Attack from more than one classes will not grant you additional attacks.

Multi Attack

This feature is cumulative, so gaining this feature from the combat Spec and the Insurgent will give you cumulative additional attacks.



SECTION 05 BACKGROUNDS

Your character is not simply a set of numbers, each is a personality with their own history, their story brought to life through you, and your imagination. The small details, their background, education and defining life events are described in this section. But your background also has meaningful impact on your character – how many specialties they have, and how they see the galaxy.

CHARACTER DETAILS

The first impression you will get to make as your character to the other players is your appearance, name, and attitude. Do you strut around like you own the station, or do you keep to the periphery? Are you a hulking brute, or a timid bespectacled intellectual? Consider these things as you add details to your character.

Name

Every species is known to use common proper nouns to differentiate individuals. You should consider you name carefully – is it your real name, a nick name, or an alias to protect your identity. It is up to you.

Gender

Almost all the known races display sexual dimorphism, and there is no mechanical impact on playing a male or female of any species. While Thothid may develop sexual dimorphism at a later point in their life cycle adolescents are ungendered and choose a pronoun if they want. Neither Quithal nor Magoi have no gendered pronouns. Gender has different expectations depending on the cultures of the species. In Ba'alur cultures women are expected to fill the role of advisors, diplomats, and leaders, while Ephari are a strict meritocracy where gender is irrelevant and only performance matters, in fact Ephari don't even reproduce sexually.

Likewise, sexual orientation has no bearing mechanically, but can be an interesting part of your personality. In Seyvul cultures homosexual behavior was never stigmatized and monogamy seems unusual as well so their perspective on sexual activity may shock more conservative Colonials. Xhu and the Emphyreans tend to ignore romance and sexual matters and see reproduction as the ultimate point. A lovelorn Xhu would be a tragic outcast from his culture, as would an Emphyrean temptress. All these elements can be taken into account when developing your history and story.

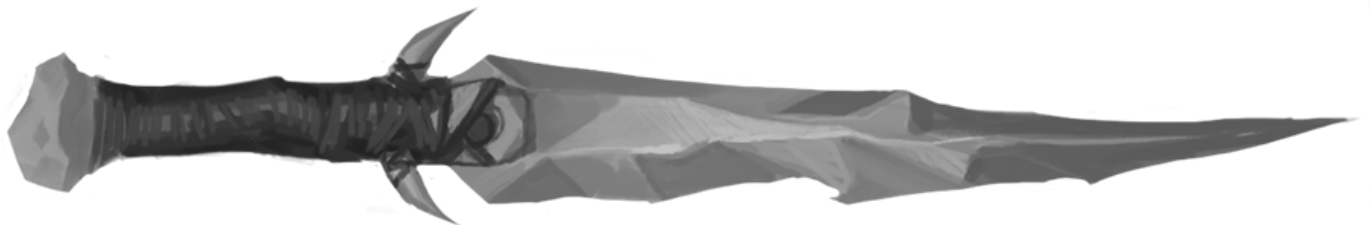

Physical Characteristics

While you are free to decide the appearance, weight, and height of your character within the general confines of your species, also consider what your ability scores might say about your character's physique. A character with a high strength and constitution may be larger than the average member of his race. If you have a high dexterity and charisma perhaps you are slender and alluring. You are also free to choose your character's age, complexion, and coloring.

Species	Average Height	Average Weight
Ba'alur	1.9 meters	85 kg
Colonial	1.75 meters	77 kg
Ephari	1.85 meters	55 kg
Empyrean	1.8 meters	80 kg
Ixaxian	1.3 meters	125 kg
Seyvul	1 meter	30 kg
Tothid	1.95 meters	65 kg
Urroru	2.2 meters	135 kg
Xhu Akreen	1.8 meters	70 kg



BUILDING A BACKGROUND

Your background is constructed from three parts; your education, your profession, and your defining event. Together these will paint a picture of your history before becoming an adventurer, and perhaps some of your motivation for taking on a mercenary life.

Educations

To begin building your background, select your Education. This is where you developed most of your proficiencies, if not your class abilities. Educations will provide some small bonus proficiencies in skills, languages, or tools.

Each Education will also include ten Personalities that you could use to describe an aspect of your character's attitude and persona. The Personality traits listed are those closely associated with each educational background, but you are free to choose any you like. It is your character, and these should serve only as a guide to help you.

Apprentice

From long-haul ships and deep space stations to remote colonies on the edge of the Arc, it is common for people to learn their trade in an apprenticeship, developing their skills as part of the operations and maintenance of their home. You received this kind of training as part of your daily livelihood.

Skill Proficiencies: Piloting

Tool Proficiencies: Repair Kits

d10	Personality Trait
1	I have a lot of patience, because I'm used to waiting for what I want.
2	I collect hobbies, but never really get attached to any of them.
3	If something breaks, I will try to fix it, whether I have the ability to actually do so or not.
4	I have a deep-rooted belief in the importance of my work and will tell anyone who listens how great it is.
5	I am comforted by the blackness of space. It feels like home to me.
6	Being planet-side is weird to me. I don't like being so tied down.
7	I think I can fly anything with thrusters and a helm.
8	I complain constantly when an engine sounds 'wrong' even when there's nothing wrong with it.
9	I think it's important to learn from my elders, even when they don't have anything useful to teach me.
10	I make weird small-talk with people, because I'm not used to meeting anyone new.

Research University

Knowledge is power, and an education at a premier facility is worth a fortune. You were educated in a facility designed to teach advanced skills such as medicine, sciences, or advanced engineering principles. Although other types of curriculums could be available such as philosophy or mathematics.

Tool Proficiencies: Laboratory

Languages: One of choice

d10	Personality Trait
1	I love books and will spend far too much money to buy one I've never seen before.
2	I disapprove of people who failed to receive a higher education.
3	School was the best time of my life and I still tell stories about how great it was.
4	I kept all my textbooks, because I think they might be useful someday.
5	I love to learn and will study enthusiastically about anything that catches my interest.
6	I was never very good at school, even though I graduated with honors.
7	I still hate everyone I knew in University.
8	I studied something weird and completely useless just because I needed the extra credits.
9	I was in my top-ten percent, because I was on stimulants for my entire senior year.
10	I am still close friends with several people I graduated with, even though we almost never see each other in person.

Military Academy

Common among the Imperium of Sol and the Magisterium, these academies are designed to train the next generation of military leaders and strategists. You were trained in one such institution, regardless of whether you later joined the military.

Skill Proficiencies: Simple weapons

Tool Proficiencies: Vehicles

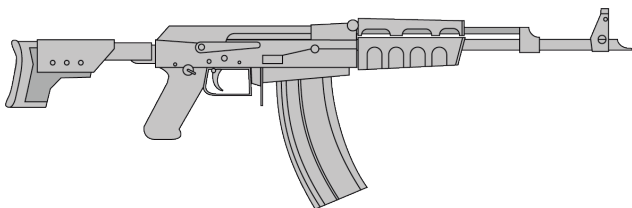

d10	Personality Trait
1	I am unreasonably familiar with most modern weapons, even if I don't know how to use them.
2	I still have my cadet uniform hidden away in a box somewhere.
3	I mouthed off to a ranking commander and he still hates me.
4	My squad are my best friends, and I trust them with everything.
5	I dropped out because I cannot hit the broad side of a barn with any weapon.
6	I was recruited into the Intelligence Corps before I could graduate.
7	I was the absolute worst student my academy ever had.
8	I still believe I was in the military, even though I never graduated.
9	My whole family went to this academy, and so did I.
10	I polish my boots every morning even though I know there's no actual point to it.

Primal

Many worlds, both alien and colonial have reverted to or never developed advanced education programs. You are from one such world, educated in the wilds of a preindustrial civilization where you learned the ways of your people. Advanced technology is still something of a wonder to you, but you are adapting.

Skill Proficiencies: Survival

Tool Proficiencies: Hunter's Kit

d10	Personality Trait
1	I hate cities and will only go into one if I absolutely must.
2	I can dress the carcass of just about anything.
3	I am weirdly snooty about farm raised meat.
4	I probably won't notice inclement weather unless it's directly causing me trouble.
5	I am reasonably good at homesteading and tend to repair my own gear when I can.
6	I like animals, even if I'm no good at handling them.
7	I find that nature is more important than technology, even when I need technology to survive.
8	Crowds make me nervous.
9	I don't like machines, and struggle when I have to rely on them for anything.
10	I am completely willing to eat anything that remotely resembles food.

BACKGROUNDS

Lyceum

Billions of students graduate each cycle from schooling facilities around the galaxy. Given a basic set of skills and broad spectrum of minor specialties that they can integrate into society with minimum job training. You have completed the basic educational program of one of the major civilized worlds, gained the simple skills that will allow you to survive in the galaxy.

Tool Proficiencies: Vehicles

Languages: One of choice

d10 Personality Trait

- 1 I am incompetently conversational in one language besides my own.
- 2 I have an unrealistic hatred for uniforms.
- 3 I am ridiculously passive-aggressive to anyone who looks like my former math teacher.
- 4 I enjoyed school and want to go into higher education.
- 5 I got through school on raw talent and never studied, so I think I'm smart enough.
- 6 I can, without error, always tell you when it's time for lunch.
- 7 I spent all my time in the library and have a strange but compressive knowledge about something useless.
- 8 School was the best time in my life, and I've never gotten over it.
- 9 I was bullied and will pick a fight with anyone who seems like that kind of person.
- 10 I learned early on you can't trust anyone.

Corporate Academy

Private educational curriculums exist throughout the galaxy, where elites are trained by experts in a variety of subjects, often far surpassing standard educations, but at serious expense. You received your education at one of these elite corporate academies,

Skill Proficiencies: Computers

Languages: One of choice

The challenge of Choice

There is a large selection of background components to choose from, but don't let this overwhelm you. These are tools to help you bring your character to life and make them more real. Like any tool, if its not right for the job, use something else. In this case, make up your own background.

d10 Personality Trait

- 1 I try to be up-beat and sociable, even though I hate small talk.
- 2 I know better than to talk about where I'm from. Makes people suspicious.
- 3 I have a lot of 'school friends' who are now the rich and powerful.
- 4 I believe in law and order, even if it doesn't work for everyone.
- 5 I was a terrible student, and only made it through school because my charm.
- 6 I was a scholarship student, I know that hard work is the most important thig in life.
- 7 My family is New Money, and the other students gave me trouble for it.
- 8 I was in detention every single day. I'm still a rebel and a trouble maker.
- 9 I was on the sports team, and still think I could have made it as an athlete.
- 10 Dorm rooms were the best thing that ever happened to me.

Streetwise

You were educated on the roughest streets that the Arc. For whenever reason, you never received much of a formal education, but learned to survive in the gutters and slums, by whatever means necessary.

Skill Proficiencies: Deception

Languages: One of choice

d10 Personality Trait

- 1 I will sometimes pocket things without thinking about it.
- 2 I am prone to over-eating when there's food around and will stash snacks for later.
- 3 I know the currency exchange in nine different currencies off the top of my head.
- 4 I was the Crime Lord's favorite.
- 5 I know all the local Fences, but none of them like me.
- 6 I can always roll double-sevens on any dice I get my hands on.
- 7 I don't understand why people think stealing from the rich is wrong.
- 8 I will eat just about anything, even if it's long past its' good-by date.
- 9 I always carry hairpins, just in case I need to make a lock pick.
- 10 I automatically memorize the route in and out of anywhere I travel.

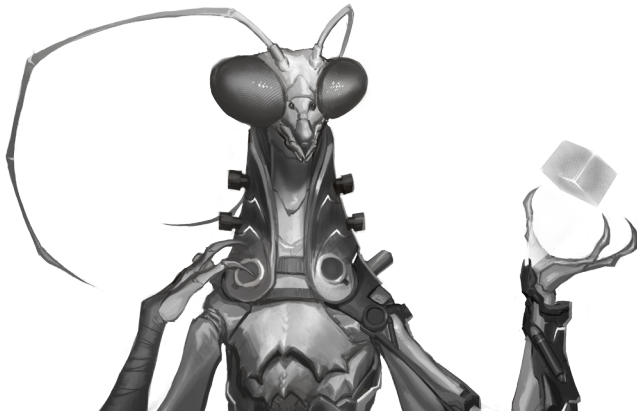

Technical College

Across the Arc many are trained in specialized vocational institutes for a trade or service, such as pilot schools, ship systems, information technology. You were educated in a formal technical college, giving you a well rounded education in technology.

Skill Proficiencies: Computers

Tool Proficiencies: Repair Kit

d10	Personality Trait
1	I think I can fix anything enough to get it from 'busted' to 'kind-of'
2	I like to take things apart in my spare time.
3	New skills interest me and I will seek out people who know more about something than I do.
4	I came from a wealthy family and went into a vocation despite their wishes.
5	I will work hard at anything chose to take on.
6	I went into vocational school to avoid whatever my family wanted to do instead.
7	I didn't graduate but ended with twice the number of credits I needed to graduate.
8	New tech interests me, and I can be distracted from almost anything if someone provides something new to play with.
9	I like to cook and learned to do it well when I had nothing to eat.
10	Don't talk to me before I have my morning coffee. Just don't.

Creating Your Own

Characters might learn their Skills in several other institutions and environments. Creating a unique education is simple. All Educations provide offer up a proficiency that reflects the type of educational environment. Your custom Education should fit this mold, offering proficiency in a Skill and a unique flavor.

Profession

In Advent Horizon, adventurers come from all walks of life, and in many cases from backgrounds that are surprising and unexpected. Your Profession represents what you did for a living prior to the event that lead you to a life of adventure. Your profession may provide you with up to two proficiencies or languages, or a bonus to starting Credit and starting reputation - or a combination of all totaling four.

Profession and Class may be related but are not mutually exclusive. A soldier may forsake violence becoming a spiritualist, and an aristocrat might be a manipulative Tactician as everyone expects. It is up to you to make the story your own, but remember that some combinations, lacking any story or justification might diminish the character you want to play.

Your choice of profession also includes a selection of ideals which may help you develop your character's outlook and personality further. Of course, you may or use the suggestions as inspiration for ideals of your own advent.



Aide de camp

You were a member of the diplomatic corps of an organization or government, serving a more prestigious ambassador or diplomat as a staff member and aide de camp.

Languages: One of choice

Starting Reputation: +1

Starting Credit: +2

d8	Ideal
1	Ambition. I will do whatever I have to in order to move my goals forward.
2	Cunning. There is always a way out of any situation, if you think about it for a while.
3	Caution. I take care in everything I do, because anything could go wrong.
4	Determination. Giving up is for the weak.
5	Efficiency. There is always a better way to do things.
6	Honesty. I rarely see any reason to lie, even if it might be to my benefit.
7	Loyalty. I am dedicated to something or someone.
8	Conquest. The only way forward is through war.

Aristocrat

Born to a prestigious lineage, you have hardly had to work for most things in your life. Typically, the aristocrat has few or no meaningful responsibilities outside of maintaining social appearances and connections.

Starting Reputation: +1

Starting Credit: +3

d8	Ideal
1	Tradition. My ancestors knew things we have forgotten, we must maintain the old ways.
2	Conviction. I'll never back down from doing what's right.
3	Charity. People need my help, and I do my best to answer that call.
4	Superiority. I'm better than people without benefit of a full formal education and upbringing.
5	Harmony. We can all work together, we can all win. United we're strong.
6	Heritage. My family is old, and it falls to me to defend my family's legacy.
7	Wealth. Money is power, and I need more power.
8	Freedom. Good judgement comes from experience, and experience comes from bad judgement.

Artist

You employed your creative talents to make a living as an artist or designer of some kind. Even in the distant future creative professionals are in demand.

Tool Proficiencies: Artist's Supplies

Languages: One of choice

Starting Reputation: +1

Starting Credit: +1

d8	Ideal
1	Wonder. The universe is a tapestry of beauty which leads me forward.
2	Self-Reliance. You can't trust people, they'll always let you down.
3	Hope. There is always a way out of any situation, if you think about it for a while.
4	Determination. I have a fixed destination in mind, and nothing will stop me from reaching it.
5	Nihilism. The only meaning in life is what we create for ourselves.
6	Creativity. Imagination is the bridge to the unknown.
7	Kindness. Being good to others cost me nothing but can change the universe.
8	Aspiration. I believe that working hard is the way to success.

Corporate Management

The Corporations represent a political and economic force to be reckoned with, and for a time you served as the white-collar middle management of one of these behemoths.

Skill Proficiencies: Bureaucracy

Starting Reputation: +1

Starting Credit: +2

d8	Ideal
1	Ruthlessness. I will do whatever I must to achieve my goals.
2	Control. It's my way or the highway.
3	Wealth. I've been poor. Never again.
4	Respect. People need to treat me with the respect I deserve.
5	Efficiency. There is always a better way to do things.
6	Community. I care about people working together, being part of something greater.
7	Aspiration. I'm going to become a major name, everyone is going to know me.
8	Pride. I worked hard to get where I am, and I'm proud of that.

Criminal Enforcer

Owing to debt, bad life choices, or just a bad attitude, you made your living as a criminal enforcer for the lords of the underworld.

Skill Proficiencies: Intimidation, Simple weapons

Starting Reputation: +1

Starting Credit: +1

d8	Ideal
1	Community. I made hard choices in a hard world, but I did it to protect my people.
2	Avarice. More money, more drugs, more everything, that all I care about.
3	Respect. You better not step up; my street cred is the real deal.
4	Nihilism. I've lost everything worth caring about. All that's left is the next fight.
5	Redemption. I can never undo my crimes, but I can make things right.
6	Independence. I spent long enough under someone's thumb. I'll do whatever I want.
7	Loyalty. In the ghetto you got to stick together. I'm no snitch.
8	Ambition. I'll rise to the top of the underworld through my will and power.

Demagogue

Many of the civilizations of the Arc are democracies, and you exploited weakness of the democratic system: the people can give their power away. As a populist, taking head, or political official you made your living as a demagogue, revolutionary, and rabble-rouser.

Skill Proficiencies: Deception

Starting Reputations: +2

Starting Credit: +1

d8	Ideal
1	Wealth. The message can be bought.
2	Conviction. I'm a true believer and take my cause very seriously.
3	Respect. I crave people's respect and confidence.
4	Greed. Money and fame are the only things I want.
5	Power. Once I control the people, I can control the world.
6	Freedom. Think for yourself, question authority!
7	People. I just want everyone to like me, I'm everyone's friend.
8	Nation. I put my people first, above filthy aliens.

Enlistee

The military institutions of the Arc enlist millions of techs, officers, and grunts. You were an enlisted member of an armed forces following your education and received minimal training, whether you saw actual combat or not.

Skill Proficiencies: Simple Guns

Starting Reputation: +1

Starting Credit: +2

d8	Ideal
1	Determination. Pain is just weakness leaving the body.
2	Truth. I'll speak my mind, and I'll tell you how it is, even if it hurts.
3	Loyalty. No man left behind.
4	Independence. I'm done taking orders from anyone.
5	Might. Strength is the one constant in the universe, the strong survive.
6	Nation. I fought to preserve and protect my people's way of life.
7	Superiority. Only through war is a man's mettle revealed.
8	Peace. I've seen enough violence for a lifetime. Never again.

Entrepreneur

The Arc is a place with all kinds of opportunities, from apps to service industries there are billions of credits to be made for the enterprising individual willing to risk it all. You made your living as one such intrepid venture,

Languages: One of choice

Starting Credit: +3

d8	Ideal
1	Change. The one constant is change, so I must adapt.
2	Innovation. I'm always looking for my next big idea.
3	Efficiency. 1% better is 1% closer to staying alive.
4	Aspiration. I'm going to make it big, I'll be running my own corporation one day.
5	Creativity. Even if it doesn't work doesn't mean it's not worth trying.
6	Hope. I believe that good things are around every corner.
7	Wealth. With capitol come opportunity.
8	Caution. Everyone is up to something.

Government

Like many, you worked in a government position, maintaining the vast bureaucracy of one of the great civilizations. Whether you were a clerk, administrator or agent of some other branch, you were a civilian government work.

Skill Proficiencies: Bureaucracy, Investigation

Starting Reputation: +1

Starting Credit: +1

d8	Ideal
1	Nation. I'm a true patriot, and believer.
2	Caution. No matter where, or when, someone is listening.
3	Process. Doing things, the right way is vital.
4	Community. Service to others elevates everyone.
5	Peace. I refuse to fight, even if it might cost my life.
6	Justice. I'll always fight against those that threaten law and order.
7	Wealth. I've never turned away a few extra credits to turn a blind eye.
8	Power. If I was running things incompetent officials wouldn't be failing the people.

Information Broker

The Arc moves based on the trade in information and secrets. You were one such broker, moving data into the right hands for the right price. While not strictly illegal, this line of work runs awfully close to espionage, and brokering in restricted or sensitive information such as corporate plans or state secrets is dangerous.

Starting Reputation: +2

Starting Credit: +2

d8	Ideal
1	Secrecy. No one knows my real name, everything else is an illusion.
2	Power. Knowledge is power. And I need to know everything.
3	Greed. I don't care who gets hurt so long as I get paid.
4	Logic. Events flow like a river of causality. Critical thinking is the boat for that river.
5	Sincerity. The world is full of lies, I can't help but be true to myself.
6	Honor. I'm all about the deal, I'll never break a contract.
7	Cunning. The right information is deadlier than any bullet.
8	Paranoia. In a hostile universe everyone and everything is out to get you.

Journalist

While ideals like a free press survived among the colonies, the notion was never enshrined among many other species. None the less you worked diligently to uncover and reveal the truth, and report upon the happenings of the Arc.

Skill Proficiencies: Investigation

Languages: One of choice

Starting Reputation: +2

d8	Ideal
1	Truth. The only real power in the universe is the truth.
2	Knowledge. Information craves to be shared freely.
3	Loyalty. I've never betrayed a source, and I never will.
4	Hope. I've seen enough darkness to know there is always a ray of hope.
5	Determination. I'll always follow a juicy lead, no matter the danger.
6	Patience. It's all about the long game, I wait to act until I have all the info.
7	Justice. The powerful might be above the law, but no one is above the truth.
8	Greed. I'll tell any story for the right price.

Law enforcement

Civilizations that adhere to the rule of law almost universally possess officers to enforce that order. Be it as a militarized force, uniformed police, investigative forensics, or criminal justice advocate you made your living as a member of law enforcement.

Skill Proficiencies: Simple Guns

Tool Proficiencies: Forensic Kit, Vehicles

Starting Reputation: +1

d8	Ideal
1	Order. The rule of law is more important than one person's justice.
2	Might. Force is the answer to crooks and criminals.
3	People. I'll always protect those who cannot protect themselves.
4	Justice. Sometimes doing what's right, and what's legal, aren't the same thing.
5	Greed. Maybe I was on the take, but what's the harm.
6	Truth. Without evidence and truth there can be no justice.
7	Community. I'll always work to protect my people from criminal scum.
8	Kindness. If I can help and reform just one person, I'll have made the universe better.

Minister

The churches and religious factions of the Arc still attract adherents and believers. You worked as a minister or monk of one of these various traditions and belief systems.

Skill Proficiencies: Insight, History

Starting Reputation: +1

Starting Credit: +1

d8	Ideal
1	Wonder. We are all part of something greater, and that gives me strength.
2	Compassion. I'll never turn away someone in need.
3	Community. Oh, come ye faithful, and hear the word.
4	Tradition. The old ways were best, and we need to preserve our way of life.
5	Avarice. I don't believe, or care, I just love the money and the power.
6	Self-Reliance. The universe helps those with the will to act.
7	Nihilism. I had faith once, but it is gone. I know now the truth.
8	Faith. Anyone who disagrees is a heretic, and must be converted, or eliminated.

Personality

The entertainment industry in the arc is worth septillions of credits every solar year. You made your living as an entertainer and performer.

Skill Proficiencies: Performance

Starting Reputation: +3

d8	Ideal
1	Cunning. I let people see the pretty face and think that's all there is.
2	People. Touching people's hearts when I perform means everything to me.
3	Tradition. My art is the craft of the ancient, which I proudly carry on.
4	Greed. I know that money and fame can buy happiness.
5	Beauty. When I shine, the universe shines with me.
6	Culture. I take special care with my appearance and know all the current trends.
7	Aspiration. Someday every world will know my name. Count on it.
8	Avarice. Why should I care what anyone else wants?

Petty Criminal

The Arc is an unforgiving place, and it is no surprise that the down-trodden look to petty crime to survive. You were a small-time crook, con-artist, thief or dealer, who did what they had to get by.

Skill Proficiencies: Sleight of Hand

Tool Proficiencies: Vehicles

Languages: One of Choice

Starting Reputation: +1

d8	Ideal
1	Greed. Whatever it takes to get what I want.
2	Redemption. I made some bad choices, but now I have a chance to start over.
3	Aspiration. I came from nothing, but soon I'll be calling the shots.
4	Kindness. I've known starvation and hunger I'll always help those in need.
5	Revolution. The poor must rise and consume the rich.
6	Hope. When you have nothing, hope can keep you alive.
7	Might. Never show weakness, that gets you killed.
8	Honor. I may be a thief, but I only steal from those with enough to share.

Researcher

As part of an organized effort, either private or academic, you made your living as a researcher. Research in the arc takes on many forms, including exploration, archeology, or working in a scientific installation.

Skill Proficiencies: Sciences

Languages: One of choice

Starting Credit: +2

d8	Ideal
1	Caution. Science without conscience destroyed countless civilizations.
2	Knowledge. The shadow of ignorance can only be banished by knowledge.
3	Superiority. My knowledge and education set me above the common rabble.
4	Understanding. Knowledge is the engine to find meaning.
5	Truth. The pursuit of truth is the heart of science.
6	Logic. Reason and critical thinking are the only thing that can push us forward.
7	Respect. My discoveries have shaped science. People should respect intellect.
8	Life. In all the cosmos, life is the greatest mystery. It should always be cherished.

Roughneck

Industrial blue-collar work in the space is often performed by machines, but advanced robotics are expensive and unskilled laborers are not. You worked as a roughneck such as a miner, station worker, farmer, or other infrastructural role.

Skill Proficiencies: Engineering

Tool Proficiencies: Repair kit

Starting Credit: +2

d8	Ideal
1	Hard Work. No one will give me anything in life, only my efforts matter.
2	Efficiency. There is no use wasting time of trivialities. I have work to do.
3	Community. The working people are more important than the elites.
4	Loyalty. I'll never break my word, and never betray a friend.
5	Determination. I'm used to a rough living, so I never give in when things get rough.
6	Cunning. If I can't fix it, no one can.
7	Tradition. Been doing things this way for five generations. Not going to change now.
8	Nation. Me and mine have worked hard for what little we have, and no one is taking it.

Scoundrel

Living by your wits, your charisma, and your complete lack of a moral compass you got by as a scoundrel and a con-man. Unlike petty criminals, your scores were larger longer cons, big heists, and serious felonies. This is a dangerous life, one that is often short.

Skill Proficiencies: Deception

Starting Reputation: +3

d8	Ideal
1	Avarice. It's not just money, I want everything.
2	Cunning. I can talk my way out of anything, if I have the time.
3	Sincerity. I probably won't tell the truth, but I won't live a lie.
4	Self-Reliance. I don't take handouts, but I do take what I want.
5	Rebellion. I live to stick it to the corporations one scam at a time.
6	People. Charming people is second nature to me, and I love it.
7	Revenge. I'll find some way to get back at those who wronged me.
8	Freedom. I only care about things that immediately benefit me.

Services

You were a blue-collar service industry worker, such as sales, hospitality, temp clerks, secretarial worker, or cleaning. It wasn't glamorous, but it paid the bills and let you focus on your true passion.

Skill Proficiencies: Insight, Persuasion

Languages: Two of choice

d8	Ideal
1	Charity. People need my help, and I do my best to answer that call.
2	Nihilism. There is nothing in the universe but greed and selfishness.
3	Culture. I love what's new and hot, and I'm always what's new and hot.
4	Aspiration. I will be more than my humble roots, no matter the cost.
5	Honesty. I spent my life lying, and I'll never do that again.
6	Hope. The most important thing in the universe the chance for a better tomorrow.
7	Malice. Years of slaving for pennies, I know hate. I pop the balloons of small children.
8	People. I'll talk your ear off if you give me the chance. Our connections drive us.

Systems Tech

Technology is part of life for the arc. It takes a great deal to maintain the constant operations of the computer and industrial facilities that support you were one of the millions of techs that maintain the infrastructure of the vast galactic civilization of the Arc.

Skill Proficiencies: Computers

Languages: One of choice

Starting Credit: +2

d8	Ideal
1	Logic. Cause and effect, the universe is binary if you look hard enough.
2	Greed. A few credits can make me anyone's friend.
3	Control. I can manipulate the systems on which we all rely. And I know it.
4	Efficiency. I'll automate anything I have to do more than once a day.
5	Patience. I'm not thinking three moves ahead, I'm already three games ahead.
6	Power. He who controls the flow of information controls the galaxy.
7	Cunning. I don't have a backup plan, I have three contingencies I already enacted.
8	People. Technology is just another road for us to connect with other people.

Vagabond

Few would choose to live as a vagabond, moving from planet to planet, city to city for work. For some it is a way to freedom, other a way to stay off the grid. For whatever reason you made your way as an itinerant worker and beggar, never staying in one place too long.

Skill Proficiencies: Two of choice

Starting Reputation: +1

d8	Ideal
1	Secrecy. No one can know what I did, or who I really am.
2	Kindness. My hard life has taught me that helping those matters most.
3	Self-Reliance. I'll survive, no matter what.
4	Knowledge. I lived as a pilgrim, seeking the ancient and unknowable.
5	Nihilism. I once heard that the problem with life is that no one gets out of life alive.
6	Avarice. Pop it, smoke it, slam it, snort it - I don't care I love it.
7	Hope. Lightyears packed in like cargo, all for the chance at a better tomorrow.
8	Freedom. I come and go as I please, when I please. The universe is my playground.

Creating Your Own

Professions, like educations, can be practically anything. If you wish to create a custom Profession, you have a total of four slots to distribute, and up to two of them can be skill, tool, or language proficiencies, then the remainder becomes a bonus to reputation or Credit modifier.

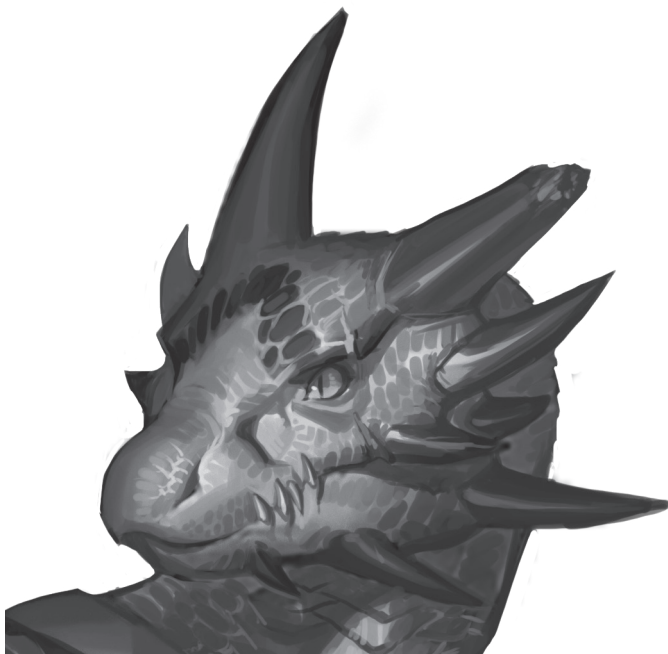

Events

Everyone has a moment that shaped them into who they are. Below is a selection of events that shape your backstory and legend. This part of your background is often the catalyst that transformed you from an ordinary person to an extraordinary adventurer.

Select one of the events below. Each event offers a selection of minor trinkets for you to select which serves as memento of the event. The event you select will help define the nature of your outlook and has a selection of flaws you could choose from or use as a template to create your own to add depth to your history.



Accidental Enemy

Your actions, whether intentional or not, angered someone so deeply that they vowed revenge on you. Even now, this enemy hunts for you across the Arc.

d6	Trinket
1	A tablet with coded information.
2	A mysterious key.
3	A pendant with an inscription you can't read.
4	A shard of twisted metal.
5	A button off a control panel
6	A silk handkerchief.

d6	Flaw
1	I think I'm much more qualified than I am.
2	I think I'm being honest and true, but really, I'm being rude.
3	I don't listen to direct instructions.
4	I get blackout drunk whenever I can and pick fights about anything.
5	I will loudly comment on anything I see.
6	I cannot keep a secret to save my life.

Criminal Conviction

You were convicted and sentenced for crimes committed. Whether you escaped or served your time, your prison experience changed you.

d6 Trinket

- 1 A spent bullet.
- 2 A coin with heads on each side.
- 3 A deck of marked cards.
- 4 Part of an engraved gun handle.
- 5 A broken prison shiv.
- 6 A silver lighter with no fuel.

d6 Flaw

- 1 I will steal anything not nailed down.
- 2 I like any vehicle I can do something stupid in.
- 3 I have a gambling addiction.
- 4 I like fire a little too much.
- 5 I cheat at cards compulsively.
- 6 I won't share my food, ever.

Discovered a Relic

You discovered an artifact of significant importance, and your discovery has caught the attention of nefarious forces that are eager to find and exploit the relic you discovered.

d6 Trinket

- 1 An ancient-style pen
- 2 A ceramic slate etched in protogen writing.
- 3 A pendant with an ancient inscription on it.
- 4 A bead from an unknown civilization.
- 5 An Old Earth insect encased in resin.
- 6 A sample of green liquid in a sealed vial.

d6 Flaw

- 1 I hoard tools and equipment
- 2 I will pay exorbitant prices for novelties.
- 3 I tend believe just about anything if it involves ancient civilizations.
- 4 I am completely convinced of a conspiracy.
- 5 Secretly I believe my people are an alien experiment.
- 6 I will absolutely run away from any and all confrontation with a specific species.

Discovered a Secret

During your normal life you uncovered a secret with dangerous, Arc changing implications. There are those that will stop at nothing to make sure this secret is never revealed.

d6 Trinket

- 1 A diary in an unknown language.
- 2 A strange senseless letter, written to you from your dead parents.
- 3 A memory card filled with photographs of an alien world.
- 4 A ring of strange metal with a strange alien engraving inside it.
- 5 A fragment of an ancient drift chart.
- 6 An alien communication device of unknown origin.

d6 Flaw

- 1 I will read anything I get my hands on, including classified documents.
- 2 I will do anything to reveal the conspiracy I believe the powers that be are hiding.
- 3 I am convinced that my Secret means something and want to sell it.
- 4 Anyone who asks about what I know is getting an earful.
- 5 I believe that communication devices are all being used to find me.
- 6 Every stranger who is kind to me makes me suspicious of their intentions.



Escaped disaster

You were the sole survivor of a natural disaster that had cataclysmic consequences. Where countless others perished, you and you alone managed to escape unharmed. Some see this as a miracle, others wonder if you were at fault.

d6	Trinket
1	A bit of rubble set into a necklace.
2	A pamphlet for refugee relief.
3	Someone else's ragged emergency blanket.
4	A torn picture you managed to save.
5	A strange terminal access key no one recognizes.
6	The indent card of the person you hold responsible for the disaster.

d6	Flaw
1	I believe that faith protected me, and I know that it will continue.
2	I still flinch at loud noises.
3	When things go bad, I assume they can only get worse.
4	Secretly, I hoard supplies even when times are good.
5	I know I survived because the others were weak.
6	I believe myself to be an indestructible hero now.

Exiled

You held a position of some station among your people, but for some reason you were cast out. Your civilization has, largely, turned their back on you.

d6	Trinket
1	A badge or signet of your family.
2	The documents of Disinheritance.
3	The uniform of your House or Station, hidden at the very bottom of your bag.
4	The key to an ancestral tomb in your old home city.
5	An ancient medal honoring your family.
6	A treasure map from your home world.

d6	Flaw
1	I tend to try and take charge even when I should not be leading.
2	In secret I self-medicate with illegal substances.
3	I lean on my family name because I believe there is nothing else special about me.
4	I would kill to resume my rightful place in the galaxy.
5	I always lie about where I came from.
6	I live in fear of the enemies I made when I had it all.

False accusations

You were falsely accused of some terrible crime, and despite innocence you must live with the constant cloud of judgment following you.

d6	Trinket
1	A warrant for your arrest.
2	A dead camera someone planted on you.
3	A contract with your forged signature on it.
4	The weapon used in a gruesome murder.
5	A coms device that you found.
6	A holo of someone, fleeing the crime you were accused of.

d6	Flaw
1	I will absolutely refuse to lie even when it would be better to do so.
2	I will not sign anything without at least two witnesses I trust.
3	I always assume someone is judging me.
4	I track information about my alleged crime compulsively.
5	I will do anything to prove my innocence.
6	If I get the chance to kill my accuser, I will.

Fled battle

In the heat of a terrible and violent conflict that is well known, you fled rather than fight. Why you fled is irrelevant, now your former comrades and enemies alike know you for a coward.

d6	Trinket
1	Your uniform badge.
2	Your dog-tags or identification bracelet.
3	Unexploded ordinance that should have killed you.
4	Your old uniform.
5	A map of the area where your battle took place.
6	A photo of you with your squad.

d6	Flaw
1	Secretly I am a coward at heart.
2	I refuse to associate with the military because I am afraid of being recognized.
3	I'll take any risk to prove I am not a coward.
4	The reason I fled is darker than my own fear.
5	I cannot commit to anything, even the service I signed up for.
6	To this day I drink to drown the screams of battle.

Forbidden knowledge

Through your diligence and intellect, you have uncovered something both eldritch and horrifying. Now the weight of this knowledge bares upon your soul and you know that the Arc is not ready.

BACKGROUNDS

d6	Trinket
1	A holo recording of something unknowable.
2	A preserved section of flesh from no known species.
3	A book written in blood on human skin found far, far from earth.
4	A set of charts that indicate a transmission on a radio-wave that is not used for communication.
5	A vial of blood, with a small unknown parasite in it.
6	An ancient clay tablet with coordinates outside the galaxy.

d6	Flaw
1	What I know makes me reckless and eager for danger.
2	I relentlessly chase any crazy rumor or insane hypothesis.
3	I will stop at nothing to keep what I know from getting out.
4	What I know has made me deeply xenophobic.
5	I believe secretive forces are after me for my knowledge.
6	Bit by bit, inch my inch, what I know is robbing me of my sanity.

Indoctrinated

The lure of some spiritual sect lead you off world and cost you your home. You have come to see them for the violent fanatics they are, and they see you as a traitor to the faith.

d6	Trinket
1	A bent holy symbol.
2	A few cones of incense.
3	An ancient, and demented, religious text.
4	An alien holy idol.
5	A holo recording of the cult leader sermonizing fanatic literature.
6	A silk sash embroidered with religious symbols.

d6	Flaw
1	I still believe some of what I was taught.
2	To this day I hate religious people, even the most moderate.
3	I murdered a high-ranking sect official.
4	I am terrified that I will be recognized and dragged back to the faith.
5	I would give anything to go home.
6	I am not confident in my decision to leave the faith and wonder if I should go back.

Kidnapped

You were taken for money, maybe your family's or corporation. In the end no one would pay, and the kidnappers had no reason to keep you alive. Whether you escaped, or the kidnappers took you in, you'll never forget the betrayal by those whom you trusted most.

d6	Trinket
1	A holo from your old life.
2	A bone from the finger they cut off.
3	Half of a broken pair of handcuffs.
4	The letter your family sent, refusing to pay your ransom.
5	The ear you took from your lead kidnapper.
6	A makeshift lockpick made from a bent hairpin.

d6	Flaw
1	I'm secretly planning to get back at my family.
2	I don't believe anyone will ever have my back, so I go it alone.
3	I believe that if you want something to happen, you have to do it yourself.
4	I am prone to panic attacks if I am badly startled.
5	I hate large crowds and will avoid them whenever I can.
6	I swore to never trust the authorities again.

Killed an innocent

You never meant to, and you can never take it back, but through your negligence, ambition, or fury you murdered an innocent. You can never replace the life you stole, and it will ever haunt you.

d6	Trinket
1	A bloodstained murder weapon.
2	A memory card with the security footage.
3	An apology letter to their family that you never sent.
4	Your victim's hospital bracelet.
5	A mysterious kerchief you victim was holding when they died.
6	A ring you took off your victim's body.

d6	Flaw
1	I have terrible screaming nightmares about the murder.
2	I don't regret it, and that scares me.
3	I want to murder again.
4	My victim's family doesn't know I did it, and they love me.
5	I am now incapable of telling the truth about anything.
6	My hands shake when I think about what I did.

Left for dead

Following a conflict or confrontation, your comrades left you for dead. Yet, despite your injuries and trauma, you lived. While your allies grieve for you, you have had a chance at a new life.

d6	Trinket
1	A card with your former best friend's comm number.
2	The bullet that almost killed you, in a tiny bottle.
3	Part of your old uniform.
4	A picture of the friend who abandoned you.
5	A bit of metal with your old ship's license number engraved on it.
6	The pin of the grenade you pulled to save your comrades.

d6	Flaw
1	I am very reluctant to trust people.
2	There's no such thing as 'No Man Left Behind.'
3	I'm secretly relieved to leave my old life behind.
4	I will never leave a man behind, even if it's suicide.
5	I want no part of my old life, despite knowing that people still mourn for me.
6	I'm secretly plotting revenge on those that abandoned me.

Lost in Space

Deep in the darkness of interstellar space you were cast away and set adrift. Lost and alone, you somehow survived against all the impossible odds. After years alone, now you have returned.

d6	Trinket
1	A knife use used to survive all alone.
2	A piece of rock with an odd crystal on it.
3	A bit of burned hull plating.
4	A set of hand-drawn charts you used to make it home.
5	A broken communication device you built yourself.
6	A holo of you and those that never made it.

d6	Flaw
1	I am terrified of the dark, and small spaces.
2	I never go into space without a long-range communication device.
3	I have no idea how to talk to people anymore.
4	I forget that I can buy what I need, and instead take things apart to build something new.
5	I talk to my computer like it's a real person.
6	I will eat anything, even if it's rotten or spoiled.

Lost Love

Tragically, and unexpectedly, you lost the one true love of your life. Perhaps they were killed or died after being married off to appease their family. Now there is a hole in your heart that will never be filled.

d6	Trinket
1	A worn photo of your love.
2	A recording device with their last words on it.
3	A braid of their hair, tied with a silk ribbon.
4	A letter, signed with a kiss.
5	The weapon used to murder your love.
6	The rings you traded on your wedding day.

d6	Flaw
1	I will never love again and won't even try.
2	I project my feelings on anyone who looks like my lost love.
3	I hate anyone who is in a happy relationship.
4	I try to fill the hole in my heart with random hook-ups and substances.
5	I'm obsessed with avenging my love.
6	I secretly think my love is still alive, and I keep looking for them.

BACKGROUNDS

Protogen Exposure

Through an impossible circumstance you found yourself exposed to Protogen technology. The experience changed you, but dark forces have become aware of you.

d6 Trinket

- 1 A strange cube that seems to always point towards a specific direction in zero-gravity.
- 2 A shard of mirror that only reflects UV light-waves.
- 3 An odd crystal that is always ice-cold to the touch.
- 4 A metallic hull-piece tarnishes black overnight if you polish it.
- 5 A bottle of black liquid that absorbs all light that touches it.
- 6 A perfectly spherical orb of exotic metal.

d6 Flaw

- 1 Whatever I saw convinced me I'm chosen.
- 2 I believe the Protogens were gods and worship them accordingly.
- 3 I believe something is following me. I see it out of the corner of my eye sometimes.
- 4 I'm dangerously obsessed with protogen technology and discoveries.
- 5 I wear dark sunglasses all the time to protect myself against 'radiation'.
- 6 I secretly believe that everything is a simulation and none of it is real.

Religious Experience

Deep in the frontier you saw something, something beyond what you can explain through science and reason. In this experience you found meaning and calling and a connection to the divine. Now you have become a devote member of your religion leaving the life you had behind.

d6 Trinket

- 1 A meticulously polished religious symbol.
- 2 A crystal with the graven image of the divine.
- 3 A tiny bottle with a holy relic within.
- 4 An ancient star chart that leads to an unknown system.
- 5 A book of prayers.
- 6 A string of ancient prayer beads that came from an alien world.

d6 Flaw

- 1 I feel the need to preach to the unconverted.
- 2 I believe my religious doctrine is greater than the law.
- 3 I will not question its matters of faith.
- 4 I am devoted to bringing my faith into Ascendancy.
- 5 I find atheists and heretic repulsive and treat them poorly.
- 6 In times of crisis I will pray instead of act.

Sold to Slavers

Wrong place, wrong time. Maybe your ship was boarded by pirates, or your colony raided by mercenaries. Your normal life was shattered, and you found yourself in the chains of bondage.

d6 Trinket

- 1 Your old slave collar.
- 2 A broken knife you used to escape.
- 3 The colors of the slavers that took you.
- 4 A single coin, hoarded for good luck.
- 5 Your old ident card from another life.
- 6 A smuggled holo of your old family.

d6 Flaw

- 1 I love food and booze and will regularly over indulge.
- 2 I hate people who keep slaves and might try to kill them.
- 3 My experiences have left me unable to sleep in a bed.
- 4 I refuse to be cuffed or restrained even if it means violence.
- 5 I tend to pocket anything that might be useful later.
- 6 Faced with capture or confinement I will flee and may even abandon my allies.

Terrible Accident

Your actions lead to a terrible accident which caused significant damage. While no formal repercussions were leveled against you, that arguably makes it worse. Now your ability is questioned as the horror of the accident hangs over you.

d6	Trinket
1	A data pad that you are constantly going over, trying to find out where you made a mistake.
2	A list of names of those lost to your failure.
3	A memory chip containing footage of your accident.
4	The official court documents, clearing your name of any wrong doing.
5	A hand written letter from a child asking you to bring their parent's back.
6	Someone's locket you found in the aftermath of the accident.

d6	Flaw
1	I secretly believe that I was set up, and that someone wanted me out of the way.
2	I can't let the incident go, so now a freeze under serious pressure.
3	I have something to prove and take unnecessary risks.
4	I'm quick to anger, and quicker to fight when someone questions my skill.
5	I've become too fond of intoxicants for my own good.
6	I'm obsessed with undoing the damage that I did, somehow.

AXIS ALIGNMENT

Almost all thinking and feeling creatures in the universe of Advent Horizon have an Axis Alignment. Your Axis Alignment broadly describes how emotionally driven versus how rationally driven you are and how you make choices and solve problems. Axis is a tool to help you understand how your character thinks. Are you a fiery Zealot that always listens to your heart, reason be damned? Or are you more contemplative and methodical, only letting your feelings intrude on your logic when it suits you?

The following are brief outlines of the eight Axis Alignments that you can select. Each describes how a being with that axis might behave. None of these are rigid rules, set in stone, and no one is perfectly exemplative of these general characterizations. Creatures with only limited intellect could still behave in a manner that is rational and calculating, whereas the most intelligent alien could be completely ruled by their emotions.

Methodical

Methodical characters are cold, calculating, and unflinching. They seem dispassionate, aloof and may lack any real empathy. One of the elements that define methodical characters is an active detachment from emotional impulse; they try not to let emotion in at all. They will always be detached and never act on emotion, even when those choices are emotional in nature. Methodical characters are never impulsive, very rarely spontaneous, and terrible at expressing their feelings.

Analytical

Analytical types think rational is very import, but they are prone to a few areas of emotionality, most likely a temper or hopeless sense of romance juxtaposed to their otherwise very critical way of thinking. Analytical characters are distant but not heartless; they can show real genuine emotion and will act on their strongest emotions from time to time. It is hard for them to be impulsive, and they prefer to have things planned out.

Reasonable

Reasonable characters are thinkers first, but also act on impulse and emotion when it suits the situation. When they do act emotionally it is usually tempered with a critical edge to keep them from going too far. Reasonable characters think things through, but can adapt on the fly, and have no trouble running with their gut and doing what they feel is right, even if it doesn't make logical sense. While they don't excel at being spontaneous, they can think on their feet, although they can get caught up in the moment too.

Passive

Passive beings tend to be just that, neither rational nor emotion takes a primary role in the character's decisions they are often very conflicted, confused, and indecisive. Passive characters have a lot of trouble acting on their own, instead letting the situation decide, or going with the most persuasive person. Big choices especially vex passive characters, who will battle with what they think versus what the feel until the scale is tipped one way or the other.

Zen

Zen is the opposite of Passive in many ways. Not every character that balances emotion and rational is indecisive, non-committal, and conflicted. A character may have, or achieve, a harmonious mind. A character that has achieved Zen can look at both their emotions and rational, and weigh that against a contemplative observation. Such beings act with sublime and

absolute confidence – no decision is ever second guessed; all actions are harmonious with the character's will and heart. Mistakes are taken in stride and never repeated, each movement is taken with firm correctness.

Passionate

Passionate creatures tend to be fiery and opinionated. Although a passionate character will act first on how they feel about things, they will temper their choices with some thought and consideration. Still how they feel and what they believe matters most. Passionate characters will also justify their feelings with rational thought, often explaining things in terms of morals, right and wrong.

Impulsive

Impulsive characters are prone to act first and think second, or never. To them their feelings and instinct matter more than all but the best reasons. To them beliefs are pivotal to their worldview and they will reject most other points of view. An impulsive character is hard to predict but easy to manipulate, they are emotional and passionate but can be reasoned with and do understand that some decisions need forethought.

Zealous

Zealous beings don't think about life, they feel it. They never really consider the situation or consequences, but go with what their heart tells them, and always unquestioningly follow their beliefs. Zealous characters don't question life or their choices ever, because what is done is done and what they feel is right regardless of the outcome, although they may not make the same mistake three times, they'll make it twice because they won't think about last time.

Unaligned

Most creatures that lack the capacity for self-reflection and intelligent thought do not have axis alignments – they are **unaligned**. Such a creature is incapable of making a moral or ethical choice and acts according to instinct and stimuli. A shark for example, has no need to weight its impulses versus its observations, and is incapable of thinking in such a way, therefore it is neither rational nor emotional – simply an instinctual animal.

The Paradox of Good and Evil

Advent Horizon takes place in a future where alien cultures and human evolution have changed the basis upon which subjective concepts such as good and evil exist. An evil person that enjoys hurting others, lying, and causing harm is extremely mentally ill. Such behavior is born from

a damaged psyche and neurological defects that can be treated and corrected. An alien culture that values life so highly that they refuse to kill or fight even in self-defense might be considered morally good even if they are willing to let billions die to maintain this pacifism.

Looking through the lens of modern philosophical understandings of the inherent subjectivity of good and evil, law and chaos, these moral and ethical constructs have been relegated to the past, to unenlightened eras.

INSPIRATION

Inspiration is awarded by the Game Master or give to you by another player when they feel you have played your character well. You might use your inspiration to bond with a potential contact over your love for books from a certain author or conjure your vengeful anger to overcome a powerful drug.

Developing Inspiration

Your GM may award inspiration for many reasons. In most cases, when you role-play the characteristics developed in your background in a compelling way, or take a dramatic action that inspires the party, you may earn inspiration at the GM's discretion. Likewise, if you have been awarded inspiration, you can give this inspiration to another player as a reward for doing something that really contributes to the game that you have enjoyed.

Inspiration is a state, not points like an ability score. Either you are in a state of inspiration or you are not, you cannot hoard inspiration, and inspiration disappears at the end of the session unless your GM explicitly rules otherwise.

Using Inspiration

When you have inspiration, you may choose to expend it to gain advantage when you make an attack roll, saving throw, or proficiency check. Once expended inspiration is lost, and you cannot give it to another player. If you give your inspiration to another player, it is likewise expended.

SECTION 06 PROFICIENCIES

A rough looking Ixaxian readies a powerful sniper rifle – his four legs make him like a mobile cannon turret. An aged Ephari studies the diplomat's face intently, while other might see sincerity, his keen eyes pierce the impeccable deception. A Seyvul twists in the near perfect zero gravity able to use rotation and breath to propel herself across the weightless corridor. In an age of science and exploration, skills and knowledge are at the center of the action. Unlike fantastic games where every character might be expected to know how to ride a horse or sharpen a sword, in Advent Horizon that is not that case.

Proficiencies are areas of knowledge and training you possess, be it in skills, tools, or languages. There are two kinds of proficiencies, core proficiencies, and specialties. Core proficiencies are general ability checks like Athletics, Perception, or Computers. Specialties are advanced areas of knowledge that you can develop once you have a core proficiency.

You can develop a core proficiency or a specialty by spending one of your proficiency slots. For example, once you are proficient in Simple Weapons, you could spend a slot to develop proficiency in ancient weapons, which unlocks even more advanced feats such as Fighting Style. Or, you could simply develop proficiency in simple guns instead.

Selecting specialties with your proficiency slots allows you to deeply customize your character's abilities and style.

PROFICIENCIES AND SPECIALTIES

Core proficiencies represents a broad area of knowledge and capacity be it weapons, armor, piloting, investigation or even sciences, and is tied to one of the six ability scores. If you developed a core proficiency, you add your proficiency bonus to those ability checks, and you unlock access to the specialties that proficiency tree.

Specialties represents an advanced skill or feat in a core proficiency tree. A Skill specialty is a normal ability check like a core proficiency, but for a specialized situation. Feats are special knowledge or techniques such as sophisticated combat maneuvers and other special abilities to set you apart.



Starting Proficiencies

You receive a selection of core proficiencies from your class and background. The number of slots you receive is determined by your class plus your Intelligence modifier. These slots can be used to develop new core proficiencies, or to advance along a proficiency tree by developing specialties.

Class	Proficiencies	Slots
Agent	Simple Weapons, Hand to Hand, Stealth, Security	14
Combat Spec	Athletics, Light Armor, Simple Guns	15
Diplomat	Bureaucracy, Insight, and Persuasion	15
Explorer	Athletics, Simple Guns, Survival, Wilderness	14
Insurgent	Simple weapons, Hand to Hand, Simple Guns, Vehicles	14
Marshal	Simple Weapons, Light Armor, Persuasion	15
Science Spec	Computers, Sciences	16
Spacer	Acrobatics, Piloting, Weapon Systems	15
Spiritualist	Intuition, Persuasion	16
Tactician	Investigation, Perception, Deception	15
Technophile	Computers, Engineering, Vehicles, Repair Kit	14

Duplicates

Should you have a core proficiency developed from multiple sources, such as developing simple guns from both your class and your background, you may instead select another core proficiency from that same ability score. These substitutions are not the same as proficiency slots and you may not use them on specialties.

Using Proficiency Slots

All proficiencies can be developed by spending one of your proficiency slots, this includes core proficiencies, specialty skills, and specialty feats. Developing a core proficiency opens a branching tree of specialties, meaning particularly advanced specialties require that you have spent one or more of your proficiency slots on the proceeding specialties. You cannot skip ahead in a proficiency tree, each specialty must be purchased in order.

Advancement

All characters receive an additional proficiency slot at levels 3, 6, 9, 12, 15, and 18. You can also trade ability score bonuses gained from levels in your class for additional specialties, each +1 you sacrifice in this way becomes one proficiency slot you may use to develop a core proficiency or specialty.

Proficient, Trained, Untrained

Proficient. If you have proficiency in a skill, specialty skill or tool, you are considered proficient and add your Proficiency and Ability Score bonuses to checks made for the proficiency.

Trained. You are considered trained in all the basic skills. When you become proficient in a basic skill, you become familiar with the specialties in this area of knowledge, and you are considered trained in them. You may make checks against trained skills, though you do not add your Proficiency bonus.

Untrained. If you don't have proficiency in a basic skill that a skill specialty appears under, any check you attempt is considered untrained. You have disadvantage on the roll with these unfamiliar specialties and may not add your ability score bonus. Now you can always attempt the roll, and there is a chance of success, but being grossly ignorant of the subject in Advent Horizon is a crippling disadvantage.

ALIEN TECHNOLOGY

Specialized systems created for one specific species, be it human, Ephari or Xhu create additional difficulty when an alien attempts to use them. This manifests as Disadvantage unless you are specifically proficient in that alien tool. The same hold true of Alien Biology, unless stated otherwise, attempting first aid or surgery on an alien whose physiology you are unfamiliar with causes you to roll skill checks with Disadvantage.

PASSIVE CHECKS

A passive check is a special kind of specialty check that doesn't involve any die rolls. Such a check can represent the average result for a task done repeatedly, such as general maintenance on a ship, attempts to gather clues searching the net, or can be used when the GM wants to secretly determine whether the characters succeed at something without rolling dice, such as critical error.

A character's total for a passive check is equal to 10 + all modifiers that normally apply to the check.

If the Character would have Advantage on the roll, add 5 to this check value. Similarly, if you would have Disadvantage, subtract 5.

Languages

Several extant languages exist in the galaxy. The Magisterium, with its long history, has an established a common tongue, now thousands of years old. Meanwhile most of the colonies speak a flavor of English that includes loanwords and terms found in almost every other earthly language. Below are the most common languages in the galaxy. But this is by no means all known forms of communication.

Ba'alur. While the Ba'alur have no global government or even unified language, the most common tribe in the galaxy is the K'ar, and as such their dialect has spread far and wide and is commonly accepted as the Ba'alur Language.

Colonial Common. The most common human language is a dialect of English collectively known as Colonial Common. Due to the influence of the corporation on the colonial efforts, a mutually understandable version of this language is spoken on almost every colonial world.

Colonial Sign Language. This is a gestural language that is directly descended from American Sign Language and was used to communicate on EVA mission by early colonists and spacers.



Ephari. The Ephari word for their language is simply "language". It is a complex melodic and tonal song that has no concept of tense, and interestingly has structural similarities to the Thothid mother tongue.

Fennish. The Seyvul language is a mixture of hoots and chirps and a tonal inflection, making it hard for Xhu and Humans to learn. Urroru and Ixaxian seem to have no trouble with it, however.

Hi'aal. This is something of an anomaly, a Xhu written alphabet found in their oldest colonies and systems. It has been suggested that this was the Xhu mother tongue. It has been noted that the structure is completely different than Magoi, and that it shares many commonalities with early earth cuneiform.

Imperial. The Language of the Imperium is based largely on English, with many loan-words from Russian and Japanese.

Magoi. Thousands of years ago the precursors of the Xhu gifted the budding magisterium with what they deemed the perfect language. Xhu and Thothid maintained this tongue as a common mode of communication with all the younger races, eventually it became known as Magoi.

Quithal. The Thothid inherited their language from some more ancient race, the harsh growling language seems ill adapted for their vocal organs. The language follows grammatical rules that seem paradoxical and requires exaggerated gestures with the tentacles to make the points of tense and subject, something non-Thothid must mimic with their hands.

Uxian. Spoken by the Ixaxians, Uxian is a language with tremendous information density, made up of chirps, clicks, and pops. Most words in Uxian are complex meme-forms that compound to convey bulk information.

SKILLS

The following skills are available to all characters. Once you are proficient in a skill you can use your proficiency slots to select the specialty skills and feats that fall under that skill tree. Each skill or feat consumes one of your proficiency slots.

Specialty skills and feat often have required prerequisites, and you must first use a proficiency slot to gain these before you can move along that skill like. For example, before you can learn the Take Fall feat, you must have the Climbing skills.

Each core proficiency includes a diagram of the prerequisite skills or feats fore each of teh more advanced abilities.

Strength



Athletics

With proficiency in athletics you have the kind of general athletic ability born from regular exercise, playing athletic sports and lifting weights. You add your proficiency bonus to strength checks involving while climbing, jumping, swimming and so on.

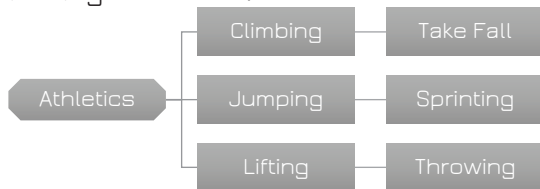

Climbing [Skill]

On a successful climbing check against DC 15 you can move your full speed up a surface for one round, as well as add your proficiency bonus to climbing checks made to move at half speed up difficult surfaces. With this proficiency you can also jump from climbing positions.

Jumping [Skill]

You can make impressive leaps, long jumps and standing jumps. Every 1 meter beyond your strength score in length adds 5 to the DC to make a long jump. You can high jump an additional 0.35 meters per 5 added to the DC of the jumping check.

Lifting [Skill]

You may attempt to dead lift extreme weight. On a DC 10 Lifting check you may lift 20 times your strength score in Kilograms. Each additional multiple of your strength score increases the DC by 1. So, to dead lift 30 times your strength score would require a DC 20 Lifting check.

Sprinting [Feat]

You are adept at moving in quick bursts. Your combat movement speed is increased by +3 meters per round. This feat does not affect your overland travel speeds.

Take Fall [Feat]

As an action, you may roll following a fall. This allows you to negate 1D10 + Level falling damage. If you take no damage you are not prone following the fall.

Throwing [Skill]

You are proficient in throwing non-weapon objects, such as balls, stones, discus, or other oddly shaped forms.

Simple Weapons

With this Skill you have basic combat ability and are proficiency in the use of simple melee weapons such as a club, stun-gun, or knife.

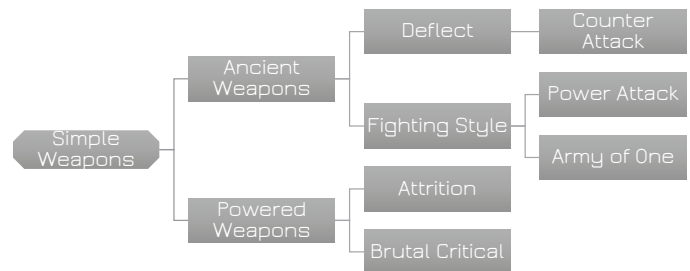

Ancient Weapon Proficiency [Skill]

You may select this specialty multiple times. Each Time you select this specialty you may choose four ancient melee weapons with which you are proficient.

Army of One [Feat]

Armed with an ancient melee weapon you are never outnumbered. When faced with at least 3 opponents, once on each of your turns you may make an extra attack against an opponent within 2 meters of you using your ancient weapon. If you are faced with fewer than three enemies, or you are not armed with an ancient weapon with which you are proficient you may not make this extra attack.

Attrition [Feat]

You've become an expert in using powered weapons to wear down powerful foes. Once each turn you may add 1d8 damage to a successful

attack action with a powered weapon against any enemy below maximum hit points.

Brutal Critical [Feat]

Armed with a powered melee weapon, your weapon attacks score a critical hit on a 19 or 20.

Counter Attack [Feat]

If you are attacked by an adjacent creature within reach you may attempt to use your reaction to counter attack with a melee weapon in hand. If you miss this attack, your target may make an opportunity attack against you.

Deflect [Skill]

While Armed with a melee weapon you may attempt to use your reaction to intercept another melee weapon attack. The DC to intercept a blow is set by the attack roll of the opponent. On a successful Deflect check, you roll your weapon damage, and reduce the damage you receive from the attack by this much.

Fighting Style [Feat]

You may select this feat specialty multiple times, each time you do you must select a different Fighting Style from the list below.

Defense. While you are wearing ancient armor and armed with an ancient weapon, you gain a +1 bonus to AC.

Dueling. When you are wielding a melee weapon in one hand and no other weapons, you gain a +2 bonus to damage rolls with that weapon.

Great Weapon Fighting. When you roll a 1 or 2 on a damage die for an attack you make with a melee weapon that you are wielding with two hands, you can reroll the die and must use the new roll, even if the new roll is a 1 or a 2. The weapon must have the two-handed or versatile property for you to gain this benefit.

Protection. When a creature you can see attacks a target other than you that is within 2 meters of you, you may use your reaction to impose disadvantage on the attack roll. You must have a shield in hand to use this feat.

Two-Weapon Fighting. When you engage in two-weapon fighting, you can add your ability modifier to the damage of the second attack.

Power Attack [Feat]

Before you roll for a melee attack with an ancient weapon, you may declare this feat. Rather than add your proficiency bonus to your attack roll, you instead add this bonus to damage. If the weapon has the finesse trait, you must use your strength modifier, not dexterity.

Powered Weapon Proficiency [Skill]

You may select this specialty multiple times. Each Time you select this specialty you may

choose four powered melee weapons with which you are proficient.

Light Armor

You are proficient in the use of light protective armor and you may add your proficiency bonus to your Armor Class to determine your Armor Rank. You do not suffer any skill check penalties while wearing Light Armor.

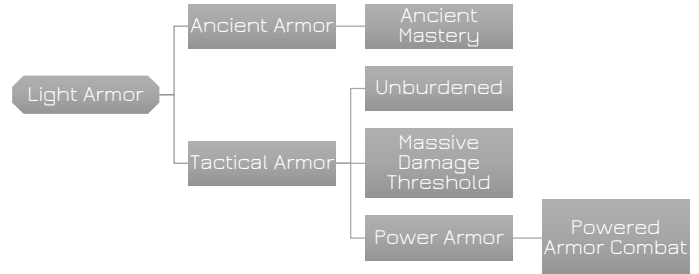

Ancient Armor Proficiency [Skill]

You are proficient in the use of medium and heavy ancient armors. You may add your proficiency bonus to your Armor Class to determine your Armor Rank. While wearing ancient armor you do not suffer any skill penalties.

Ancient Mastery [Feat]

Ancient Armor is often ineffective against modern firearms and energy weapons, however bludgeoning, piercing, and slashing damage that you take while wearing ancient armor is reduced by 3.

Power Armor Piloting [Skill]

You are proficient in the use of powered exoskeletal armor. You may add your proficiency bonus to your Armor Class to determine your Armor Rank. You receive all ability score benefits from a suit of powered armor.

Power Armor Combat [Feat]

With this feat, you may use your Power Armor Operations skill to make proficient unarmed attacks or attacks with integrated weapons systems such as built in energy beams or micro-missiles.

Tactical Armor Proficiency [Skill]

You are proficient in medium and heavy tactical armors and you may add your proficiency bonus to your Armor Class to determine your Armor Rank. You do not suffer any skill check penalties while wearing Tactical Armor.

Unburdened [Feat]

With this feat, you do not count the weight of tactical armors you are wearing towards your encumbrance.

Massive Damage Threshold [Feat]

Tactical armor is designed to absorb the brunt of damage from high powered attacks such as

PROFICIENCIES

firearms and energy weapons. With this feat, you are better able to survive otherwise lethal damage of modern weapons. Anytime you take damage that would reduce you below 0 hit points, all damage that would carry over past 0 is halved.

Hand to Hand Combat

With this skill you are proficient in unarmed attacks. On a hit, an unarmed strike deals bludgeoning damage equal to 1+ your Strength modifier.

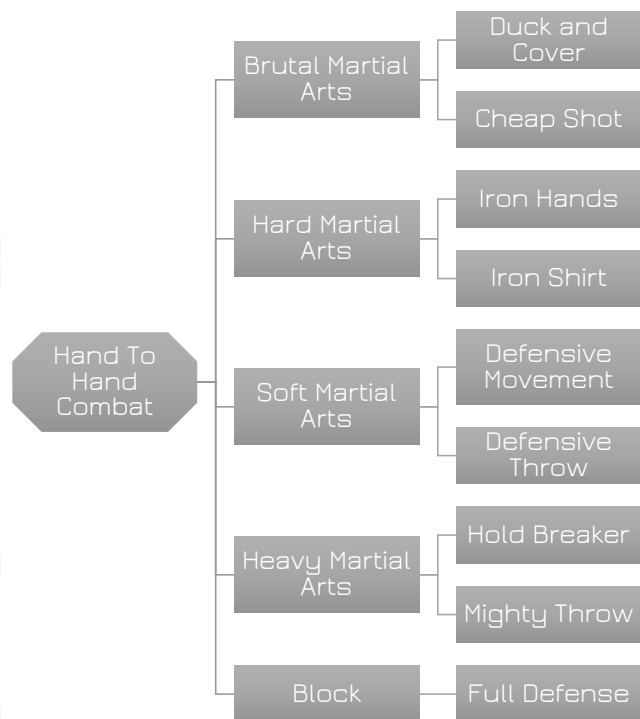

Brutal Martial Arts [Skill]

You are proficient in Grappling. When you take an unarmed attack action on your turn, you may make one extra unarmed attack as a bonus action, using a hand or foot. You may only take one bonus action per turn.

Cheap Shot [Feat]

If you initiate combat with an unarmed attack action, this attack action will score a critical on an 18 - 20. This could combine with any other bonuses, such as attacking an unaware target for example.

Defensive Movement [Feat]

While you are unencumbered, you may add your Wisdom modifier to your armor class against melee attacks.

Defensive Throw [Feat]

If you are the target to a grapple attack or shove attack, you may use Soft unarmed attack skill to counter this attack. If you successfully defend against the grapple or shove you may

use your reaction to throw the attacker, knocking them prone and dealing 1d4 + Dexterity Modifier damage.

Block [Skill]

While you are unarmed you may attempt to use your reaction to intercept another unarmed attack. The DC to intercept a blow is set by the attack roll of the opponent. On a successful Deflect check, you roll your Unarmed damage, and reduce the damage you receive from the attack by this much.

Duck and Cover [Feat]

When you take a Dodge action, you gain the full benefits even against unseen ranged attackers so long as you are aware that you are under attack. For you, three-quarters cover is considered full cover.

Full Defense [Feat]

When you declare a dodge action, you may choose to add your proficiency bonus to your armor class. You may not defensive reactions in a round that you use this feat.

Hard Martial Arts [Skill]

Your unarmed attack damage is 1d4 + Strength modifier. When you take an unarmed attack action on your turn, you may make one extra unarmed attack as a bonus action, using a hand or foot. You may only take one bonus action per turn.

Heavy Martial Arts [Skill]

You can use Constitution instead of Strength for the attack and damage rolls of your unarmed strikes. You are Proficient in Shoving attacks.

Hold Breaker [Feat]

When you use your Heavy Unarmed Attack proficiency to counter a grapple or shove attempt you receive Advantage. If you successfully prevent a hold or a shove, you may use your reaction to make an unarmed attack action against the attacker who attempted to grapple or shove you.

Iron Hands [Feat]

You can deliver incredibly lethal blows with your unarmed attacks. Your unarmed attack damage is 1d4. At 6th level, this increases to 1d6, and again to 1d8 at 11th level. At 17th level your unarmed attacks deal 1d10 damage.

Iron Shirt [Feat]

When struck by a bludgeoning attack, once per round you may use your reaction to instantly negate 1d10 + Strength Modifier + Level damage from the attack. You may only use this ability if you are unarmored.

Mighty Throw [Feat]

If you succeed a Shove attack against a target, you may instead throw the victim. The target is knocked Prone and takes 1d6 + Strength Modifier + Level damage from this throw.

Soft Martial Arts [Skill]

You can use Dexterity instead of Strength for the attack and damage rolls of your unarmed strikes. When you use the attack action with an unarmed strike on your turn, you can make one unarmed strike as a bonus action. You may only take one bonus action per turn.

Dexterity

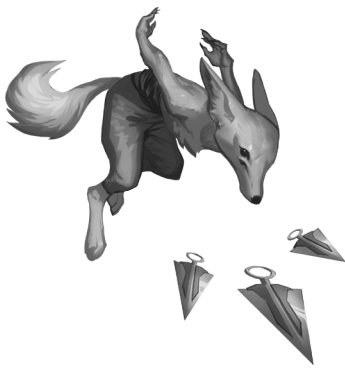

Acrobatics

You are proficient in your attempt to stay on your feet in a tricky situation, such as running across narrow railing or rolling under a closing door. To see if you can perform acrobatic stunts, including

dives, rolls, somersaults, and flips the GM might call for a check against this skill.

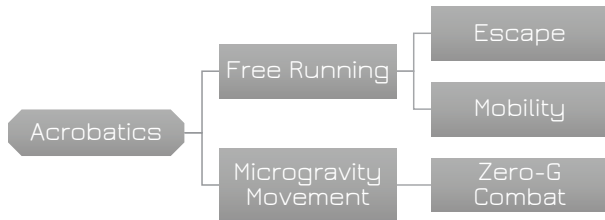

Escape [Feat]

Because of your ability to move through your environment with ease, opportunity attacks against you are made with disadvantage.

Free Running [Skill]

With this Feat, when you take a Dash action, you are unhindered by difficult terrain.

Microgravity Movement [Skill]

In situations without gravity, this skill replaces classical acrobatics checks.

Mobility [Feat]

With this feat you may use a bonus action at the end of your turn to take the dodge or disengage action.

Zero-G Combat [Feat]

With this feat you are not at disadvantage while fighting in micro gravity.

Archery

You are proficient in the use of bow and arrow. You may make use of short, long, recurve and compound bows with proficiency.

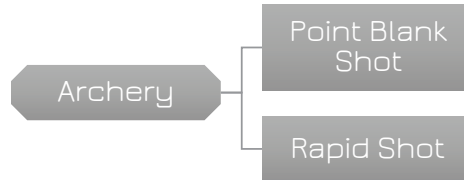

Point Blank Shot [Feat]

You are skilled in the use of bows or crossbows in close range. With this feat you gain a +1 bonus on attack and damage rolls with these weapons when used within 10m of your target.

Rapid Shot [Feat]

Provided you have the ammunition, once you have made a bow attack action on your turn you may take a bonus action to attack with your bow again at the same target.

Piloting

You are proficient in piloting spacecraft with semi-autonomous controls in the vacuum of space. While you can pilot most standard spaceships, you lack the specialized skill necessary to perform atmospheric flight, combat maneuvers, or take the helm of Capitol Ship.



Advanced Piloting [Skill]

Armed with this specialty you can skillfully pilot advanced ships with sophisticated multi-system helms as well as pilot subsonic aircraft and perform planetary entry and landing.

Combat Maneuvers [Feat]

You know how to fly in a fight. Add your Proficiency bonus to your ships armor class while you are at the helm.

Capitol Piloting [Skill]

Manually piloting the massive capitol ships of the galaxy requires a level of understanding of the forces at work on these massive vessels. You are able to pilot these huge ships with proficiency.

PROFICIENCIES

Elite Piloting [Skill]

Piloting ultrafast fighters and super complex gunships requires extreme training and the ability to react in an instant to multiple separate systems. You have undergone some of the most grueling piloting and technical training. You can pilot elite level ships, such as fighters, and stealth gunships.

Simple Guns

You are proficient in the use of simple firearms and ranged weapons such as hand crossbows, semi-automatic pistols and energy pistols.

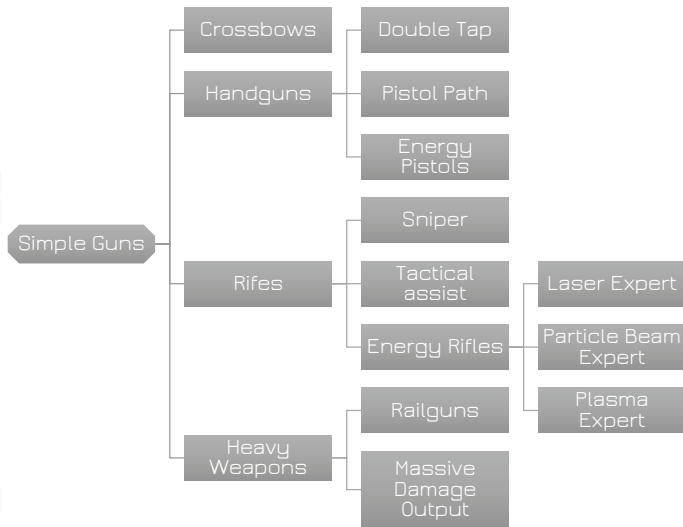

Crossbows Weapon Proficiency [Skill]

Still in use in the distant future, you are proficient in the use of light and heavy crossbows.

Double Tap [Feat]

When you make an attack action with a handgun, you may immediately take a bonus attack action against the same target.

Energy Pistol Weapon Proficiency [Skill]

You are proficient in the use of high output energy handguns.

Energy Rifle Weapon Proficiency [Skill]

You are proficient in the larger and very dangerous high output energy rifles.

Handgun Weapon Proficiency [Skill]

You have proficiency with modern handguns such as revolvers, semiautomatic pistols and machine pistols.

Laser Expert [Feat]

When using laser or pulse weapons you gave a +1 to rolls to hit due to their precision and accuracy.

Particle Beam Expert [Feat]

The most devastating type of energy weapon, particle beams have shocking lethality. When you score critical hit with a particle beam weapon you add an additional damage dice.

Pistol Path [Feat]

While fighting in melee combat, you no longer have Disadvantage on attacks with handguns.

Plasma Expert [Feat]

Plasma and Ions weapons may lack the penetration value of mass drivers, but you can leverage their devastating energy to cause considerable damage. You score a critical on rolls of 19 or 20 with these weapons.

Rifle Weapon Proficiency [Skill]

You are proficient in breach loading rifles, assault rifles, and shotguns as well as EM accelerated mass drivers such as light railguns and coil guns.

Sniper [Feat]

This feat makes you an expert at taking shots at extreme range. For you, the normal long range of a rifle is doubled.

Tactical Assist [Feat]

You may use your Action to provide Tactical Aid (see combat) to one of your comrade's attack rolls against a creature that is within the range of your weapon with suppressing fire.

Heavy Weapons [Skill]

You are proficient with all manner of extremely heavy weapons such as grenade launchers, rockets, Gatling guns, machine guns, and missile launchers.

Rail Guns [Skill]

Heavy electromagnetic mass drivers, rail guns operate someplace between energy weapons and rifles. You are proficient in these huge and devastating weapons.

Massive Damage Output [Feat]

Heavy weapons are exceedingly lethal in your hands. Any time you deal damage with a heavy weapon to a target which would reduce the target to less than 0 hit points, all damage below 0 is doubled. For example, if you scored a hit with a rocket launcher which dealt 30 damage to a target with 20 hit points, they would be reduced to 0 HP and the remaining damage would be doubled, reducing them to -20, and instantly killing the target.

Sleight of Hand

Also known as prestidigitation or palming, you can perform a number of feats with this skill. In addition to tricks and entertainment, you can use this skill to cheat, conceal objects in the hands, and even lift (steal) objects on other creatures. Because there are so many applications of this skill, the DC becomes the difficulty for others to notice your legerdemain with a Wisdom (perception) check.

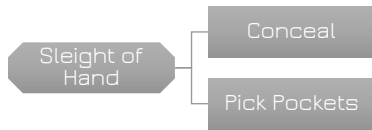

Conceal [Feat]

This feat allows you to keep a small item hidden in your hands under close scrutiny by constantly moving it and maintaining it out of the observer's vision. You have advantage on Sleight of Hand checks made to hold an object no larger than 1 kg while ensuring that it is invisible to observers.

Pickpockets [Feat]

Prestidigitation allows you to easily lift small items from other, or plant small items on them. This is resolved like a melee attack roll, ignoring armor. On a "hit" with prestidigitation you can take or plant items completely unnoticed.

Stealth

With this skill you are proficient in moving quietly and remaining unseen. The DC to hide is 10, the DC to notice you is equal to your Stealth check. While prowling you can only move at half of your normal speed.

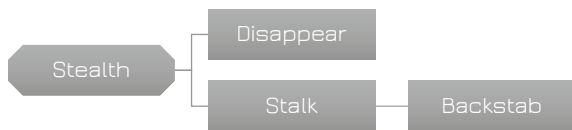

Backstab [Feat]

Using Stalk, you gain one additional dice of damage at levels 6, 12, and 18 when you succeed a sneak attack.

Disappear [Feat]

With this feat you may take a Hide action to roll a prowl check and vanish from the sight of one creature. On your next attack you are considered hidden.

Stalk [Feat]

With this feat you can attempt to enter melee range with a target without being seen by carefully tracking their sightlines and motion. If you attack from an unseen position you have Advantage on the attack roll, and deal one additional damage dice with your attack.

Weapons Systems

This covers interstellar battleships, space stations or similar weapons systems. If you have proficiency in this skill you are proficient in targeting semi-guided or targeting shipboard weapons, missiles, guidance systems, drones, as well as radar and ballistic countermeasures such as flack, spray, and anti-missile systems.

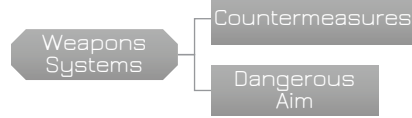

Countermeasures [Skill]

You are proficient in countermeasures and shielding systems, and may use your reaction in ship to ship combat to attempt to intercept attacks with countermeasures.

Dangerous Aim [Feat]

You are not at disadvantage when targeting specific ship's systems in ship to ship combat.

Constitution

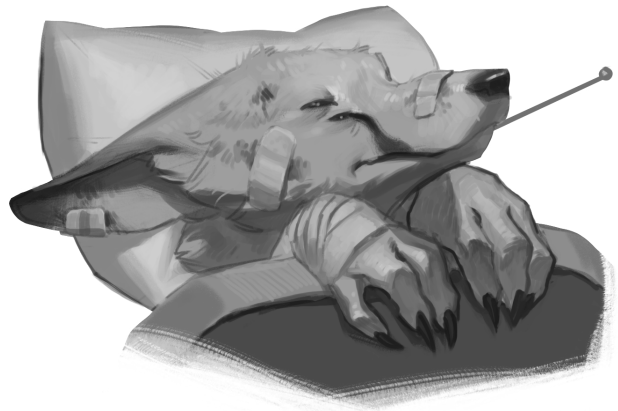

Endurance

This skill represents your will to live, such as marching, resisting fatigue and resisting suffocation. If you have proficiency in this skill you add proficiency bonus to Death Saving throws!

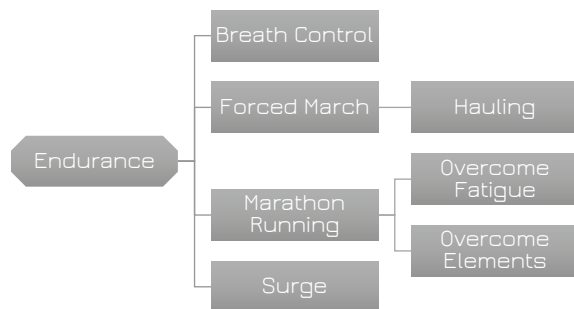

PROFICIENCIES

Breath Control [Skill]

By carefully controlling your heartrate and movement you can greatly prolong how long you are able to hold your breath. Each minute beyond your usual limit (1 + Constitution Modifier) you may roll a Breath Control check. The DC is 10 + 1 per minute above your normal limit. If you fail a check, you immediately begin suffocating.

Forced March [Skill]

You are proficient in marching long hours and may make a forced march check after 8 hours with your proficiency bonus with this skill.

Hauling [Feat]

You've trained in wearing and moving with your full pack and have grown accustomed to keeping pace encumbered. While you are encumbered (but not heavily encumbered) you do not suffer a movement speed penalty.

Marathon Running [Skill]

With a successful Marathon Running check you may increase your travel speed by one half while traveling overland. The DC is 10, +1 each additional hour. After the first hour, a failed check results in one level of Exhaustion. If you choose to travel over land for more than 8 hours in a day, you may make a Marathon Running check each hour.

Overcome Fatigue [Feat]

Your conditioning training allows you to overcome fatigue with an Endurance check. The DC to overcome fatigue is 10 + 5 for each current level of fatigue. If you succeed this check you recover one level. Once you have used this ability you must complete a short or long rest before you may use it again.

Overcome Elements [Feat]

If you failed a saving throw against extreme heat or cold, you may attempt an Endurance skill check on your turn to overcome the effects of the adverse elements until your next rest.

Surge [Feat]

Beyond the limits of lesser men, you stand strong. On your turn, you can use a bonus action to regain hit points equal to 1d10 + your fighter level. Once you use this feat, you must finish a short or long rest before you can use it again.

Survival

You have a reasonable knowledge of flora and fauna, including identifying edible plants, preparing animals, and fashioning weapons from crude materials. With this skill you can forage and hunt for food and collect clean water in a biome where they are available. The DC is 10 in a familiar biome, 15 in an unfamiliar Biome, and 20 in a hostile alien Biome.

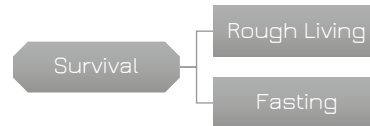

Rough Living [Feat]

You can maintain a Comfortable lifestyle with zero cost in a familiar biome by living off the land.

Fasting [Skill]

You can survive prolonged periods without food before noticing ill effects. Each day beyond your normal limit of 3 + Constitution modifier days, you may make a Fasting Check. The DC is 15, +5 each successive day. If you succeed you can last that day without food, and do not suffer exhaustion. You still require water.

Intelligence



Bureaucracy

You can navigate the complexities or red-tape and middle-management and government. You have firsthand experience doing the paperwork in triplicate to get things done. This can be particularly useful on large stations or developed planets where know who to talk to and what to file can mean life or death to your crew.



Negotiation [Skill]

You can structure deals in such a way as to meet agreeable terms and beneficial outcomes. As a practical use of this skill when buying or selling volume items or services you can potentially increase or decrease the price by 10% based on a successful skill check.

Pass the Buck [Feat]

As middle management you excelled at passing the responsibility to, well, anyone else. If you roll a critical failure on any interpersonal Intelligence or Charisma skill, you can instead succeed at the cost of passing the repercussions of that failure on to one of your comrades. You can use this feat once per short rest.

Law [Skill]

The practice of law varies from world to world. Most of the colonies adopted systems of law and court not unlike the 21st century, while the Imperium and the Magisterium have Tribunals and complex Hearings. You are able to practice in the courts, are aware of the process, submitting evidence, and making a persuasive case by citing precedents. With this skill you can also decipher complicated legal documents such as legislation, laws, or contracts as well as construct the above to provides the most favorable interpretation for yourself. You are familiar with the general legal precedents of most of the galaxy and can quickly ascertain local laws from legal documents.

Computers

A computers check allows you to load and execute application and use those applications to solve novel problems. Computers can be used to augment or support any number of skills, which makes them exceptionally powerful and useful. Mathematics, research, arts, all these can be aided with the use of computers granting Advantage on those rolls. Provided sufficient network access, a character can use computers to locate the steps to accomplish virtually any civilian task.



Hacking [Feat]

With this feat you can make use of computer programming principles to exploit vulnerabilities in secured systems to gain access to, and potentially change, data. The specific DC is set by the security of the system.

Jamming [Feat]

Using Communication systems or specific jamming systems you can attempt to make communications in the local area difficult. Attempting to get communication past your jamming requires a roll with a DC equal to or greater than your Communication Systems roll.

Programing [Skill]

A character with this specialty can craft computer applications and has a solid understanding of the function of computer programs and computers in general. The DC to create a program depends largely on the solution needed and the environment.

Technical Operations [Skill]

You are proficient in the advanced operation of ship and station sensor and communications systems. Using sensors systems able to detect, identify, and extract information as described under Perception and Investigation skills. If you are actively monitoring sensors your passive skill can be used to detect stealth ships. You are proficient in the use of communication transmission and receival systems, including radio, systems networking, and Q-Bit communication processes. Generally, a check is called for to overcome or by-pass jamming.

History

You are very knowledgeable about galactic history. A successful check allows you to accurately recall establish lore regarding specific historical places, events, cultures and conflicts.

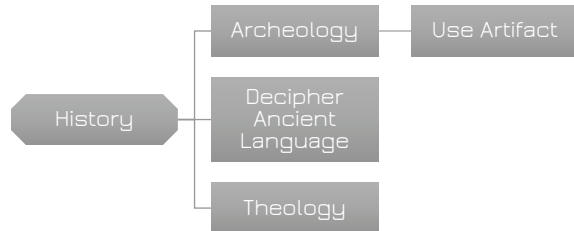

PROFICIENCIES

Archeology [Skill]

You have made a study of the ancient origins of civilization, their culture, and their technology. You can place the general period of ancient structures, tools, and artifacts. You can also attempt to identify protogen artifacts.

Decipher Ancient language [Skill]

Armed with an understanding of ancient languages and scripts, you can attempt to decipher ancient or dead written languages. Unlike simply taking a language specialty, this specialty allows the character to read a number of ancient languages, but only in the most basic and literal sense, this is why it is deciphering. As these languages are dead, the meaning of colloquialism, poetry, and metaphor is hard to grasp without any social context. With this specialty that character can piece these things back together as well as reasonably read the ancient script.

Theology [Skill]

The study of the ministerial aspects of a religion: its values, rules, and history, Theology is the contemporary knowledge necessary for someone trained in religious practices. This is more focused on established religions with a breadth of history and writing but could be applied to other faiths as well. You might be called to make a theology check to identify religious texts, artifacts, or holy litanies and prayers.

Use Artifact [Feat]

With this feat, you have learned much of Protogen technology and are able to make use of their strange artifacts with proficiency.

Investigation

You can closely examine a scene or environment to gain relevant information about the situation, or events that have occurred, or evidence of those events. This could include finding hidden compartments or doors, gathering evidence of a crime, or identifying a forgery or fake.

Investigation

Information Extraction

Information Extraction [Skill]

Interrogation is very rarely about torture or threats, it's about patience, repetition, and wit. You are trained in the kind of spy craft style interrogation used to extract information from assets without them even being aware they are being interrogated. Once you have engaged the target, an Information Extraction action can be attempted each round.

Engineering

This proficiency measures your understanding of electromechanical engineering. With an engineering check you can identify damage to a system, where a ship's weak point might be, or the make and manufacture of a tool.

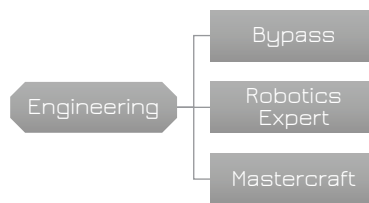

Bypass [Skill]

This is the art of tricking or disabling electronic locking or activation systems into opening, or not opening in some cases, by physically tampering with the system. You are proficient in physically bypassing most electronic security locks provided the tools.

Mastercraft [Feat]

You can spend time, money, and experience to build novel and superior devices which provide a bonus, from +1 to +3. For more information on mastercrafting, see section 12.

Robotics Expert [Feat]

When using electrical engineer or mechanical engineer to build robotic systems - power armor, drones, and autonomous robots - you need only spend half the time constructing the device. Using Repair Kits on robots you can restore 2d6 damage to the machine per level.

Sciences

A sciences check will inform you about energy, geology, cosmic phenomena, and generally any other situation where the scientific method might apply, such as identifying unknown materials, analyzing sensor readings, or performing complex mathematics.

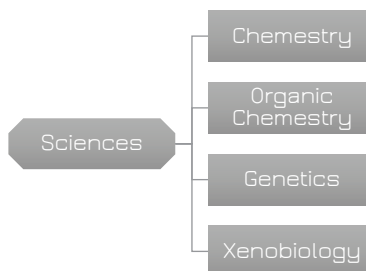

Chemistry [Skill]

With this skill you have advanced knowledge of chemical and physical reactions from the atom up, and can use a laboratory to produce, alter or examine complex chemicals, and potentially invent new materials. You can readily create most acids and bases as well as powerful explosives.

Mathemagical [Feat]

This feat allows you to combine your mathematic understanding with piloting and weapons systems giving you Advantage on those skill checks!

Genetics [Skill]

This skill is an advance knowledge of genetics and epigenetics. With proficiency in this specialty this character may use a laboratory to research, identify, and potentially modify organisms on the genetic level. The exact scope of what the player can accomplish is largely dependent on their resources, time, and the GM.

Organic Chemistry [Skill]

A character with the Organic Chemistry skill may use a laboratory to research, develop, and explore bio-chemicals. This includes developing new pharmaceutical compounds, identifying compounds, toxins, and poisons, and working with biological samples. You can readily synthesize anti-toxins and antidotes, as well as most drugs.

Xenobiology [Feat]

This character is well versed in the biology of several alien creatures, including all player species. They do not incur the usual Disadvantage for dealing with alien biology.

Wilderness

This skill covers your ability to recall or obtain information about terrain, natural plants and animals, the weather, and seasons. On new and alien worlds you can use your knowledge of similar worlds to deduce this information.



Land's Stride [Feat]

You are not hindered by natural foliage and hazardous plants. You are unhindered by difficult terrain caused by natural plant life, foliage, and vegetation.

Weather Sense [Skill]

With a DC 15 Wilderness check you can predict naturally occurring weather phenomena in your general vicinity with 1d4 hours of advance. Phenomena such as storms, precipitation, sudden heat or cool winds, or clearing weather will be predicted. You cannot foresee other natural disasters or events such as earthquakes, volcanos, or meteor showers.

Predator's Grace [Feat]

You have advantage on Stealth checks made in natural difficult terrain.

Wisdom



Animal Handling

You can use this skill you manage and control trained animals, such as riding a horse or other creature, or hunting with a hawk. The complexity of the commands or the situational challenge will set the DC to control the animal.



Nature's Grace

With this feat, any natural non-predatory animal will not see you as a threat. Animals being creatures that are not artificial organisms, with an Intelligence score of 3 or less, and are not predators. Such creatures will respond to your presence as if you were another herbivore or omnivore that poses no threat, though they may not want to be touched or let you ride them, they will not flee in your approach. Birds will land on you; deer and similar creature will ignore your company and so on. This effect ends immediately for all animals in 60 meters if you attack any creature.

PROFICIENCIES

Animal Training [Skill]

With this you can break and subsequently train an animal. With a domestic animal, you must succeed a training check each day, and spend 1 day working with the animal plus their Wisdom Modifier. Wild animals take twice as long. After three failed attempts, consecutive or not, the animal becomes despondent (and potentially hostile) to you and cannot be trained by you. The DC is 15 for domestic animals, and 20 for wild animals.

Animal Companion [Feat]

You may forge a unique bond with an animal. You may train one animal with an Intelligence score of at least 4 and no more than 7, to be your animal companion. The animal can be no larger than Large and that has a challenge rating 1 or lower. Add your proficiency bonus to the beast's AC, attack rolls, and damage rolls, as well as to any saving throws and skills it is proficient in. Its hit point maximum equals its normal maximum or four times your ranger level, whichever is higher.

The beast obeys your commands as best as it can. It takes a turn on your initiative, though it doesn't take an action unless you command it to. On your turn, you can verbally command the beast where to move (no action required by you). You can use your action to verbally command it to take the Attack, Dash, Disengage, Dodge, or Aid action. If you have the Extra Attack feature, you can make one weapon attack yourself when you command the beast to take the Attack action.

If your companion dies, you must wait until you gain a level before you can attempt to forge this unique bond with an animal you have successfully trained.

Medicine

With this skill you can provide immediate medical care to critical patients. You know how to forestall death due to heart attack, stroke, choking and drowning. You can set bones and apply crude splints. You can stabilize a dying creature on a DC 15 check. You have a limited capacity to diagnose common illnesses and injuries.



Treat Injury [Feat]

You know how to treat serious wounds and injuries. You can use basic medical supplies to restore two hit dice of hit points to a wounded creature on your turn. A creature may be healed in this way once per short rest.

Medical Diagnosis [Skill]

With this you can exercise your medical understanding to identify the symptoms and expressions of illness, infection, and injury through reason, observation, and logic. The DC to diagnose depends on the specific condition. With a successful diagnosis, you have advantage on any check to treat an ailment or at least know what treatment is called for, be it a drug regimen, rest, or surgery.

Surgeon [Skill]

You have the training and medical skills to perform invasive surgery without killing the patient. You are proficient working in an open patient, know how to cut to minimize blood loss and scaring, and how to suture and mend wounds. This also includes treating injuries such as shrapnel or gun shots or excising malignant tissue or invasive organisms. On a successful Surgeon roll you can revive a patient that has failed all saving throws vs death in the last five minutes (DC 15). You can also implant cybernetics and cyber systems. On a failed surgery roll, the patient needs to roll a death saving throw, or die.

Insight

Using your intuition and understanding you can get a read on people with little or no information. This is not cold reading, but more of an empathic understanding. With this skill you can determine the true intentions of a creature, such as when if they are being dishonest or if they are hostile, but feigning civility, by gleaning clues from body language, speech habits, and changes in mannerisms.

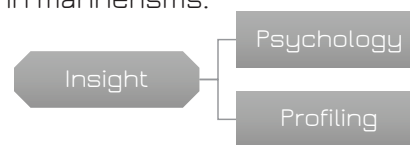

Psychology and Psychotherapy [Skill]

You can understand, diagnose, and treat mental illnesses, trauma, and anxiety with this skill. In practical terms, by engaging in regular therapy, a creature with antipathy can attempt to lower their antipathy score with your aid. A successful therapy session requires you to make a check. If you are working to help resolve antipathy the DC is 10 + target's Antipathy score.

Profiling [Feat]

You can use small amounts of information to gain insight into the patterns of a target. Profiling is it used for predictive analysis, psychology, and understanding suspicious behavior. You gain advantage on Insight checks to predict the target's next action, as well as determine their class levels, if any, and axis.

Intuition

An intuition check rates your connection to the larger universe as well as your ability to perceive things that are at the edge of scientific ability to explain. You might be called upon to make a Wisdom (intuition) check when you attempt to get a gut feeling about something, detect the influences of psionic phenomena, or interface with protogen technology.

Intuition

Meditation

Meditation [Skill]

While meditation takes many forms, this skill is the act of calming the mind and regaining focus. Meditation has several applications: By meditating for 10 minutes you can gain the same effect as a short rest (DC 15). It takes one solid round of concentration to enter a meditative state and doing so allows you to attempt to recover from Anxiety, Charmed, Frightened, or Provoked conditions. The DC would be set by the original save.

Perception

Sometimes called situational awareness, you can notice details in your environment that might otherwise elude the less observant. For example, you might observe that you are being tailed in a busy station mall, or that an otherwise friendly stranger has a concealed weapon. In the case where you are attempting to notice another's activity, a contested roll is called for, be it stealth, sleight of hand, or some other relevant skill.

Perception

Bodhi

Danger Sense

Bodhi [Feat]

You can enter a meditative state of awareness - the origin of this word. This take one complete round of concentration at the end of which you become extremely aware of your environment, body, and moment. In this state you cannot be surprised, and unseen attackers do not gain Advantage against you. You can maintain this state for 1 + Wisdom Modifier rounds.

Danger Sense [Feat]

You have a keen sense of self preservation. You can detect potential harm from traps or unsafe environmental situations. Your passive Perception check allows you to detect potential harm or danger from traps, unsafe paths, unstable materials, or dangerous situations automatically. Most traps have a specific DC to detect them, environmental hazards are up to the GM to set.

Charisma



Deception

Lying well, and believing those lies is the heart of deception. There are several flavors of lies, all of them hinge on speaking to another untruthfully, in part or in whole. You are adept at fabricating truth, and keeping these fabrications straight in your mind, as well as engineering smaller simple lies, polite lies, and perjury. An Insight check to detect and overcome a lie with no other evidence is set by the liar's roll.

Deception

Manipulation

Demoralize

Sinister Suggestion

Feint

Invisible Strike

Obfuscation

Feint [Feat]

With this feat, any attempt to use insight to determine your action or intent in combat is done so with disadvantage.

Invisible Strike [Feat]

Choose a target. You may use Deception as a bonus action before you attack this target, moving in such a way that you deliver an unseen attack. You gain advantage on your next attack role and it is considered an attack from hiding.

Obfuscation [Skill]

Lies of omission and truth are the worst. With this feat any attempt to use insight to detect your lies and dishonestly is made with disadvantage during interactions and non-combat situations.

Demoralize [Feat]

You can crush the will of your enemies through cutting words and your menacing presence. To do so, you use your action to choose one creature other than yourself you who can hear you.

You can reduce one ability check, attack roll, skill check, or saving throw it makes on its next turn by 1d8. You can wait until after the target rolls the d20 before deciding to use demoralize but must decide before the GM says whether the roll succeeds or fails.

You can use this feat a number of times equal to your Charisma modifier (a minimum of once). You regain any expended uses when you finish a long rest.

Manipulation [Skill]

You can exploit cognitive biases, preconceptions, and psychological faults to manipulate and control people. For example, using the Barnum effect, broad generalizations and vague questions, to glean information from a target and convince them of a deep connection.

When you make a Manipulation check against a target, they are entitled to a contested Insight or intelligence check. Should they fail, your deceptions are impossible for them to detect until they complete a long rest.

Sinister Suggestion [Feat]

Using a combination of all of the methods above, you can plant a sinister suggestion in a target which can sabotage them. It takes 1 minute + the target's Wisdom modifier to plan this idea.

Depending on the nature of your suggestion you might be able to cause the target to suffer from the effects of Anxiety, Frightened, or Charmed conditions, or Provoked condition at a target of your choosing.

If the target possesses any Issues from an Antipathy Score, you can attempt to cause them to experience and episode. Regardless, at the end of the time you spend speaking with the target they must succeed a Wisdom Saving Throw against $8 + \text{Proficiency Bonus} + \text{your Charisma Modifier}$ or succumb to your suggestion.

Intimidation

Intimidation has one application: through use of threat of force or other repercussion, you frighten the target. Whether the goal is to demoralize the target, or force them into submission, this is skill is all about inspiring fear in the target. Unlike Coercion that is uses fear to control, intimidation is not as sophisticated. To use intimidate you must succeed an Intimidation check with a DC of the target's passive Wisdom Saving Throw.

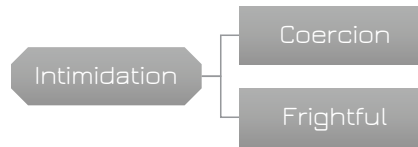

Coercion [Skill]

A skill that has many applications, coercion is the arguably inelegant art of forcing people to do what you want them through malice, force, and the application of emotional leverage. Generally, you can use Coercion to compel a character with whom you share a language to undertake one action that is within their ability, if sufficiently pressured. The default DC for any Coercion attempt depends on what is asked. The main issue with coercion is that it rarely if ever leads to sustained cooperation or obedience. Characters are entitled to a Wisdom Saving Throw against Coercion checks, particularly if they are not overly convinced of the dangers of non-compliance.

Frightful [Feat]

On your turn you can project your lethal intent to a range of 10 meters. Any creature that starts its turn in this sight of you must succeed on a Wisdom saving throw or frightened until the end of your next turn. A creature that succeeds on this saving throw is immune to your aura until you complete a long rest.

Performance

With a check under this skill you can delight an audience with music, dance, acting, storytelling, or some other form of entertainment.

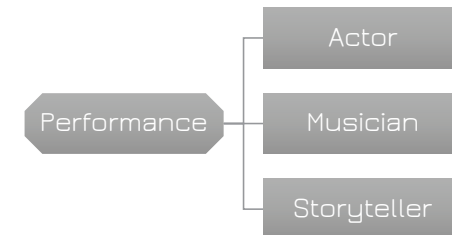

Musician [Feat]

Music probably predates humanity as we know it, our earliest ancestors no doubt sung songs that were different from language by rhythm or tonality or both. You can comfortably and easily carry a tune, perform a good range of vocal pieces, and carry or match a harmony. You are able to improvise and learn new song by ear. It is reasonable for a competent singer to be quite capable of a very wide range of sounds. Musical Performance checks are made with advantage.

Actor [Feat]

This skill is the art of pretending to be someone or something you are not, of transforming from one person to another believably. More than stage acting, this is skillfully expressing the emotions and presence of the façade. You can use acting as a disguise, or as part of a performance to move an audience. Impersonation and acting performance checks are made with Advantage.

Story Teller [Feat]

You can create or recite an engaging narrative and prose, as well as some practice in oratory, literature, and poetry. You can entertain and keep an audience's attention with this skill. Story telling performance checks are made with advantage.

Persuasion

You may attempt to sway someone or a group of people with tact, social graces, or good nature. To use persuasion, you must be acting in good faith, as duplicitous coercion is a different skill set. Persuaded targets are generally likely to agree with your point of view and see you in a favorable light. However, this is not a contact or connection (but might become one).



Dazzle [Feat]

You can dazzle a target through charm, conversation, and wit as your action. Choose a target who can understand you, they must succeed an Intelligence saving throw of 8 + your Proficiency bonus + your Charisma modifier. If the save fails, the target receives Disadvantage on attack rolls, ability checks, skill checks, and saving throws for as long as you continue to use Dazzle on your turn as your action for up to 1 round + your Charisma modifier.

Charm [Skill]

With this feat you can beguile and captivate a creature, winning them over for a short period of time. To use this feat, you must choose one creature who can see and understand you who is no more than 5 meters away. The target must succeed a saving throw DC 8 + your Proficiency Bonus + your Charisma modifier or be Charmed for rounds equal to your Charisma Modifier. You may use this feat as often as once per round.

Inspire [Feat]

You can inspire others through stirring words and presence. To do so, you use your action to choose one creature other than yourself you who can hear you. That creature gains one Inspiration die, a d6.

The creature can roll the d6 and add the number rolled to one ability check, attack roll, skill check, or saving throw it makes on its next turn. The creature can wait until after it rolls the d20 before deciding to use the Inspiration die but must decide before the GM says whether the roll succeeds or fails. Once the Inspiration die is rolled, it is lost. A creature can have only one Inspiration die at a time.

You can use this feat a number of times equal to your Charisma modifier (a minimum of once). You regain any expended uses when you finish a long rest.



TOOLS

Technology is what enables adventure in the future. Tool proficiencies allow you to add your proficiency bonus to any skill check made with that equipment. Tool use is not tied to a single ability, since proficiency with a tool represents broader knowledge. You might be called upon to make an Intelligence check with fabrication tools to construct a very complicated design, or a

Strength check with Mason's Tools to hew stone.

In many cases tools overlap with skills to augment each other or combine. If you are proficient in Sciences and Laboratories, you can synthesize advanced chemicals and processes. If you have Proficiency in Vehicles and Piloting, you can handle advanced aircraft. Proficiency with engineering and Fabrication tools allows you to construct advanced machines.

The line between a tool proficiency and a skill is blurred in some cases. Computers are just tools after all, but you might be called to make an Intelligent (computers) check to identify a hostile computer virus in the ship's system or detect that the merchant you are speaking with is in fact an advanced AI.

Artist's Supplies

You can sketch, draw, paint and shape a medium into works of art or practical design. You can craft reasonable pieces from imagination or from models and reference.

Appraise. You gain advantage on an investigation check to estimate the value of art and artistic artifacts you encounter, as well as appraise jewelry and other commodities.

Computers. You have advantage on attempts to use computers to create digital artwork.

Forgery. You can producer forgeries and fakes or documentation, papers, passes, identification, and works of art with Deception. Your deception skill check determines the DC needed to spot your forgery with an Investigation check.

Carpenter's Tools

This is complex wooden construction and fabrication, and with this specialty you can craft structures and furniture, be it a chair or a cabin.

Archery. You can create bows and arrows from raw materials on a DC 10 Archery check.

Engineering. You have advantage in engineering checks on wood structures, and can build complex wooden forms, such as siege engines and crossbows.

Culinary Utensils

No ship in the galaxy would turn down a skilled chef. You're proficient in cooking fine meals, pairing flavors, and prepping ingredients.

Simple Weapons. Chefs are dangerous with knives. You gain +1 to attack rolls and damage rolls with knives.

Survival. You have advantage on any Survival rolls made to prepare wild game and live off the land. You eat well even living rough.

Fabrication Tools

Cutting, shaping, and welding metal is collectively known as fabrication. Generally, this specialty distinguishable from black smiting only in that includes understandings of modern steel work and welding techniques.

Computers. You have advantage on computers checks made to program assembly machines and 3d printing technology.

Investigation. Attempts made to identify the structural integrity of a machined structure are done so with a +2 bonus.

Engineering. Engineering checks are made with Advantage if you have fabrication tools available.

Forensics Kit

The use of a forensics kit allows you to gather and preserve evidence for further analysis. You are proficient in the use of these tools such as print matching, DNA extraction, as well as crime scene etiquette.

Bureaucracy. You have advantage on law and litigation checks, by way of an understanding of the evidence gathering and handling techniques.

Investigation. You have advantage on investigation checks made to collect and connect evidence from crime scenes or from autopsies.

Sciences. You have advantage on sciences checks made to analyze evidence collected with a forensics kit.

Hunter's Kit

You're proficient in trapping, skinning, butchering, and preparing game for consumption. You can prepare hides and firs of slain game animals, and butcher animals in an efficient manner.

Survival. You have advantage on survival checks made to hunt food. You can make a modest living as a hunter/trapper.

Wilderness. You have advantage on checks to identify information about fauna in the wild, and advantage tracking animals.

Laboratory

You are familiar with laboratory equipment and process. You can synthesis basic chemicals and compounds as analyze them with spectrographic and other tools.

Science. You have Advantage on nearly all Science checks with laboratory access that are not simply recall. Advanced Science skills will allow you to use a lab to create sophisticated

compounds and equipment such as complex acids, high-power explosives, and drugs.

Medicine. Using a lab will provide you advantage on medical diagnostic and treatment checks. Furthermore, you can produce Med kits and Medi-Packs with a lab.



Make-up Kit

You are proficient in the use and application of beauty and stage make up.

Deception. You can create disguises with Performance or Deception, combining stage make up, prosthetics, and wigs to radically alter your appearance.

Persuasion. You can use make up to increase your aesthetic appeal, giving you advantage on seduction persuasion checks.

Med Kit

You are familiar with using an emergency medical kit, Med Kit, to forestall death in the case of events like heart attack, allergic reaction, and treating minor injuries like burns and cuts. You can use Med Kit to restore 1d4+1 hit points to an injured creature with at least 1 hit points, and give someone advantage on their first death saving throw.

Medicine. You have advantage on most medicine checks to treat injuries and stabilize a patient with a med kit.

Musical Instruments

You can play a wide range of instruments with proficiency.

Performance. Not only can you play, but you can jam. You gain advantage on musical

performance checks if you have an instrument and can arrange original music.

Primitive Tools

Stone, clay, wood. From the most rudimentary of materials you can craft usable tools such as sharp stone axes and spears, fire, pottery, kilns, and so on.

Survival. You have advantage on most survival checks made to find food, shelter and fire because you can make them with proficiency.

Wilderness. You gain advantage in attempts to trap animals.

Repair Kit

You should be able to bring most machines back to functioning order, as well as many simple electronics. The more advanced the machine the higher the DC and more sophisticated tools will be necessary to repair a machine. Generally, a patch job can restore 1d6 hit points per level per hour to a damaged machine.

Engineering. You can repair advanced systems, and can repair 10 hit points per level per hour.

Security Kit

Proficiency in security kit allows you to attempt to disable mechanical locks, traps and security measures, as well as jam or destroy a lock so that it cannot be opened.

Engineering. You can not only pick and disable locks you can also bypass very complicated locks through your understanding of lock mechanisms. You have advantage on lock picking checks.

Perception. You can also attempt to crack combination locks, listening closely to the tumblers and pins in the mechanism.

Vehicles

You can operate virtually all civilian surface vehicles. With a successful check you can perform challenging stunts and maneuvers describe in section 8 with proficiency. While you can likely perform basic maintenance with this skill, any kind of complicated repairs or modifications are likely too much.

Engineering. You can perform extensive and significant repair and modifications to your surface vehicles.

Piloting. If you are proficient in Piloting, you gain Advantage on any vehicle handling checks. You may add your Proficiency bonus to the AC and saving throws of ground vehicles.



TRAITS

Traits are unique proficiencies that are only available to members of specific species. Traits have no prerequisites other than being a biological member of the species in question but require a proficiency slot in order to develop.

Ba'alur

Claw unarmed attack [Skill]

You are proficient in unarmed attacks with your claws. You treat your claws as a light off-hand weapon for the purposes of two weapon fighting.

War Cry [Feat]

You can let out a tremendous roar which can frighten nearby creatures. On your turn you may use your action to Roar. Every creature with-in 15 meters must make a Wisdom saving throw DC 10 + Your Con modifier + Proficiency bonus or become frightened for rounds equal to your Constitution modifier.

Colonial

Aptitude [Feat]

When you select this feat, select one core proficiency with which you are proficient such as piloting, athletics, or computers. You discover you have a natural aptitude for this skill and when making skill checks with this proficiency, may add twice your proficiency bonus. You may not apply this trait to a skill that already has this benefit.

Human Perseverance [Feat]

With this feat, if you fail a saving throw with which you are proficient you may instead choose to succeed. You may use this feat once and recover the ability to do so following a long rest.

Ephari

Forgotten Purpose [Feat]

In the ultimate act of rebellion, you have

chosen to reject your Purpose freeing your mind from the shackles of your people. You no longer gain Advantage on skill checks made with the Skill that had been your purpose, and instead gain advantage on you Telepathy skill checks.

Trance [Skill]

Ephari meditation is nothing like the kind of mindfulness practiced by humans, Xhu, and even the Ba'alur. In this state the Ephari accesses an ancient part of their brain that in not like anything the other species possess. It takes one full round of concentration to attempt a meditative state (DC 15). While you are in this state, you have Advantage on Wisdom Saving Throws.

Once you have entered this state you may attempt a Trance check to recover one memory in perfect detail that you have experienced (DC 10) or share that memory with another being through Telepathy (DC 15). If this is a memory of a skill, you or the person you have shared this memory with will have Advantage on the next use of that skill. You may maintain this state for a number of hours equal to your Wisdom Score. If you maintain this state for more than three hours you may gain the benefits of a Long rest, however you still only enjoy the benefits of a long rest once per day. This state does not replace the need for sleep.

Empyrean

Heraldry [Skill]

There are millions of Empyreans in the galaxy, but every one of them has a cast and reputation. You can use this skill to attempt to identify any Empyrean. The base DC is 20. You add the target's Reputation to your roll.

Challenge [Feat]

The Empyrean are renown for resolving conflicts with duels between commanders. As a bonus action on your turn you may issue a challenge to a target that can see and hear you within 20 meters. If they accept, as a free action, you are locked into a Duel. You gain advantage on all attack rolls against each other. You have Disadvantage on attack rolls against any other target until you or the target of your challenge is reduced to 0 hit points. If your target attempts to flee, you may make a bonus action to attack them. If you defeat a target with a reputation score equal to, or greater than your own in a Duel, you immediately gain +1 Reputation. If you lose this duel, you immediately suffer a -1 reputation penalty.

Ixaxian

Technocant [Skill]

This is a unique language to the Ixaxian.

Other beings are only able to manage this radio frequency communication with the aid of cybernetics. Through this language you are able to communicate highly technical concepts and data, including mathematical information.

Remote Operations [Skill]

Any device equipped with a wireless control mechanism can be controlled by an Ixaxian with this skill. It takes a great deal of concentration for an Ixaxian to do this, if used in combat, the Ixaxian can only take actions to control their target and move. They cannot take bonus or reactions during the round.

Seyvul

A friend in need [Feat]

This modifies the Aid action. So long as a member of your crew has an item that you require and is within 3 meters, you can be considered to have that item, as at some point, you will have "borrowed" it. Likewise, if you have an item that a party member needs as a bonus action at any time in the round, you can make sure they have that item.

Thothid

Aura of Horror [Feat]

The Thothids are disturbing to behold, with this feat however you can create an aura of fear centered on yourself as a standard action. All creatures within 10 meters who can see you must make a Wisdom saving throw against 9 + your Charisma Modifier + your Proficiency Bonus or become frightened of you for 1 round plus your Wisdom Modifier. This ability has a psionic component, and anything that would affect psionic abilities will affect this power.

Dire Knowledge [Feat]

You know much more about your people and your power than your elders would like - or allow. This dire knowledge manifests as Resistance to psychic damage and Advantage on saving throws against psychic attacks.

Urroru

Claw unarmed attack [Skill]

You are proficient in unarmed attacks with your claws. While fighting in melee you may make one extra bonus attack with your claws, in addition to other bonus actions, on your turn.

Mechanical Aptitude [Feat]

Urroru are uniquely capable engineers and Technophiles. With this feat you may add twice your proficiency bonus to Jury-Rig, Repair,

and Mechanical engineering skill checks using Magisterium technology. You must be proficient in the skill to gain this bonus.

Unshakable [Feat]

The Xhu discovered much to their dismay that the Urroru are practically fearless. With this feat you have Advantage on all saving throws against being Frightened or suffering Anxiety.

Xhu Akreen

Rank and Regency [Skill]

To the Xhu Akreen success or failure is more than a matter of personal pride. Each and every Xhu belongs to one of a plethora of political bodies called Regencies, from the lowliest beggar to the mightiest general. You may make a rank and regency check to identify another Xhu's regency and overall social position. Moreover, you can attempt to leverage your Rank and Regency in the Magisterium when attempting to call in favors. If you are proficient in this skill, you may add your proficiency bonus to any attempt to call in a favor from a Magisterium contact.

Will of the Ancients [Feat]

With this feat, if you fail a Wisdom saving throw you may instead choose to succeed. You may use this feat once and recover the ability to do so following a long rest.



CONQUER

~~YOUR MOM~~
~~THE LAST~~



FRONTIER

SECTION 07 EQUIPMENT AND CONTACTS

Commerce and economy, contracts and deals - the galaxy is a busy place. For adventurers, the right gear makes the difference between life and death, and having the right connections is how you find jobs and get paid. In Advent Horizon you will make use of two primary resources to make your fortune - Credit and Reputation. Both are used to purchase what you need to adventure, but each in different ways.

CREDIT

Your Credit represents your total fiscal buying power - money, loans, equity, and savings. As adventurers you will start with enough Credit to be well equipped and ready to get into trouble.

Credit is represented as a Credit Modifier. This is exactly like your ability score modifiers and works the exact same way. When you are called upon to make a Credit Check, you will roll 1d20, and add your Credit modifier to the roll.

Credit Check = 1d20 + your Credit Modifier.

Purchase DC = 8 + the item's Credit Modifier + its availability modifier.

If the purchase's Credit Modifier is higher than your Credit Modifier, you take a -1 to your Credit Modifier.

All purchases - be it equipment, supplies, or services - have a Credit modifier, and a Credit check. When you want to purchase an item, you roll against the Credit check DC if the item, adding your Credit modifier to the roll. If you succeed the check, you can afford the purchase.

Starting Credit

At 1st level your Credit Modifier is 1d4 + Wisdom modifier + profession bonus, with a minimum credit modifier of 0.

Spending Credit

There are several ways you might spend Credit - and decrease your Credit modifier.

The first is by making costly purchases. Any time you make a Credit check to buy a product or service with a Credit modifier higher than your own, you lose one point off your Credit modifier.

Example, Kiddian Graves is a Combat Spec with a Credit modifier of +6. He decided he needs an upgrade after a particularly tough fight with several Ba'alur Mercenaries and elects to get a Cybernetic Strength implant. This implant has a cost of 16 and a Credit modifier of +8. Kiddian handily makes the purchase rolling a 17 (+6) to make a check of 23, but because the upgrade has a higher Credit modifier than his own (+8 vs. +6) his Credit decreases by 1, to become +5.

The second way to spend Credit is to Debt a purchase. Any time you roll a Credit Check you may voluntarily reduce your Credit Score by 1 to gain Advantage on the Check. This cost is applied after the Credit check is made, succeed or fail. If the purchase's Credit modifier exceeds your Credit modifier, you still must pay the 1-point Credit cost.

Collective Buying power

Multiple people can pool their resources to make big purchases. In this case, each person adding to the pool increases the Credit modifier of the highest purchaser by 1. One purchaser can credit the purchase as well, gaining the primary buyer advantage on the roll. If more than one contributor chooses to credit the purchase, they increase their contribution to +2 Credit check, advantage is still only rolled once. As with any purchase, if the Credit modifier of the purchase exceeds the total Credit modifier of the pool, all contributors to the pool see their Credit decreased by 1.

Gaining Credit

There are plenty of ways to gain Credit too. Being paid for jobs, salvaging equipment, selling raw goods - all of these can net you a handsome profit.

Selling Loot. Selling Goods such as looted weapons or artifacts will net you one half the article's Credit modifier, rounded down, to a legitimate buyer. For example, selling a knock off brand pistol with a +2 Credit Modifier would net you +1 Credit. You can also potentially trade items while making a purchase. With each item that has a full Credit modifier higher than your own adding +1 to your Credit check, unless it is more than double your Credit modifier, in which case it adds +2.

Selling things to less reputable buyers, pawn hawks, or the back market will probably only net the character one third or a quarter of the Credit modifier but are more likely to buy loot than many legitimate businesses.

Experienced Adventurers will probably have Credit modifiers in the double digits. Which is important, as most of the best equipment will too. Some things, such as capitol ships and space stations have Credit modifiers and checks so high one person probably can never afford.

Its all about the Money

Credit represents buying power, not just liquid currency. After all some cultures, like the Ixaxians and Seyvul have no currency. Yet trade and commerce continue. The system relies upon decentralized commercial networks that count or record a person's capital and capacity. When dealing with the socialist societies of the Arc, their own commercial systems examine the credit of perspective buyers to determine if they have the buying power, or more often, simply barter for trade goods.

REPUTATION

In a future with a vast internet and collective information system, Reputation embodies your collective professional credibility, reach of your social network, and to some degree your influence in the galaxy. Like Credit, this is represented as your Reputation Modifier, which you add to your reputation checks. When you are called upon to make a reputation check you will roll 1d20 and add your reputation modifier.

Reputation Check = 1d20 + your Reputation Modifier.

Favor DC = 8 + the item's Credit Modifier + it's availability modifier.

Networking DC = 8 + the contact's Reputation Modifier.

If the item's Credit Modifier is higher than your Reputation Modifier, -1 to your Reputation Modifier.

Starting Reputation

Your starting Reputation Modifier is +1, plus any bonuses from high Charisma and your Background.

Using Reputation

You can leverage your reputation in several ways. The first is to add contacts and connections. These are individuals or groups of non-player characters you know who can provide you with useful information or services, increase you access restricted goods, or potentially line you up with work. The competence and scope of a contact or connection sets the initial Reputation check necessary to add them to your network. Unlike Credit there is no way to debt or gain a bonus to this check by losing reputation. However, the GM may grant you advantage on this roll for excellent role playing, or other similar situational bonuses.

Once you have added a contact or connection, you can rely upon them to regularly provide their service (at times for a small fee). Your contacts and connections may ask favors of you in return, and repeatedly making use of criminal connections could put you in danger with the law or even rival criminal organizations. Contacts and connections are detailed below.

The second application of reputation is calling in favors. In this situation, you rest on your reputation to obtain goods or services from a contact or connection. This functions exactly like

a Credit check purchase check; however, you rely on your reputation. Asking for a favor with a higher Credit Modifier than your current reputation modifier will hurt your reputation just like a Credit check. If you are willing to make a deal, you can credit a favor too. Just like a Credit check you gain Advantage on your Reputation Check, at the cost of 1 point off your reputation modifier. But this comes with strings attached. You now “owe” the contact or connection.

At some point down the line, the contact will call this favor in. Failure to meet this request might result in the loss of that contact or connection, or even further loss of reputation.



Building Reputation

Reputation is based on what you do. It cannot be easily bought or sold, and your role playing and actions will determine what becomes of your reputation throughout your career. That said, there are several ways you will gain reputation through out your career.

Gaining Levels. Your base reputation modifier is equal to your total character level. So with each level you gain, you add +1 to your reputation modifier. This is not a guaranteed value. Facing regular failures and constantly asking for bad favors can lower your reputation below this

value, but as you accomplish feats that gain you experience levels you will inevitably gain some reputation.

Accomplishments. Like Inspiration, when you do something particularly noteworthy, dramatic, or exceptional, the GM may provide you with a point of reputation. These may come from doing jobs for contacts or being in the right place at the right time. When an accomplishment increases your reputation is at the sole discretion of the GM, but generally when you complete a significant mission provided by a contact you should gain a +1 to your current reputation modifier.

Doing Favors. Finally, when someone asks you for a favor – such as a service or goods – you can choose to do so, potentially increasing your reputation. Only significant favors matter in this case; loaning a few credits to an NPC does not qualify but smuggling a family through an Imperial blockade certainly would. In many cases favors and jobs blur together, the difference is you are generally not paid for favors.

Losing Reputation

Just like building reputation, it is possible to hurt your reputation with your actions. When you hurt your reputation, you suffer a -1 to your reputation modifier.

Asking Favors. Particularly big favors can hurt your reputation. Anytime you make a request of a contact or connection with a Credit modifier higher than your reputation modifier, you hurt your reputation, suffering -1 to your reputation modifier. Crediting and owing a favor in return will also hurt your reputation modifier by 1.

Failing Contacts or Connections. In instances where you fail to meet your contact's or connection's needs, or otherwise mistreat them, you might hurt your reputation. The GM determines if your actions have done damage to your reputation, but generally when you fail at a task of job set out by your contacts or connections, fail to repay a favor or debt, or act against the interests of your connections, your reputation suffers. In such an instance, the GM may decide that your reputation modifier is reduced by 1 due to your actions.

EQUIPMENT

Armor, weapons, tools, communicators and vehicles - adventure requires a lot of gear. In Advent Horizon, your tools and technology are how you leverage your skills. In other words, your gear matters.

Cost and Availability

Goods and Services are purchased with a Credit check against the target Purchase Check DC. The purchase DC for most goods and services is equal to 8 + the item's Credit Modifier + it's availability modifier.

Availability changes the cost of most purchases. When something is Uncommon or Rare, it costs more because it is a commodity. Goods and services can also be Restricted - in these cases, they cannot be bought unless a character also has a Contact or Connection that opens that specific limited availability. There are multiple kinds of Restricted availability, and each connection will allow one class, such as Restricted (Illegal) or Restricted (Government).

Universal (-2). Goods or services with this availability are everywhere and can be acquired at little cost.

Common (+0). Common goods are found at most merchants or sellers, or such services are widely known and available.

Uncommon (+1). Products or Services that are Uncommon require purchase from a niche vendor, or a specialized provider and may not be available in particularly remote locations.

Rare (+2). At this point, goods become hard to find commodities or specialist items, and services become hard to find. Such goods and services are not widely known of or traded in.

Restricted (+4). These goods or services or either limited to an organization, species, or world, or are outlawed in most of the galaxy. Finding a merchant dealing in restricted goods or services is highly specialized, and the cost is exorbitant. General restriction types are Corporate, Government, Illegal, License, Species, or Planetary.

Unique (+8). A unique item is one of a kind, and the only one known to exist, and cannot be reproduced faithfully.

Mastercraft

Not all equipment is created equal. Equipment produced with cutting edge materials and superior craftsmanship is considered Mastercraft. Mastercraft equipment will offer a bonus you between +1 and +3 on one aspect such as attack roll, armor rank, or a skill check.

Mastercraft equipment is far less availability than their mass-produced counterparts. For each +1 bonus of the master crafted item, availability moves down towards unique. A mastercraft +1 handgun would become rare, where as a rare item would become restricted, and so on.

ARMOR

The Galaxy is a dangerous place, so it should be no surprise the most species developed artificial armor as protection against hostile creatures and the rigors of space. This section collects armor and protection that is common throughout the known galaxy, and that is likely to be encountered. The Armor table presents each armor by category, their mass, AC modifier, and Armor Rank Modifier, as well as any special qualities they may possess.

Ancient Armors. When you hear armor, you might think of a knight in a suit of plate and mail. This kind of archaic armor is not something you find out in space generally, but it's not unheard of. The major problem is that archaic armors don't provide the same kind of protection against firearms and energy weapons that modern armors can. Archaic armors or constructed of materials that can offer that protection are no longer archaic armor.

Tactical Armors. Armor crafted from ballistic impact polymers or attached to a powered frame, modern armor is often much more light weight and protective than ancient analogs. Modern armors can absorb some or all the damage from many types of attack, when being worn by someone with sufficient training.

Armor Proficiency. Anyone can strap on armor and gain the benefit to armor class that the armor provides, at the cost to some mobility. Those with Armor Proficiency have the ability to leverage that armor efficiently and may find the amount of damage they suffer is reduced by a certain amount.

Armor Class. Armor protects its wearer from attacks. The armor and protective regalia you wear sets your base Armor Class. If an attack roll does not meet or exceed your armor class, the attack misses or does no damage.

Armor Rank Modifier. If you are proficient in a suit of armor, your Armor Rank is equal to your Armor Class plus your proficiency bonus. When an attack beats your Armor Class but is less than your Armor Rank the amount of damage you sustain from the attack is reduced by the armor's Armor Rank Modifier. Some Special abilities might increase your Armor Rank Modifier or bypass an opponent's.

Armor Table

Armor	Armor Class	AR	Credit Mod	Mass	Properties
Light Ancient Armor					
Padded Gambeson	11 + Dex mod	-	+2 uncommon		Stealth
Worked Leather	12 + Dex mod	-	+1 common		Concealed
Light Tactical Armor					
Graphene Fiber Coat	11 + Dex mod	+2	+4 common		Concealed
Light Ballistic Vest	12 + Dex mod (max 2)	+4	+3 uncommon		Concealed
Medium Ancient Armor					
Boiled Leather	12 + Dex mod	-	+2 uncommon		
Chainmail	14 + Dex mod (max 2)	-	+3 rare		
Half Plate	15 + Dex mod (max 2)	-	+5 rare		Stealth
Medium Tactical Armor					
Ballistic Carrier Vest	14 + Dex mod	+6	+5 uncommon		
Graphene Combat Mail	16 + Dex mod	+6	+8 uncommon		STR 13
Light Exo-suit	15 + Dex mod (max 2)	+4	+10 uncommon		Environmental, stealth
Heavy Ancient Armor					
Splint Mail	17	-	+6 rare		Stealth, STR 15
Full Plate	18	-	+8 rare		Stealth, STR 15
Heavy Tactical Armor					
Modular Combat Armor	16 + Dex mod (max 2)	+8	+12 rare		Stealth, STR 15
Ballistic Plate	18	+8	+12 restricted		Stealth, STR 15
Assault Exo-suit	20	+10	+15 restricted		Environmental, stealth, STR 16
Powered Armor					
Tactical Frame	11 + Dex mod	-	+18 rare		Special
Powered Hard Suit	18	+10	+19 restricted		Stealth
Titan Assault Armor	22	+15	+24 restricted		Environmental, Stealth

Armor Properties

Protective equipment can have several properties which will be listed on the armor properties table.

Concealed. This armor is not obvious and can be worn as or under clothing.

Environmental. Some armor will protect you from hostile environments or the rigors of space, armor with "Environmental" in the properties column on the armor table has this characteristic. All environmental armors have the following traits:

- Sealed when the helmet is on and provides 6 to 8 hours of oxygen. This provides immunity to vacuum and toxic gasses.
- Radiation Shielding which provides immunity to

casual radiation exposure.

- Bio-monitor computer that monitors your health and O2 levels, as well as external and internal temperature and time.
- Built in short-range digital communication system (2km).
- Built in headlamps.
- Built in 150m tether and electric winch (STR 11)
- Maneuvering thrusters to position and orient in microgravity.

Restricting. If the Armor table shows "Restricting" in the Properties column, the wearer has disadvantage on Dexterity (stealth) checks.

Required Strength. Archaic armor, and

extremely heavy suits of modern armor, may have a minimum strength requirement. Wearing armor that you are not strong enough to use, even if you are proficient, will impose Disadvantage on Attack rolls, Strength and Dexterity skill checks. Strength requirements will be shown as STR plus a number that is the strength score needed in the armor's properties column.

Light Armor

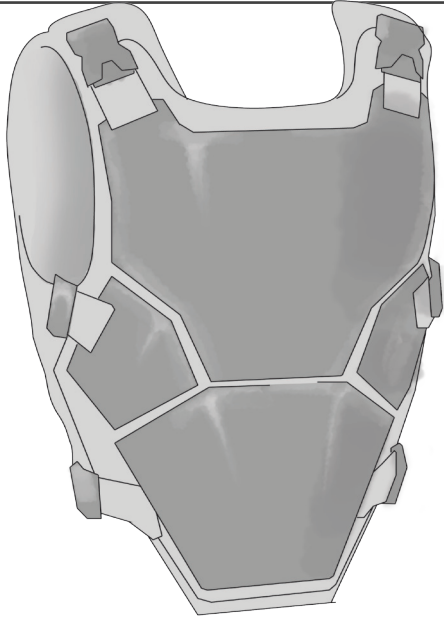

This armor is low weight, made from flexible materials, or only covers the most vital regions. Light Armor favors those who prize mobility over protective power. Light armor cannot be environmental.

Graphene Fiber Coat

Hailed as a wonder material, graphene fiber is a mesh of long strands of carbon nanofibers woven together into a rugged protective material used universally in modern armor. The stats here are for an overcoat or reinforced jacket of this material.

Light Ballistic Vest

A protective vest of graphene fiber with light polymer plates to reduce impact damage. The vest generally only protects the core and shoulders.

Medium Armor

Full suits of light tactical gear and non-combat EVA hard suits fall into this category. While medium armor offers more protection than light armor, but it also impairs movement more. In medium armor you may not add all your Dexterity modifier to your Armor Class, depending on the armor.

Ballistic Carrier Vest

This rugged vest of polymer protective

graphene fibers with hard plates and pauldrons protects the core of the body from lethal attack. A rugged battle uniform of graphene fiber along with combat gauntlets and boots.

Graphene Combat Mail

The standard battle armor used by the Imperium, Graphene mail resembles medieval half plate made from Graphene mesh, nanocarbon plates, and ballistic insulators.

Light Exo-Suit

A standardized protective spacesuit, the light exo-suit features a series of protective fiber layers and a hard visor helmet with heads up display and universal computer jack

Heavy Armor

Environmental Combat suites and planetary assault armor are examples of Heavy armor. These offers supreme protection but limited mobility. Most heavy armor restricts some or all of your Dexterity modifier bonus to Armor Class but can potentially defend against significant damage.

Modular Combat Armor

Designed for mobility and protection, modular combat armor features a full suit of graphene fiber armor with hard plates of nanocarbon embedded in the armor. Thick protective gloves and boots come standard with this armor.

Ballistic Plate

Built with a combination of graphene fiber weave, graphene mail, and plates of super strong nanocarbon, ballistic plate combat armor is the ultimate in tactical protection. Multiple interlocking plates are attached to a form-fitting suit that evenly distributes the weight across the body. A masked combat helm is often equipped with multi-optics.

Assault Exo-Suit

The rise of space combat gave birth to the assault exo-suit, a form-fitting spacesuit with layers of nanofiber and hard plate protection.

Powered Armor

The ultimate in protection and exploration, Power Armor is essentially an armored robotic exoskeleton the provides superior augmented strength and mobility, but not without some drawbacks. Super-heavy power armor is sometime referred to as a mech or mech suite.

Regardless of what type, all power armor provides the following bonuses if you are proficient:

- + 4 Strength score
- Increase Carrying Capacity by half
- Increase Movement by 5 meters

- Onboard computer system and communicator
- 10-hour operational power supply, with solar back-up (recharges in 24 hours of sun). Can operate in power saving mode, with no strength of speed bonuses for up to 36 hours.

Tactical Frame

As the name implies, the Tactical frame is a light exoskeleton frame designed to act as a carrier for mobile heavy weapons or heavy tactical armors such as the ballistic plate or modular combat armor. The stats represent wearing just the frame, and not wearing attached armor.

Powered Hard Suit

What most people consider when they think of powered armor, this exoskeleton is equipped with layers of hard ballistic plates and is designed to withstand serious damage.

Titan Assault Armor

The heaviest armor that is still power armor and not a mech, Titan Assault Armor is fully environmental and comes equipped with a built in set of thrusters, impact dampeners, and a KZM shield.

Thrusters. The armor's Thrusters can accelerate at 2.4m/s and allow you to leap three times as far.

KZM Shield. Provides a 10-point shield, and resistance to radiation damage.

Power Supply. Onboard fusion power supply can operate for up to 48 hours.

Getting Armor On and Off

The time it takes to don or doff armor depends on the armor's category.

Don. This is the time it takes to put on armor. You benefit from the armor's AC only if you take the full time to don the suit of armor. Ancient armors are much more complicated, and these times are double for archaic suits.

Doff. This is the time it takes to take off armor. If you have help, reduce this time by half. Ancient armors are much more complicated, and these times are double for archaic suits.

Donning and Doffing Armor

Category	Don	Doff
Light Armor	30 seconds	1 round
Medium Armor	2.5 minutes	30 seconds
Heavy Armor	5 minutes	2.5 minutes
Powered	1 minutes	1 round (or 1 action "Eject")

WEAPONS

Exploring the frontier of the galaxy is often a dangerous endeavor. Besides the hostile and uncaring void of space, adventurers face marauders, dangerous alien creatures, and ancient war machines. The Arms table shows the most common weapons available in the galaxy, their price and mass, the damage they deal when they hit, and any special properties they possess. Every weapon is classified as either melee or ranged. A melee weapon is used to attack a target within reach of you, whereas a ranged weapon is used to attack a target at a distance or in an area.

Weapon Proficiency. Your skills can grant you proficiency with specific weapons or groups of weapons, such as simple melee weapons or simple guns. Most modern weapons fall into categories such as Handguns, Rifles, Energy Pistols or so on. Most Ancient weapons are learned individually as skill requires more specialized training to use effectively. Proficiency with a weapon allows you to add your proficiency bonus to the attack roll for any attack you make with that weapon. If you make an attack roll using a weapon with which you lack proficiency, you do not add your proficiency bonus to the attack roll and may suffer disadvantage.

Weapon Properties

Most arms have special properties related to their use, as shown in the weapons table.

Ammunition. All modern weapons require ammunition to fire, be it bullets, flechettes, or energy cells. Each time you attack with the weapon, you expend one piece of ammunition. Most handheld weapons store ammunition in a clip or canister that can be replaced as a ready action. The amount of ammunition stored in a standard clip will be listed in this column on the arms table.

If you use a weapon that has the ammunition property to make a melee attack, you treat the weapon as an improvised weapon (see "Improvised Weapons" later in the section).

Armor Piercing. Some ammunition and powered melee weapons will have the armor piercing property. These extremely dangerous weapons will ignore a set amount of armor rank listed in parenthesis. For instance, an armor piercing round with an AP (4) would ignore for points of armor rank modifier on a successful attack subject to armor rank.

Burst. This ranged weapon is capable of automatic fire, releasing a burst of rounds. The damage for the burst, and the number for rounds will be listed in parenthesis, separated by a slash.

Explosive. Grenades, rockets, missiles, and

some special ammunition explode, dealing damage in an area of effect. All creatures in the area of effect take full damage unless they succeed a Dexterity saving throw DC 8 + your dexterity modifier, for half damage. If you are Proficient in the weapon add your proficiency bonus to the save DC. The number in parenthesis is the area of the explosion.

Finesse. When making an attack with a finesse weapon, you use your choice of your Strength or Dexterity modifier for the attack and damage rolls. You must use the same modifier for both rolls.

Heavy. These large weapons are usually two handed. Small creatures have disadvantage on attack rolls with heavy weapons. A heavy weapon's size and bulk make it too large for a Small creature to use effectively.

Light. A light weapon is small and easy to handle, making it ideal for use when fighting with two weapons.

Loading. Because of the time required to load this weapon, you can fire only one piece of ammunition from it when you use an action, bonus action, or reaction to fire it, regardless of the number of attacks you can normally make.

Range. A weapon that can be used to make a ranged attack has a range in parentheses after the ammunition or thrown property. The range lists two numbers. The first is the weapon's normal range in meters, and the second indicates the weapon's long range. When attacking a target beyond normal range, you have disadvantage on the attack roll. You can't attack a target beyond the weapon's long range.

Reach. This weapon adds 2 meters to your reach when you attack with it, as well as when determining your reach for opportunity attacks with it.

Special. A weapon with the special property has unusual rules governing its use, explained in the weapon's description.

Threat. This weapon effects an area, such as fully automatic weapons and shotguns with scattershot. If the target is medium size or smaller, adjacent creatures within 2 meters must succeed a dexterity saving throw DC 8 + your Dexterity modifier or suffer the damage listed in parenthesis. Add your Proficiency modifier if you are proficient in the weapon. Large and larger creatures take additional damage listed in parenthesis, and adjacent creatures are not at risk. The first number listed in parenthesis is the number of rounds consumed in each attack.

Thrown. If a weapon has the thrown property,

you can throw the weapon to make a ranged attack. If the weapon is a melee weapon, you use the same ability modifier for that attack roll and damage roll that you would use for a melee attack with the weapon. For example, if you throw a hatchet, you use your Strength, but if you throw a dagger, you can use either your Strength or your Dexterity, since the dagger has the finesse property.

Two-Handed. This weapon requires two hands when you attack with it.

Variable. This weapon can accept multiple sizes of ammunition or can be set to a higher power output. The damage for the larger caliber bullet or higher damage output will be listed in parenthesis.

Versatile. This weapon can be used with one or two hands. A damage value in parentheses is the damage when the weapon is used with two hands to make a melee attack instead of 1.

Improvised Weapons

Sometimes characters run out of ammo or lose their weapons and attack with whatever is at hand. An improvised weapon includes any object you can wield in one or two hands.

Often, an improvised weapon is similar to an actual weapon and can be treated as such. For example, a table leg is akin to a club. At the GM's option, a character proficient with a weapon can use a similar object as if it were that weapon and use his or her proficiency bonus.

An object that bears no resemblance to a weapon, such as a pistol butt or a ballpoint pen deals 1d4 damage (the GM assigns a damage type appropriate to the object). If a character uses a ranged weapon to make a melee attack or throws a melee weapon that does not have the thrown property, it also deals 1d4 damage. An improvised thrown weapon has a normal range of 7 meters and a long range of 20 meters.

Ancient Weapons

In the confines of a pressurized spaceship firearms and energy weapons can have disastrous consequences on a miss. For this reason, ancient weapons such as swords and hammers inevitably experienced a revitalization for close quarters ship or station-board combat.

Weapons Table

Weapon	Damage	Mass	Credit Mod		Range	Properties
Simple Weapons						
Baton	1d6 bludgeoning	0.5kg	+1 uncommon	-	-	Light
Bat	1d6 bludgeoning	1kg	+1 common	-	-	Versatile (1d8)
Combat Knife	1d4 slashing	0.3kg	+2 uncommon	-	3m/10m	Finesse, light, thrown
Dagger	1d4 piercing	0.3kg	+2 uncommon	-	5m/15m	Finesse, light, thrown
Hatchet	1d6 slashing	0.5kg	+1 uncommon	-	-	Light, thrown
Hammer	1d6 bludgeoning	1.5kg	+1 common	-	-	
Short Spear	1d6 piercing	1.5kg	+1 uncommon	-	10m/20m	Thrown
Staff	1d6 bludgeoning	3kg	+1 universal	-	-	Versatile (1d8)
Stun Gun	2d4 electrical	0.5kg	+1 uncommon	-	-	Special
Simple Guns						
.22 Pocket Derringer	2d4 impact	0.5kg	+2 uncommon	4+1	10m/30m	Light
.38 Revolver	2d6 impact	0.5kg	+2 common	6	10m/50m	
.22 Light Auto Pistol	2d4 impact	0.3kg	+2 uncommon	35	10m/20m	Burst (3/5d4), light
.17 Bolt Action Rifle	3d4 impact	3.5kg	+2 uncommon	10	100m/200m	Two-handed
.22 Semiauto Carbine	3d4 impact	2kg	+3 uncommon	55	30m/60m	Burst (3/6d4), two-handed
20-Gauge Shotgun	5d4 impact	3.5kg	+3 uncommon	2	10m/20m	Two Handed, threat (1/2d4)
Light Crossbow	1d6 piercing	1kg	+1 uncommon	1	10m/40m	Light, loading
Light Laser Pistol	1d8 thermal	3kg	+4 uncommon	12	10m/40m	Light
Plasma Carbine	2d8 thermal	4.5kg	+6 uncommon	10	15m/40m	Two-Handed
Ancient Weapons						
Arming Sword	1d6 slashing	1kg	+2 rare	-	-	Light
Broadsword	1d8 slashing	1kg	+3 uncommon	-	-	Finesse
Axe	1d8 slashing	2kg	+2 uncommon	-	-	Versatile (1d10)
Executioner's Sword	2d6 slashing	3kg	+4 rare	-	-	Heavy, two-handed
Flail	1d8 bludgeoning	1kg	+1 rare	-	-	
Katana	1d8 slashing	1.2kg	+4 uncommon	-	-	Finesse, versatile (1d10)
Longsword	1d8 slashing	1.5kg	+3 rare	-	-	Versatile (1d10)
Morningstar	1d8 piercing	2kg	+1 rare	-	-	
0 Dachi	1d12 slashing	3kg	+4 rare	-	-	Heavy, reach, two-handed
Pole-arm	1d10 slashing	3.5kg	+2 uncommon	-	-	Heavy, two-handed
Rapier	1d8 piercing	0.5kg	+2 rare	-	-	Finesse
Wakizashi	1d6 slashing	0.5kg	+3 uncommon	-	-	Finesse, versatile (1d8)
Powered Weapons						
Chain-knife	2d4 slashing	1.5kg	+3 uncommon	1	-	
Thermal knife	1d4 slashing	0.8kg	+4 uncommon	1	-	Light, +1d10 thermal
Shock baton	1d6 bludgeoning	1kg	+3 common	1	-	Special +1d8 electrical
Stun-knuckles	1d4 bludgeoning	0.2kg	+3 uncommon	1	-	Special +2d4 electrical
Thermal saber	1d8 slashing	2kg	+5 rare	1	-	Versatile (1d10), +1d10 thermal

EQUIPMENT & CONTACTS

KZM Beam Blade	1d10 slashing	5.5kg	+12 rare	1	-	+2d10 force, two-handed
Archery						
Short Bow	1d6 piercing	0.8kg	+2 uncommon	1	25m/100m	Two-handed
Longbow	1d8 piercing	1kg	+3 uncommon	1	50m/200m	Two-handed
Recurve Bow	1d8 piercing	0.8kg	+3 uncommon	1	25m/100m	Two-handed
Hunting Crossbow	1d10 piercing	3kg	+2 common	1	25m/200m	Loading, two-handed
Handguns						
.357 Revolver	3d6 impact	1.1kg	+4 uncommon	8	20m/50m	
.357 Semiautomatic	4d6 impact	2kg	+4 common	8+1	25m/100m	
Variable Shell Revolver	3d6 impact	1.8kg	+5 uncommon	6	20m/60m	Variable Ammo (3d8)
9mm Heavy Semiauto	4d6 impact	1.2kg	+4 uncommon		30m/60m	
9mm Semiautomatic	3d6 impact	1kg	+4 common		20m/50m	Burst (3/6d6), light
9mm fully automatic	4d6 impact	2.2kg	+5 uncommon	25	10m/30m	Threat (5/2d6)
10mm Semiautomatic	3d8 impact	1.3kg	+4 uncommon	8+1	20m/100m	Burst (3/6d8)
10mm Recoilless	2d8 impact	1.1kg	+5 common	30	10m/25m	Special, burst (3/4d8)
.45 Semiautomatic	4d8 impact	1.8kg	+5 common	7+1	25m/75m	
.44 Revolver	4d10 impact	1kg	+5 uncommon	6	50m/100m	
.454 Revolver	3d10 impact	1.5kg	+4 rare	6	25m/75m	Heavy
.50 Semiautomatic	5d10 impact	2.2kg	+6 uncommon	8+1	25m/50m	Heavy
Energy Pistols						
Variable Laser	2d4 thermal	2.4kg	+6 common	13	20m/50m	Variable (2d6)
Pulse Laser	2d4 thermal	2.1kg	+6 uncommon	18	20m/50m	Burst (3/5d4)
Plasma Pistol	3d6 thermal	2.5kg	+7 rare	10	15m/40m	
Ion Pistol	2d6 electrical	2.4kg	+7 rare	8	10m/30m	
Graviphoton Pistol	8d8 force		+14 restricted	5	100m/300m	Heavy
Rifles						
.30 Carbine	3d6 impact	2.6kg	+6 rare	15	75m/150m	Variable (3d8)
.308 Bolt action	5d8 impact	5kg	+5 uncommon	4+1	200m/600m	Two-handed
.338 Bolt action	5d10 impact	5.2kg	+6 uncommon	5	600m/1200m	Heavy, two-handed
.50 Semiautomatic	5d12 impact	14.4kg	+8 restricted	10	800m/2000m	Heavy, two-handed
12Gauge pump shotgun	3d6 impact	3kg	+7 uncommon	8+1	10m/20m	Threat (1/2d6), two-handed
12Gauge Semiauto	4d6 impact	4kg	+7 rare	7	20m/40m	Threat (1/2d6), two-handed
6.5mm Semiautomatic	5d6 impact	4.6kg	+8 rare	5	200m/600m	Burst (3/10d6), two-handed
7.62 Automatic Rifle	4d6 impact	4.5kg	+7 uncommon	35	100m/300m	Burst (5/10d6), threat (10/2d6), two-handed
7.62 Machinegun	5d8 impact	5kg	+8 restricted	15	300m/900m	Burst (3/10d8), threat (10/2d8), two-handed
Energy Rifles						
Laser carbine	4d4 thermal	8.4kg	+8 rare	20	100m/300m	Two-handed
Variable laser rifle	3d6 thermal	9kg	+8 restricted	15	100m/300m	Two-handed, Variable (3d8)

EQUIPMENT & CONTACTS

Pulse laser rifle	4d4 thermal	9.2kg	+10 restricted	20	75m/150m	Burst (3/8d4), two-handed
HI Laser	3d8 thermal	7.5kg	+10 restricted	8	300m/900m	Two-handed
Plasma Accelerator	5d8 thermal	11kg	+12 restricted	10	50m/200m	Heavy, two-handed
Ion Beam Cannon	6d6 electrical	9.8kg	+11 restricted	10	50m/200m	Heavy, two-handed
Particle Accelerator	4d10 radiation	13kg	+16 restricted	5	800m/2000m	Heavy, two-handed
Graviphoton Beam Rifle	6d10 force	17kg	+24 restricted	3	900m/3000m	Heavy, two-handed
Heavy Weapons						
7.62 Auto machinegun	6d8 impact	11kg	+10 restricted	500	100m/300m	Heavy, threat (10/2d8), two-handed
.50 Automatic cannon	8d12 impact	19kg	+12 restricted	300	600m/1200m	Heavy, threat (10/2d12), two-handed
Rocket Launcher	10d8 thermal	21kg	+8 restricted	1	150m/200m	Heavy, Explosive (10m), two-handed
Anti-Tank missile	10d6 bludgeon	26kg	+14 restricted	1	400m/1200m	+10d6 thermal, explosive (5m), two-handed
Fission missile launcher	20d6 radiation	31kg	+24 restricted	1	500m/1800m	+20d6 impact, explosive (20m), two-handed
Rail Guns						
Light Mass Driver	20d4 impact	16kg	+15 restricted	30	600m/1200m	Heavy, two-handed
Semiauto Mass Driver	10d6 impact	18kg	+16 restricted	50	150m/200m	Burst (5/20d6), heavy, two-handed
Heavy Mass Driver	20d6 impact	22kg	+24 restricted	10	800m/2000m	Heavy, two-handed
Explosives						
Incendiary Grenade	3d6 thermal	0.5kg	+2 restricted	-	10m/30m	Explosive (5m), Thrown
Thermobaric Grenade	5d6 thermal	0.4kg	+3 restricted	-	10m/30m	Explosive (5m), Thrown
Concussion Grenade	3d6 bludgeoning	0.4kg	+1 restricted	-	10m/30m	Explosive (5m), Thrown
Frag Grenade	4d6 impact	0.4kg	+1 restricted	-	10m/30m	Explosive (5m), Thrown
Shock Grenade	2d6 electrical	1.1kg	+5 restricted	-	10m/30m	Special, explosive (5m), Thrown
Flash Bang	1d4 sonic	0.3kg	+4 rare	-	10m/30m	Special, explosive (10m), Thrown
Satchel Charge	3d8 impact	1.8kg	+2 rare	-	5m/10m	+3d8 thermal, explosive (7m), Thrown

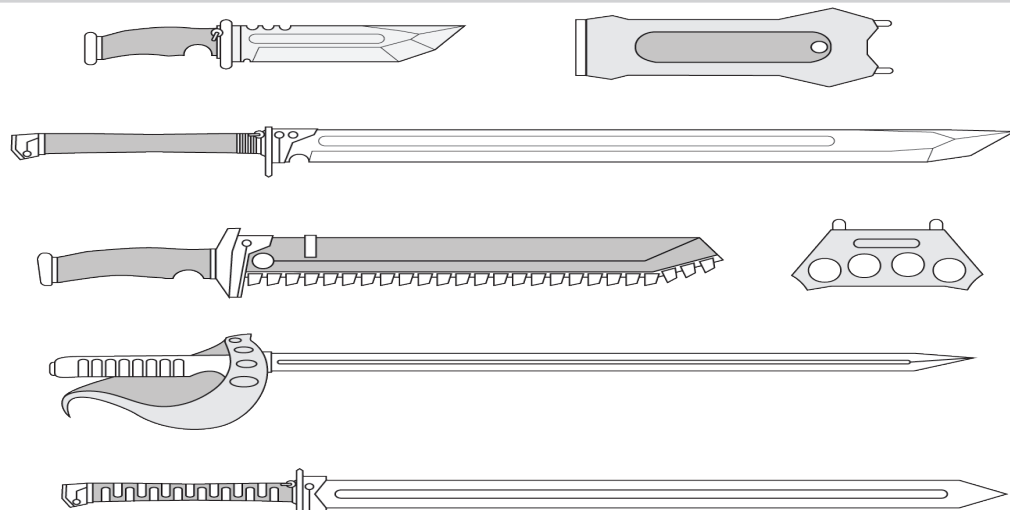



Energy Weapons

Directed energy weapons often supplant firearms in micro-gravity because they produce a significant amount of energy, without much counterforce. The common types of energy weapons are lasers, plasma, and ion beams (also called electrolasers). Extremely advanced energy weapons such as particle beams use excited neutron release a beam of exotic particles.

Explosives

Owing to the force created by violent chemical reactions, explosives are used for area effect and suppression.

Shock Grenade

These emit a powerful electromagnetic pulse. Electronics within range are disabled until repaired (DC 15).

Flash Bang

Anyone who fails their Dexterity saving throw is Blinded and Deafened for 1d4 minutes.

Firearms

Hand held firearms are still the most efficient and lethal modern weapons. It's hard to beat the devastation of a fast, high mass projectile, though in space the recoil poses its own risks.

10mm Recoilless

This pistol has no recoil and is safe to use in microgravity.

Heavy Weapons

These are the largest weapons that a person could carry and fire, generally fully automatic machine guns or shoulder mounted rockets and missiles.

Powered Weapons

In microgravity firearms are exceedingly dangerous, and the recoil potentially lethal. In a vacuum, chemical accelerants release a larger more dramatic burst. This led to a resurgence of melee weapons used in space and for ship boarding. Naturally this also means that powered versions of these weapons were developed for increased offensive capability. Powered melee weapons generate energy in addition to the impact damage.

Stun Gun

On a hit, contact capacitors will stun the target until the end of their next turn unless they succeed a DC 13 Constitution saving throw.

Stun-knuckles

On a hit, contact capacitors will stun the target until the end of their next turn unless they succeed a DC 15 Constitution saving throw.

Shock Baton

On a hit, contact capacitors will stun the target until the end of their next turn or for as long as the baton is pressed against the target unless they succeed a DC 15 Constitution saving throw.

Railguns

These super heavy mass drivers fire projectiles and many times the speed of sound. The most powerful, such as the KZM will fire an ultra-dense projectile at a fraction of the speed of light. These devastating weapons have such significant recoil that they can only be fired once per round, regardless of the number of attacks you have.

Weapon Mods

Modern weapons often feature optional modular components that can be attached in order to increase performance or add a property it does not normally have. The credit cost of the mod is added to the weapon's credit mod when the weapon is purchased preassembled.

Aim Assist

Uncommon, Credit mod +2

Energy weapons only. Gyroscopic balancers assure that your aim is true. You are +1 to hit targets in normal range who are surprised or have not moved on their previous.

Ammo

Uncommon, Special

The easiest upgrade to a firearm is to use special ammunition. Ammunition generally comes in three categories: pistol, rifle, and shotgun. Some types of special ammo can only be used with certain weapons. The credit cost of special ammo is the same as regular ammunition for the weapon +1.

Armor Piercing. Pistol and Rifle. AP rounds will ignore 1d6 points of armor rank.

Grenade. Shotgun. Adds Explosive (3m) property, removes threat.

Hollow Point. Pistol. Re-role any damage dice that score a 2 or less.

Reactive. Pistol and Rifle. These rounds chemically react, causing 1d8 corrosive damage on a successful hit and each round thereafter for three rounds.

Smart Rounds. Rifle. These bullets will ignore anything less than full cover.

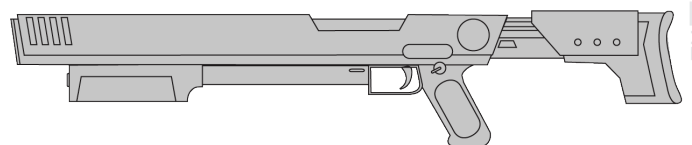
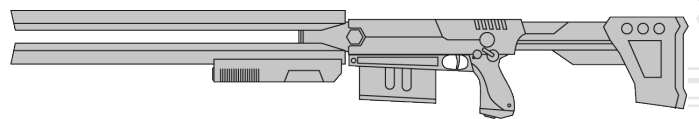
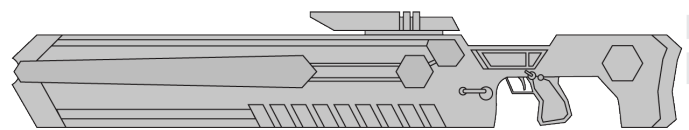
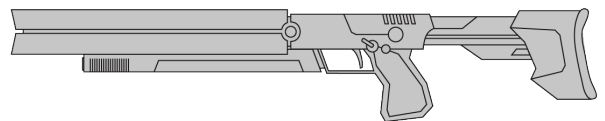
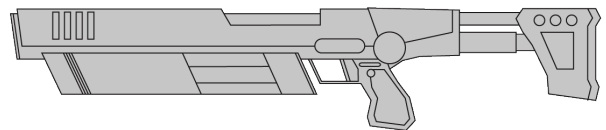
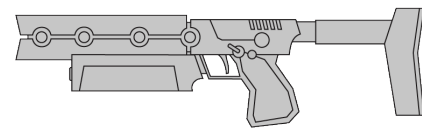
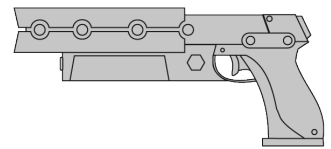
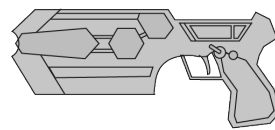
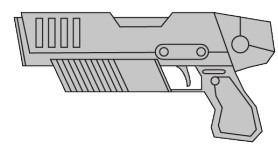
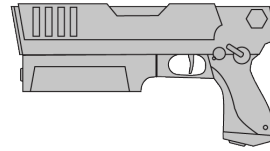
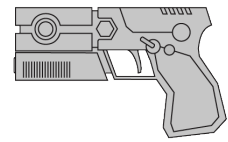
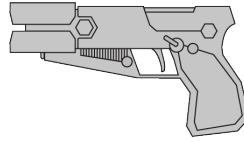

EQUIPMENT & CONTACTS

Tesla. Shotgun. Deals electric damage, on a hit stuns a creature until the end of their next turn. Removes threat.

Thermobaric. Pistol. The bullets become semi-plasma when fired. Deal thermal damage.

Tracer. Rifle and Heavy machine gun. Gain advantage on Burst and Automatic (threat) attacks.

Special ammo also carries a risk. If you roll a natural 1 on your attack roll while firing special ammo, the firearm is damaged, and cannot be used until it is repaired (DC15).

Biometric Lock

Rare, Credit mod +1

You can program the weapon to only function for you and up to three people of your choosing. If others attempt to activate or fire the weapon, it will not respond. This can be attached to Powered Weapons.

Compensator

Common, Credit mod +2

A compensator significantly reduces recoil on semi-automatic weapons increasing the accuracy of rapid successive shots. Burst attacks use one less round of ammunition.

Extended Magazine

Common, Credit mod +2

This is an extra-large clip of ammunition - double ammo capacity. To revolvers or shotguns.

Holo-sights

Uncommon, Credit mod +2

This is an advanced electronic sight which has built in targeting and range finding. Increase normal range by one-quarter, but do not change maximum range.

Multi-optic Scope

Uncommon, Credit mod +3

This powerful electronic scope can see into multiple spectrums to reveal enemies. The scope has Darkvision out to 100m, and thermal vision out to 50m. Targets gain no benefit from partial cover and are at disadvantage to hide from you within that 100m. Powerful magnification increases normal range by one-quarter.

Scope

Common, Credit mod +1

This is a purely optical scope, complete with range finders and guides. Increase normal range by one-quarter, but do not change maximum range.

Secondary weapon

Uncommon, Special

A secondary weapon, such as a bayonet, second gun, laser weapon, or grenade launcher

is attached to your weapon. The second weapon must be smaller than the primary weapon. The cost is the same as the secondary weapon +1, or +2 if it is a powered or energy weapon.

Smart Scope

Rare, Credit mod +2

The most advanced scopes are themselves miniature computers built for imaging and tracking. Smart scopes allow for trajectory and movement calculations increasing maximum range by one quarter. These computers can be networked and used as HUDs for advanced targeting apps.

Suppressor

Uncommon, Credit mod +1

Pistols and Rifles only. A suppressor will cut the light and noise from a weapon considerably and make it harder to detect. From a distance equal to the weapon's normal range Wisdom (perception) check attempts to spot a hidden shooter with a suppressor suffer disadvantage.

EXPLORATION EQUIPMENT

In the thick of action, you never know what you are going to need. Below is an outline of common exploration equipment you might make use of on your adventures.



Exploration Gear

Item	Mass	Credit
Ammunition		
Pistol Cartridge (100)	10kg	+2
Rifle Cartridge (100)	15kg	+3
Shotgun Shell (50)	8.5kg	+1
Heavy Shell (100)	5.5kg	+3
Explosives (10)	5kg	+5
Energy Cell (1)	0.5kg	+4
Plasma Cell (1)	0.75kg	+4
Railgun Canister (1)	2kg	+5
Clothing		
Athletic attire	0.5kg	+2
Business outfit	2kg	+2
Casual outfit	1kg	+1
Formal attire	2kg	+3
Formal uniform	2kg	+3
Harness Vest	0.5kg	+2
Hazmat Suit	3kg	+5
Jumpsuit	1kg	+1
Outfit Accessories		
Costume	--	+2
Fine	--	+3
Exquisite	--	+9
Working overalls	2kg	
Packs		
Backpack	1kg	+1
Duffle bag	1kg	+2
Holster or Scabbard	0.25kg	+1
Messenger Bag	0.25kg	+2
Sealed hardcase	2kg	+3
Tool case	2kg	+3
Tool Belt	0.5kg	+2
Utility Belt	1kg	+2
Reconnaissance gear		
Binoculars	0.25kg	
Optical		+2
Digital		+3
Comms Jammer	0.1kg	+6
Comms Interceptor	0.2kg	+8
Heads Up Display	0.2kg	+4
Micro Tracker	--	+3
Multi-optic Goggles	0.25kg	+5
Survival Gear		
Canteen	0.01kg	+1

Climbing Harness	0.05kg	+2
Diving Gear	5kg	+8
Emergency Vacuum suit	2.5kg	+8
Gasmask	1.5kg	+2
Gyrocompass	0.25kg	+2
LED Floodlight	1kg	+2
LED Torch	2kg	+1
Map	--	+1
Polarized goggles	--	+1
Portable Shelter	10kg	+6
Portable Stove	6kg	+2
Rope (50m)	1.5kg	+1
Tent	1kg	+2
Trail Rations	1kg	+1
Tool and Kits		
Artist's Supplies	12kg	+2
Carpenter's Tools	15kg	+3
Chain (per 3 meters)	4.75kg	+1
Culinary Utensils	4kg	+2
Cutting Torch	2kg	+2
Drone, Sensor	1.1kg	+6
Drone, Repair	2.5kg	+8
Fabrication Tools	15kg	+6
Forensics Kit	2kg	+4
Handtools	8kg	+3
Hunter's Kit	2.5kg	+2
Laboratory	18kg	+5
Make-up Kit		
Cosmetic	0.5kg	+2
Stage Makeup	0.5kg	+3
Med Kit		
First-aid Med kit	1.3kg	+2
Mobile Autodoc	21.5kg	+6
Trauma Patch	0.1kg	+2
Multitool	0.2kg	+2
Musical Instrument	Var.	+2
Repair Kit	8kg	+2
Restraints	2kg	+1
Sample vials	100gr	+1
Security Kit	0.2kg	+2
Specimen containers	0.5kg	+1
Standardized Power Pack	1.5kg	+2
Volatile Chemicals	Var.	+3

Ammunition

Munitions generally comes in cases that are standardized. Energy weapons and railguns use standardized packs that hold a set amount of energy, how many shots a weapon can fire from that canister or cell depends on the power of the weapon.

Clothing

Your wardrobe can make an impression in the arc. Clothing can be custom made or off the rack. Any outfit that is also designed with extra insulation for extreme cold costs +1 credit modifier.

Outfit Accessories

These can include jewelry and watches, hand bags and shoes, or other outfit accessories such as hats, ties, belts and scarves.

Packs

Bags, backpacks and belts aid in carrying and weight distribution. Most Back packs can hold 0.3 cubic meters, messenger bags 0.15 cubic meters, duffle bags around 0.75 cubic meters, and belts can carry up to 8 small sized hand-held objects.

Reconnaissance Gear

Binoculars

Binoculars increase range of vision.

Optical. Purely optical binoculars are low-tech but reliable. Most provide x50 distance magnification.

Digital. Digital binoculars combine powerful optics with onboard augmented reality overlays to show distance, thermal vision out to 100m, and Darkvision out to 1000m with x100 magnification. Targets gain no benefit from partial cover and are as disadvantage to hide from you with in that 1000m

Comms Jammer

This will disable most standard radio signals within 100 meters at full power. And Intelligence (computers) DC 12 check is needed to overcome. This provides advantage on Computers (Jamming) checks.

Comms Interceptor

This can intercept radio frequency communication within 150 meters from standard comms. This device provides advantage on attempts to eavesdrop or listen in to encrypted communications.

Heads Up Display

This device connects to a computer device and provides a real time overlay of data from the device.

Micro Tracker

This miniature RFID tracker has a passive broadcast range of 300 meters and can be tracked with any paired communication devices.

Multi-optic Goggles

Usually built into a helmet, these goggles provide Darkvision out to 15m, and thermal vision out to 10m. Targets gain no benefit from partial cover and are as disadvantage to hide from you with in that 10m. Auto polarization gives you advantage on saving throws against being blinded by flashes of bright light.

Survival Gear

General wilderness and exploration gear.

Canteen

Holds 1 liter of water.

Climbing Harness

Adds advantage on climbing checks with rope and pins.

Diving Gear

Provides 4 hours of air, and a maximum depth of 500m.

Emergency Vacuum suit

Requires 1 full round to don this suit, and provide minimal environmental protection. Immunity to vacuum, 4 hours of air, and advantage on saving throws against radiation.

Gasmask

Active air filtration provides immunity to air-born disease, toxins, poisons, and gasses.

Gyrocompass

Programable device provides orientation based on an initial point. Adds advantage to Constitution (survival) checks to orient and navigate.

LED Floodlight

Provides bright illumination to a code 30m long and 30m wide. Creates dim illumination for another 15 meters.

LED Torch

Creates an area of bright light 10m long and 15 meters wide, and provides dim light for another 10 meters.

Mag Boots

These high-powered magnetic boots will affix to virtually any external vehicle hull and allow movement along the surface as difficult terrain.

Map

This is a detailed map of a specific area, no more than 10km by 10km.

Polarized goggles

Provides advantage on saving throws against being blinded by flashes of bright light.

Portable Shelter

This self-assembling emergency shelter provides a temperature-controlled space for up to three medium sized creatures, or two comfortably. The device will deplete a standard battery pack in 12 hours of use.

Portable Stove

This is a small electric stove. It will deplete a standard battery pack in 8 hours.

Tent

This is a standard tent. Fits 2 medium sized creatures comfortably and can be assembled in about 10 minutes.

Trail Rations

High nutrient, high energy meals ready to eat.

Tool and Kits

Tools and kits are used to perform specific tasks or crafts. Some are simply generalized tools that are commonly useful on your adventures.

Artist's Supplies

These supplies allow you to create works of meaningful art in one medium. Each additional medium is a different toolkit. For example, a painter's supplies are different from a sculptor, or even an autobody painter.

Carpenter's Tools

These are portable tools needed to perform most carpentry and wood working. A full woodworking shop has an additional +2 Credit modifier and requires 4 cubic meters of space to work in.

Chain

This is a 3-meter length of heat-treated grade 70 steel chain.

Culinary Utensils

Portable cooking sets designed for use outdoors or in a limited space. A full kitchen has an additional +2 cost modifier and requires 4 cubic meters of space to work in.

Cutting Torch

A miniaturized plasma cutting torch designed for mobility. Plasma arc burns at 30,000 degrees Celsius, but the cutting area is the size of a needle and only a few centimeters long. Used as a weapon it deals 1d10 thermal damage.

Drones

Tiny machine, unaligned

Armor Class 12 (natural armor)

Armor Rank 13 (+1)

Hit Points 4 (1d6)

Speed Flying 20m.

STR	DEX	CON	INT	WIS	CHA
3 (-4)	12 (+1)	10 (+0)	1 (-5)	8 (-1)	2 (-4)

Senses blindsight 10m, passive Perception 9

Condition Immunities Anxiety, Charmed, Deafened, Exhaustion, Frightened, Poisoned, Provoked, Septicemia, Shock

Languages –

Challenge 0 (15 XP)

Extremophile. Drones can operate in a vacuum and are resistant to radiation damage.

Actions

Slam. Melee Weapon Attack: +1 to hit, reach 1m., one target. Hit: 1 bludgeoning damage.

Drone, Sensor

This 0.3m by 0.3m robotic drone resembles a flying disc with a forward sensor package. You can pair the drone with your computer device and operate it at a range of 1km. The sensor drone is equipped with multi-optics that have Darkvision and thermal vision to a range of 10m and can make audio visual recordings. Samplers and sensors allow for an Intelligence (science) check made at range.

Drone, Repair

A repair drone can operate at a range of 250m from a controller and is equipped with multitools and manipulators to affect repairs via a Repair kit or Intelligence (engineering) check.

A repair drone's tools can be used to attack for 1d8 Thermal damage or 1d4 slashing damage.



EQUIPMENT & CONTACTS

Fabrication Tools

This mobile toolset allows for the shaping and fabrication of many small parts and components. A full Fabrication facility that can construct large parts for heavy machines had an additional +2 credit modifier and requires 10 cubic meters of space (at least) to operate.

Forensics Kit

This set of tools can be used to gather evidence from a crime scene such as prints, residual genetic material, microscopic material remnants, recovered ballistics and so on, to aid with investigation. Combined with a Lab, you can examine the evidence in detail to draw conclusions.

Handtools

General non-powered hands tools such as wrenches, hammers, screw drivers, and pliers.

Hunter's Kit

This set of traps and cords can be used to capture most medium sized game. A collection of knives and hooks can be used to skin and disembowel creatures.

Laboratory

A set of analytical and miniature production equipment to investigate substances and chemicals, as well as glassware and tools to synthesize simple chemical compounds and produce small amounts of exotic materials. A full laboratory for a specific science has an additional credit modifier cost of +2 and requires 10 cubic meters of space to operate.

Make-up Kit

Used to alter appearance.

Stage Make-up. Includes prosthetics and components to radically alter your appearance to be younger or older or of a different humanoid race or alien ethnic group. These semi living applications can hold up to moderate inspection, such as an Intelligence (investigation) check, and can fool all but the most sophisticated scanning equipment.

Cosmetic. Purely to increase aesthetic appeal.

Med Kit

A complete kit needed to treat injuries and many common illnesses and stabilize the dying.

First-aid Med kit. This small kit contains sutures, bandages, gauss, and antiseptics as well as general ant-toxins to treat poisoned condition (4), trauma patches to treat injuries and wounds (4), and diagnostic sensors that can be paired with a computer to detect and identify serious injuries.

Mobile Autodoc. This is a mini-surgical kit complete with advance robotic assistants and

diagnostic systems that can treat and forestall serious injury and death. It contains 10 trauma patches and 10 doses of anti-poison.

Trauma Patch. This is a single gel patch designed to match a patient's biochemistry to quickly close wounds, generate additional platelets, disinfect, and ease pain. A trauma patch can restore 2d4+2 hit points to a creature with at least 1 hit point. Instead of recovering hit points a Trauma Patch can be used to stabilize a creature in microgravity.

Multitool

This small handheld device can be used to perform as many tools.

Musical Instrument

This is a portable musical instrument. Large and immobile instruments such as a grand piano or organ have an additional +2 credit modifier.

Repair Kit

A combination of multi-tool, spare components, and moldable poly-alloy can affect most small to medium repairs. A repair kit is functionally exhausted after repairing 40 hit points to machines.

Restraints

These high-strength restraints can hold a medium sized creature. A DC 30 Strength check is required to break-free of the manacles.

Sample vials

Sterile 10 to 200 milliliter glass sample containers.

Security Kit

This is a collection of tools necessary for lock picking and mechanical bypass.

Specimen Containers

Small plastic containers for containing living specimens of small size or smaller.

Standardized Power Pack

A lithium-helium-graphene super capacitor with a smart adapter to match watt and amp needs of most high-power consumer electronics.

Volatile Chemicals

Generally, any simple base or acid, or low radioactive chemicals, and other compounds necessary to synthesize more complex and dangerous chemical compounds.

COMPUTERS

Information technology is impossible to escape it seems. The Arc is a connected civilization, with billions of quantum nodes and satellites connecting planets and cultures across a

nearly unified communication grid called the Astral Network. Computers are also one of the most important tools to high tech adventures; computers can store information, process data, analyze the environment, and assist in any number of tasks.

Regardless of the formfactor or other characteristics, all computers share the following properties and capabilities:

- **Biometric Lock.** A computer device can be restricted to up to 3 people through complex biometric locking. A DC 15 Hacking check is needed to by-pass this lock.
- **Interface.** All computers have a screen to display information and an interface to give the device commands. This could be a touch screen as is the case with most mobiles and tablets, or a physical keyboard and pointer as will many tablets and terminals.
- **Storage.** Computers can store practically unlimited amounts of information as text and documents, and hundreds of hours of video and audio. For practical game purposes no device has a storage capacity of every day data. Exceptionally rare or unique data such as a true AI's consciousness or the Archives of a long dead alien race might exceed a mobile or tablets resources though.
- **Wireless.** All computers are designed to generally communicate with other computers within 10 meters through wireless signals. A DC 10 Intelligence (computers) check can network a party's computers.

Computer Proficiency. You might be called upon to make an Intelligence (computers) check to make use of your computer devices. Proficiency in computers allows you to not only use, but assemble, repair, program, and maybe even hack computers you encounter.

Mobile. This is a small hand held, or body/arm mounted computer device that can be easily concealed and carried. While mobile devices are not exceptionally powerful, they are versatile and ubiquitous.

Tablet. Powerful but portable, Tablet style computers are commonly used for both work and entertainment, and can run many of the apps needed to perform work such as engineering, sciences, and art.

Terminals. These are enormous and powerful computers such as those necessary to operate starships and calculate Horizon Drive courses. Terminals are very powerful and can use a huge number of apps concurrently but are not at all portable.

Power. This number represents the general power of the device, which dictates the number

of apps it can run. Apps require a certain amount of power to run on a device, and while an app is active, it consumes that much of the device's resources. For example, a device with 5 power could run an app which required 2 power, and another which required 3 simultaneously, but could only run one app which required 5 power.

Computer Properties

Astral. Any computer with the Astral property has been issued an AstralNet address and can connect to the interstellar network of the Arc.

Camera. The Device features an audiovisual recording device capable of taking pictures and recording video, audio, or both.

Comms. A computer with the comms property can connect to most standard wireless communications mesh networks.

Ident. A device with an Ident control can act as ID and payment controller.

Scanner. The device has a powerful multispectral scanner. With a successful DC 13 Intelligence (computers) check, you can gather one of the following pieces of information.

- High resolution infrared and ultraviolet imaging x10 magnification.
- Analysis of the atmosphere and meteorological conditions within 1km.
- Number and estimates out-put of energy sources or energy fields within 10m.
- Analysis of the chemical composition of the surface of an object within 3m.

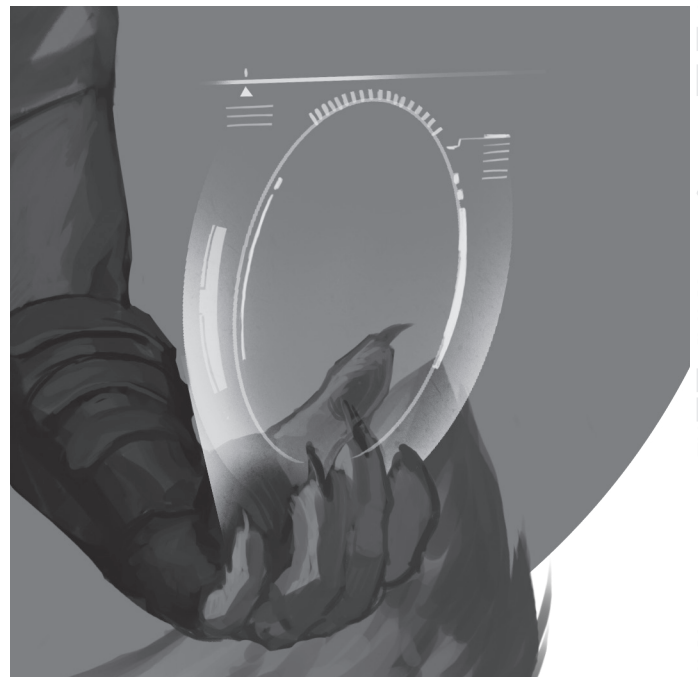

EQUIPMENT & CONTACTS

Computers

Device	Pw.	Credit Modifier	Mass	Features
Mobiles				
Simple Communicator	2	+ 2 universal	0.1kg	Camera, comms
Maxi Communicator	5	+ 4 common	0.2kg	Camera, comms, ident
Computer Gauntlet	5	+ 7 uncommon	0.4kg	Comms, ident, Special
Astral Communicator	4	+ 8 uncommon	0.2kg	Astral, camera, comms, ident
Tablets				
Personal Tab	5	+ 3 common	0.4kg	Comms, ident
Professional Tab	6	+ 4 common	0.6kg	Camera, comms, ident
Mobile Lab Device	6	+ 6 uncommon	1kg	Comms, Scanner
Astral Access Point	5	+ 8 uncommon	1kg	Astral, Comms, Ident
Terminals				
Workstation	10	+ 5 common	4kg	Special
Ship's Main Systems	15	+ 9 uncommon	50kg	Astral, Comms
Thinker	-	+36 restricted	500kg	Special

Mobiles

A miniaturized computer and communication device that virtually every civilization developed after a fashion. Most mobile devices have a rugged case and simple interface scheme. A mobile device is usually 135 millimeters by 70 millimeters with slate formfactor, but not always.

Computer Gauntlet

Designed to be built into armor, computer gauntlets usually feature a holo-display and interface, and either have a Scanner, Camera, or if neither of these features, +1 power.

Tablets

Besides mobiles, this is the most common personal computer in the Arc, most citizens carry a tablet with them every day. Most tablets are slate devices measuring 230 millimeters by 100 millimeters. Many Tablets feature a grip, rugged case, or holo-interface.

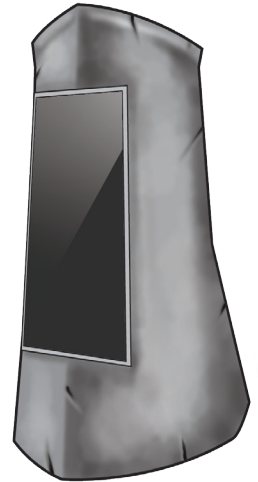

Terminals

Large powerful workstations are usually reserved for very heavy computing. Modern terminals are so powerful that they are only ever really used when performing quantum calculations or for AI research.

Thinker

This is a kind of self-aware general AI used for controlling ships, factories, or other large site installations. While thinkers can emulate many apps, they cannot run them natively, instead they have real intelligence and skill proficiencies.

The average Thinker has an Intelligence core of 16, Wisdom score of 6, and a Charisma of 8. Thinkers are programmed with proficiency in one or two languages, Computers, and one skill check and has 2 or 3 of the specialties under that skill.

In most other respects a thinker can act as an incredibly efficient and capable AI assistant. Upon command that can provide their proficiency and knowledge, access information, and command connected systems.

Astral Connection

Across the Arc worlds and outposts are connected by a nearly instantaneous quantum communication and data transmission grid known as the Astral Network. An acronym for asynchronous stellar transmission relay access layer, astral is a complex mesh of quantum computer nodes and repeaters which makes up the backbone of galactic communication. With access, you can contact virtually anyone in the galaxy - provided they have access and they are part of your networks or you have their direct contact information.

Any terminal or mobile device with astral connection can access the astral network, and there is no check to perform mundane tasks such as checking communications or searching basic information. If you want to perform complicated searches, or access restricted information you must make a suitable Intelligence (computers) check. The DC of this check depends on the scope of the task, as outlined below.

Activity	DC
Find encyclopedic entry on a subject	10
Find a tutorial for a common craft	10
Locate personal background information	15
Access highly restricted training material	15
Use the darknet engage in cyber-crime	20

Hacking

With the Hacking specialty, you can access restricted or protected computers through a variety of attack vectors, and create malicious software to perform a task, such as collecting information or damaging systems.

You can also use Hacking to penetrate secured networks that are connected to the Astral. The security on the network dictates the DC, but it generally the value and scope of information you can find is much higher; personal private information, damaging secrets, research and data on cutting edge technology, and more.

Hacking through the astral is dangerous, as every access point is unique and has a unique address, making it hard to remain anonymous while connected to other systems. The most sensitive and secured networks are usually not connected to the astral and are only accessible via physical connection.

Apps

Much like Mods extend and modify the functionality of weapons, armor, and vehicles, Apps are application extensions that provide

abilities and bonuses to the user of a computer. Apps have a credit mod of +0.

AI Assistant

Power Cost: 3

An AI assistant is a general-purpose intelligence that can answer basic queries, access basic information or apps on the device, and perform many of the basic functions of the computer for the user through voice or other command. In practical terms, you can command the AI assistant to do anything that you could do through your computer such as turn connected devices on or off, access media, or even start up a connected machine or device. Anything that would require an ability check is beyond the assistant.

Appraiser

Power Cost: 2

An Appraiser app can use a camera or scanner to identify the make and model and provide an estimated market value of virtually all consumer goods that are universal, common, uncommon, or rare, including most weapons and armor.

ControlHack

Power Cost: 5

This is a highly illegal suite of programs designed to maliciously seize control of another device remotely. To use this app, you must make a DC 15 Hacking check, and have some means to connect to the target device remotely.

Device Scanner

Power Cost: 1

This app will ping all the local wireless signals and give you a map of nearby devices within 10 meters.

Drone Control

Power Cost: 3

This app will hook up to one Drone and allow for remote control of the drone at the range of it and the computer's wireless signal.

Entertainment App

Power Cost: 4

This is a high definition interactive entertainment app, such as an immersive holostreaming service or gaming service. Great way to spend your down time between adventures.

Optical Scan

Power Cost: 3

Multi-spectral scanners are expensive, but most consumer cameras can detect a wide electromagnetic wavelength. This app makes use of a camera to scan a broad range of

EQUIPMENT & CONTACTS

electromagnetic spectra, providing a +2 bonus on Wisdom (perception) checks to detect hidden or camouflaged creatures or objects.

Ship Uplink

Power Cost: 1

This app allows you to directly communicate with and control a ship that has been paired to the device. Most ships allow multiple uplinks, but most devices only support one ship uplink. The device must generally be inside the ship or within 30 meters.

SkillKit

Power Cost: 4

This app features a modified AI assistant that is specialized in one of the following areas: Sciences, Engineering, History, Medicine, or Insight. On your turn before your action you may use your bonus action to make a DC 10 Intelligence (computers) check to access this specialized assistant. With a successful check, the AI provides you Aid on your next appropriate skill check.

Targeting App

Power Cost: 3

Usually built into computer gauntlets, a targeting app can quickly use a connected HUD from a helmet, smart scope, or cybernetic eye to augment weapon targeting. This app provides a + 1 bonus to hit with ranged weapons in normal range.

VEHICLES

Chances are you will spend a lot of time in vehicles, be it traversing a planet's surface, exploring a derelict station, or simply cursing in the city, you won't be traveling hundreds of kilometers on foot. This also means you will be fighting, resting, and adventuring in your favorite mode of transport.

Regardless of the basic chassis or modifications, all vehicles share the following features:

- Biometric Lock that identifies one owner
- Console displays for speed and remaining range
- Electric motors and batteries
- Onboard AV system and control computer with wireless uplink
- Onboard systems information which displays the general condition of the vehicle

Vehicle Proficiency. When you are proficient in Vehicles you can operate virtually all the surface, nautical, and hover vehicles outlined below. You add your proficiency check to rolls to perform



maneuvers with vehicles, and you can perform basic repairs with a successful Intelligence (engineering) check. To fly an aircraft, you must have proficiency on the Piloting skill and the Atmospheric piloting specialty.

Armor Class. Each vehicle has a base armor class, this is both how hard it is to hit and damage. Some operators can add their proficiency bonus to their vehicle's Armor Class.

Hit Points. Vehicles have hit points like characters. When your vehicle's hit points reach zero it is disabled. Damage control and repairs are needed to keep it from being destroyed.

Range. How far the vehicle's energy reserves can take it, whether it is electric or powered by chemical fuel. As a note internal combustion engine do not operate in a vacuum so any chemically fueled vehicle is inert in space or a planet with no atmosphere.

Size. All vehicles fall in one of the normal size categories.

Seats. Vehicles can only carry so many people comfortably and safely, this is the max occupancy.

Cargo. This is the maximum mass of cargo the vehicle can carry. Surface and nautical vehicles can tow ten times their cargo capacity.

Vehicle Properties

Off Road. A surface vehicle with this property ignores difficult terrain for overland travel and can move through most rugged environments with relative ease.

Tow Hitch. A vehicle with a tow hitch can tow a wheeled or floating weight of 20 times the cargo capacity.

Hover. This vehicle can hover in combat.

Surface Vehicles

Cars, trucks, and rovers of all kinds are surface vehicles designed to ride along a planet (or other celestial body's) surface. Surface vehicles are generally propelled via wheels or treads and are powered by electric engines.

Surface vehicles have low maneuverability.

Vehicles

Vehicle	AC	HPs	Seats	Credit Modifier	Cargo	Range	Speed	Size	Properties
Surface									
Motorcycle	8	40	1	+4 common	50kg	800km	250km/h	Medium	
Sedan	11	60	5	+8 common	200kg		200km/h	Large	
Truck	11	70	2	+8 common	1000kg		175km/h	Large	Tow Hitch
Sports Car	10	55	2	+12 common	100kg	500km	325km/h	Large	
All-Terrain Rover	11	80	6	+10 uncommon	800kg		125km/h	Huge	Off-Road
Armored Carrier	14	250	10	+15 restricted	2000kg	500km	150km/h	Gar.	Off-Road, Tow Hitch
Nautical									
Jetski	8	35	2	+2 common	30kg	200km	125km/h	Medium	
Bass Boat	10	50	4	+2 common	100kg	350km	175km/h	Large	
Jet Boat	10	60	4	+8 uncommon	150kg	700km	250km/h	Huge	
Yacht	12	120	12	+15 uncommon	2000kg		175km/h	Gar.	
Mini Submersible	11	40	1	+15 rare	45kg	150km	85km/h	Medium	Special
Hover									
Hovercycle	8	40	2	+13 rare	25kg	175km	250km/h	Medium	Hover
Hovercar	11	60	4	+16 uncommon	75kg	300km	300km/h	Large	Hover
Jetcar	10	60	2	+16 rare	75kg		550km/h	Large	Hover
Hoverbarge	12	120	12	+22 uncommon	3000kg		150km/h	Gar.	Hover
Hover Tank	14	250	4	+30 restricted	200kg	250km	200km/h	Huge	Hover
Aircraft									
Personal Jet	10	60	3	+25 uncommon	50kg		750km/h	Huge	Hover
Passenger Jet	12	120	14	+30 rare	800kg		2500km/h	Gar.	
Jet Fighter	12	100	2	+35 restricted	75kg		3000km/h	Huge	

Nautical Vehicles

Boats, jet-skis, and submersibles are all examples of nautical vehicles. Generally, only the very large ships and sail-boats operate radically differently than most surface vehicles. Otherwise, hover and nautical vehicles handle almost the same.

Nautical vehicles have low maneuverability.

Mini Submersible

This is a miniature highspeed sub. The surface speed of the craft is 125km/h. The maximum depth is 150 Meters, and the craft has environmental systems for 3 hours of sustained dive.

Hover Vehicles

With the development of electromagnetic propulsion, small scalable hover technology allows for high speed vehicles that operate

somewhere between surface vehicles and aircraft. Most have an altitude ceiling of about 10 meters and operate similarly to most nautical craft.

Hover vehicles have medium maneuverability.

Aircraft

Planes, jets, and even exotic high-altitude hover vehicles. Aircraft are designed to operate in an atmosphere, at altitude. To use Aircraft, you must have proficiency in the atmospheric piloting specialty. An aircraft that is capable of hovering is capable of vertical takeoff and landing.

Aircraft have medium maneuverability.

Mods

Vehicle mods are customizations that add functionality or features to a base vehicle type. Most consumer vehicles are sold with a selection of mods, but you can purchase them separately and install them with a DC 15 Intelligence (engineering) check.

Advanced biometric locks

The vehicle can be programmed with up to 4 identities to unlock and activate.

Armored

Heavy armored plating and damage resistant glass give the vehicle +2 to Armor Class and half again as many hit points. However, the armor takes up one quarter of the vehicle's cargo capacity.

Auto-pilot

The Computerized system of the vehicle is equipped with an auto pilot function that can generally maintain a course and speed, or navigate towards a destination. If a sensor package is installed the vehicle is capable of fully autonomous travel and can be summoned to a paired device if it is within range.

Environmental

The cabin can be sealed and pressurized, allowing for 3 hours of life-support and protecting the occupants against external toxins or gasses.

Extended range

Additional banks of batteries add for additional range at the expense of cargo capacity. This mod increases the vehicle's range by one half, but takes up one quarter of the vehicle's cargo capacity.

Luxury Package

The vehicle comes with finest trim and comforts, the very essence of luxury.

Multi-mode

A multi-mode mod essentially combines two vehicles. Examples include amphibious cars, seat to air jets, and equipping standard vehicles with hover capability. This functions by combining a vehicle of the same size with the vehicle you are modifying with this feature. The second mode has the speed, range, and properties of the selected secondary vehicle, but the AC, hit points, and seats of the first vehicle. Only a vehicle of a different category can be used as the second mode. The second mode consumes half of the available cargo space.

Off-Road Kit

This equips a surface vehicle with an off-roading kit so that it can operate in difficult terrain.

Overdrive

The vehicle is equipped with a super charged capacitor that can push the electric engines to the extreme but at greatly increased power consumption. Pushing the vehicle in to overdrive consume 2km of range for each 1km traveled, however max speed is increased by half.

Sensor Systems

This package of sensor systems includes a passive radar, active lidar, and thermal imaging displayed on the vehicle's HUD. Using the sensors, you can determine the speed and position of other objects within 1 km, as well as gain a +1 bonus to Wisdom (perception) checks while in the vehicle.

Solar Charger

A back up power supply, the solar charger allows the vehicle to recharge its range while exposed to bright sunlight. Each hour exposed to bright sunlight will recharge 10km of range. The vehicle cannot be running while charging.

Tow-Hitch

This adds the tow-hitch property to a surface or nautical vehicle, increasing its towing capacity.

Uplink

With this mod, the onboard computer can be linked to one paired device which can remotely activate the vehicle, lock or unlock the doors, or activate onboard systems such as vehicles.

Weapons Mount

The vehicle has an external weapons mount that can support a firearm or energy weapon. The weapon requires its own ammunition but can have its own modes. Each weapon mount takes 2kg of cargo space, plus the mass of the weapon.

SERVICES AND PERMITS

Adventurers will often find that they need to purchase the services of another more skilled expert, or purchase that required permits or licenses to Engauge in certain activities.



Service	Credit Modifier
Civil License	+2 uncommon
Medical Aid	+4 uncommon
Military Contractor License	+8 rare
Passport	+2 common
Psychiatric Aid	+3 common
Repairs, General	+2 common
Repairs, Ship.	+3 uncommon
Transport - planetary	+1 common
Transport - interplanetary	+2 common
Transport - interstellar	+6 uncommon

Civil License. You have attained a civil license which allows you to practice a regulated trade, such as a license to practice medicine, law, or psychology. More exotic licenses can include a bounty hunter's license, private investigator license, or even a trade union engineering license. Regardless, if you choose you can practice this profession legally during down time, or rest on your license during integrations, such as gaining access to a trade show, restricted medical center, or similar. Generally maintaining a license like this requires regularly practicing this skill and renewing the license periodically.

Medical Aid. Non-emergency medical care for illness and injury. A staff of trained medical professionals in a modern clinic can heal wounds and aid in recovery. Add +2 Credit modifier for emergency care to stabilize a dying person, or +4 for an emergency medical evacuation where available.

Military Contractor License. This is functionally a mercenary license recognized by one of the major factions. These are relatively easy to acquire but require expensive upkeep. With the License you can purchase restricted military goods.

Passport. A Passport issued and recognized by most major powers, while this won't prevent you from being stopped at a port of entry for any number of reasons, it will give you legal right of passage in those cases.

Psychiatric Aid. Regular therapy session can help prevent or diminish antipathy and overcome or treat mental illness. This is the cost for a month of weekly therapy sessions with a skilled professional.

Repairs, General. Repair services for most common equipment, weapons, armor and computers.

Repairs, Ship. This is the cost for dry-docking a ship for repairs and refuel. Repairs will recover all hit points if above half and 3/4 of damage if the ship is below half hit points.

Transport. This is the cost to book transport aboard a ship or other method of mass transit. Interstellar transport is generally per trip of 50 light years or less. Longer trips might cost an additional amount based on distance.

LIVING EXPENSES

Adventure will take you to the corners of the Arc, to alien worlds, and to the depths of space. Between these expeditions, even the most intrepid will face certain realities and expenses. Housing, food and drink, fuel, service subscriptions, and clothing all cost some money to maintain and can affect your Credit.

Cost of Living

Your cost of living depends on your lifestyle, Credit, and expenses. Even in the distant future of Advent Horizon adventurers still must pay for the essentials of survival and to maintain their equipment between sorties. The general upkeep is required even when you are living aboard a ship or station.

Your lifestyle can have an impact on your reputation, as well. Living opulently, even while it may drain your Credit, may provide you access to contacts and connections you could not have otherwise had the opportunity to encounter. Conversely, being well known for your frugality or living like a vagabond may make you a less appealing target for those who would want to exploit your resources, but people may not take you seriously either.

The lifestyle you can maintain without concern is set by your Credit modifier. You can also choose to live a more frugally or choose to live opulently. At the beginning of each month you must choose your standard of living, which will impact the associated cost. If you choose to live above or below your means you may potentially gain Credit or lose it, as describe on the table below.

So long as your Credit meets or exceeds the minimum Credit modifier for that lifestyle, you can maintain it without worry or risk. Attempting to maintain a lifestyle higher than your Credit will result in a -1 cost to your Credit modifier for each class above your available standard of living at the end of the month. Should you choose to live a frugal life, at a life style at least one category lower than what you can afford, you will gain +1 Credit at the end of that month, reflected in savings.

Lifestyle Cost

Lifestyle	Credit
Wretched	+0
Squalid	+2
Poor	+4
Modest	+8
Comfortable	+15
Wealthy	+30
Aristocratic	+50 or more

Wretched. You live as a vagrant and itinerate scavenger. You have no home, you shelter wherever you can; under structures such as bridges, empty shipping containers, or abandoned buildings. Living this way is miserable and dangerous, you face constant violence, disease, and hunger. Others forced to live a wretched lifestyle will covet your weapons, tools, and adventuring gear. These represent a small fortune by their standards. You are beneath the notice of most people and have Disadvantage on reputation checks with strangers while you live this lifestyle.

Squalid. You board in the slums and ghettos. While you have food and shelter, these areas are often riddled with violence, drugs, and crime. This life style is rarely intentional and reserved for second class citizens and persona non grata in a community, such as oppressed minorities indentured servants. You will not have private transportation or communication at your disposal unless it is stolen or illicit in some other way. You have Disadvantage on Reputation checks with anyone who regularly lives a Modest or better lifestyle.

Poor. This lifestyle is often associated with the 'simple life' rather than abject poverty in an advanced society. You make do with a simple housing in rural areas or in the slums of major cities, survive on simple food, and have few legal protections. You forgo any luxury in exchange for the guarantee of stable housing and sustenance, relying on services like public transit and welfare programs. Your private transportation and communication are likely in poor condition. Sadly, this represents most people's lifestyle throughout the galaxy.

Modest. A middle-class life, one with rented or leased property, perhaps even owning a small condo in a poorer neighborhood. You likely have some means of personal transport and private communications subscriptions. However, you must be conscientious of your use of these resources. You can keep your equipment in good repair. You want for little in way of basic

needs, but cannot afford nicer clothing or foods, and such luxuries are marked by very special occasions.

Comfortable. Living comfortably means having access to specialized food and diet, fine designer clothing and streetwear, and well-maintained weapons and equipment. You likely own a private residence or lease a fine residence in a metropolitan area and have no worries about using your private transportation and communication. Most business people, traders, officers, and scientists live comfortably, and as such, would take you seriously. You are likely afforded many legal protections and recourses in the case of an emergency.

Wealthy. This is a life of luxury, one with few worries for daily needs or use of resources and services. In fact, the serious worries you have may be in managing your wealth. In addition to a fine residence or two modest residences, you have luxury private transportation and communication. You also likely have a portfolio of corporate stocks and investments. Living this lifestyle will likely get you invited to corporate and political events, as well as make you a person of interest in business. While you live this life style, you may reroll any Credit checks you attempt to credit which roll a 1 or a 2.

Aristocratic. The opulence of this lifestyle is degrees higher than wealthy. You likely have multiple estates, and small fleet of private vehicles, and the finest food and clothing. Servants attending to your every need, and act as you proxy to carry out any number of tasks. Your adventuring equipment is in peak condition. You receive preferential treatment from the authorities and will often spend your evenings in the company of the rich and powerful elite. Corporate moguls, politicians, and nobility will know of you if you haven't met yet, and they would be interested in meeting. But this comes with the danger of political and corporate maneuverings. Lies, deceit, conspiracies, and plots whirl around your social circles, and you cannot avoid them. Every month you can maintain this Lifestyle you gain +1 reputation.



Self-Sufficiency

Cost of Living assumes that between adventures you live in a city or station, making use of the goods and services of the community at large. But this is not the only choice available to characters. Some might prefer to live away from civilization, hunting, foraging, and repairing their own gear. Other might live aboard their own ship and have no reason to stay in one place too long. Others might work a day-job between adventures.

Living Rough. This is only possible in undeveloped wilderness. You live off the land, hunting and harvesting. While this has no cost, it is time consuming, there is little or no time for research practice, or preparation. All spare time is spent ensuring survival. Anyone can maintain a Poor lifestyle this way.

Shipboard. Owning your own interstellar yacht means your cost of living is associated with the maintenance of your vessel and considered in the lifestyles above.

Working. If you spend your time between adventures practicing a profession, you can eke out the equivalent of a poor lifestyle with no cost, or a modest lifestyle at $\frac{1}{2}$ the regular minimum Credit.

CONTACTS AND CONNECTIONS

In Advent Horizon, adventurers will make use of a lot more than their money and guns to get things done. Using your Reputation, you will forge and leverage your contacts and connections. Contacts and Connections fall into one of the following categories: Black Market, Corporate, Criminal, Government, Military, and Underworld. Each represents a specific sphere of influence for that contact or connection.

Black Market. These contacts and connections are part of an illicit trade group that crosses the Arc. This collection of smugglers, fences, and enterprising sources move goods throughout the galaxy in defiance of the laws and regulations of trade. From luxury goods to arms and armor, the Black-Market is an intricate organization which will endeavor to move anything anywhere - after all supply and demand are the backbones of commerce.

Corporate. With a contact or connection of this category you have an in with the mega corporations of the colonies. Generally, a corporate contact won't engage in activities that could jeopardize their position in the corporate hierarchy, but will do everything in their power, illegal or not, to elevate their position and power.



Criminal. A criminal contact is one steeped in the most dangerous and vile elements of the Arc. Criminal connections and contacts might provide any number of services or goods, but will be hard pressed to risk getting caught, and if there is any risk that someone who could indict them is around might turn extremely violent.

Government. This category of contact or connection is tied to the operations of the major powers in the Arc, be it a regional or planetary government, the Imperium of Earth, or the Magisterium. This could be a government clerk, a politician or represent a license or permit. Regardless, this contact or connection is backed by the rule of law.

Military. When a contact or connection falls into this category it is part of the military industrial complex of one of the major powers. A military officer, a requisitions officer, or a paramilitary license are examples of this type of contact or connection. While these contacts may be more willing to bend the rules than other legitimate connections, they are still beholden to their military authority and regulations.

Underworld. Operating in the legal grey areas, Underworld contacts and connections are paramilitary by nature. While not strictly illegal, they are shady and questionable. Corrupt officials or police, escorts and pawn brokers, information traders and fake papers are all examples of underworld contacts and connections. In the Underworld, money is the common language.

Who you Know

Once you have acquired a contact or connection, you can leverage that resource whenever you need, so long as you can reach them in some manner. For example, the underground Cyberdoc will install your Cyber mods no questions asked, a corporate middle manager can leak confidential information to you or get you on a corporate frigate, members of your secret fraternity might be willing to send you a rescue ship, and your old military comrades might be willing to show up to the right gun-fight.

Generally, your contacts and connections are not adventurers, and whether they are not willing to fight or die for you or put their lives on the line at all depends on you. If you work to build their loyalty and trust, your contacts and connections will respond in kind. If you treat them like tools you can expect them to sell you out. They are willing to help you when other may turn you away and may even be willing to take some risks in doing so, but that does not make them hired guns you can point at your problems to make them vanish.



Level of Connection

All contacts and connections have a level associated with them, from 1 to 3. Level 1 connections have very limited scope, whereas level 3 contacts have access, privilege, and power. In the description of each it will outline the benefits of a contact or connection of that level.

With the GM's permission you can attempt to upgrade an existing contact or connection by making the requisite reputation check. Sometimes this makes no sense, if the connection in question just cannot be that powerful. However, they might know someone who is, thus opening the doors for you to find and gain new contacts or connections.

Contacts and Connections

Handlers. This is a Corporate, Government, or Military Contact. A handler is a member of some authority with the dispensation to provide you with legal work. This could include transporting goods, investigating incidents, retrieving salvage, or rescuing personnel. Regardless the Objectives will be clearly defined, as will the methods that can be used. Whatever the job, it will pay well and be considered legally sanctioned by most authorities in the Arc.

Level 1. Provide small jobs that can provide +1 d4 Credit up to once per month.

Level 2. Provide significant jobs that offer +1 d8 Credit and +1 d4 reputation up to once per month.

Level 3. Provide critical jobs that offer +2d4 Credit and +1 d6 reputation up to once per month. When a job is accepted, they can provide access to restricted goods of their category.

Brokers. This is an Underworld or Criminal contact. Brokers act as a go between for illicit dealings that are illegal or of questionable intent. When some group or organization needs someone assassinated, something smuggled, or something stolen, they will find talent through a broker. Most jobs that a broker can find for you are intentionally anonymized and criminal or highly suspect.

Level 1. Hook up small gigs that can provide +1 d4 reputation and +1 Credit up to once per month.

Level 2. Hook up elite gigs that offer +1 d6 reputation and +1 d4 Credit up to once per month.

Level 3. Hook up legendary gigs that offer +2d4 reputation and +1 d6 Credit up to once per month. When a job is accepted, they can provide access to restricted goods of their category.

Fences. This is an Underworld or Black-Market contact. This is a merchant who is more than willing to buy goods that might be, technically, someone else's - such as stolen and looted gear.

Having a fence contact means you can regularly sell questionable loot at one-third its Credit modifier. What they can purchase and for how much depends on their level.

Level 1. Move goods up to Credit modifier +6, no restricted goods.

Level 2. Move goods up to Credit modifier +24, and restricted goods of their category.

Level 3. Move goods of any Credit modifier, including restricted goods of their category, and other restricted goods up to Credit modifier +24.

Informants. This is a Government, Corporate, Military, Criminal, or Underworld contact. Within the context of their organization, an informant can provide you with valuable information and clues to aid you in your adventures. A government contract might be able to alert you of new security checks at the docks, and Corporate contact might be willing to tell you about recent ventures the company has made, and an underworld contact might be able to point you towards shady hang-outs for mercenaries. So long as it is within the scope of their affiliations, your informant will probably be in the know.

Level 1. Provide a +2 bonus to relevant Intelligence (investigation) checks.

Level 2. Provide a +2 bonus to relevant Intelligence (investigation) and (bureaucracy) checks.

Level 3. Provide a +2 bonus to relevant Intelligence (investigation) and (bureaucracy) checks. Provides a +2 Reputation bonus on relevant reputation checks to call in favors by "name dropping" the contact.

Smugglers. This is a Criminal or Underworld contact. Through a Smuggler you can procure goods that would normally be unavailable. As a Criminal contact you can acquire Illegal restricted goods from the smuggler. As an Underworld contact you can acquire items with Planetary Restriction or Corporate Restriction. This does not change the cost of the goods but insures you have a reliable source for goods with the appropriate restrictions.

Level 1. Provide goods up to total Credit modifier +16.

Level 2. Provide goods of any Credit modifier, and restricted goods of other categories up to total Credit modifier +24.

Level 3. Provide goods of any Credit modifier of their category at no additional cost, and other restricted goods up to Credit modifier +24.

Specialists. This contact or connection can be of any category. A specialist is proficient in one skill or specialty at expert level. An underworld surgeon, a corporate mechanic, a reputed scholar, and an elite criminal hacker are



all examples of specialists. A specialist has one skill proficiency, and one specialty from that skill which they can provide you with. Your specialist can provide you with their expertise at little or no cost under most circumstances. However, if doing you a favor is risky or dangerous, they may demand payment or refuse to help.

Level 1. Their total skill bonus is +8 in the specialist skill.

Level 2. Their total skill bonus is +12 in the specialist skill, and they possess 1 additional specialty under the parent skill.

Level 3. Their total skill bonus is +16 in the specialist skill, and they possess 2 additional specialties under the parent skill.

Black Marketeer. This is a black market connection. With this connection you are an active member of the Black Market, a shady underground network of merchants and smugglers who ensure that goods continue to move throughout the arc. You do not pay the Restriction availability cost modifier for goods, when you buy from your connections, but you are expected to move goods. This means buying and selling to other black marketeers, selling to clients sent your way by other members of the market, and smuggling goods from time to time.

Level 1. You do not add the restricted cost modifier when buying restricted goods from smugglers but must sell at least +3 Credit modifier worth of restricted or illegal goods to a fence per month.

Level 2. You do not add the restricted cost modifier when buying restricted goods as you work through your network but must sell at least

EQUIPMENT & CONTACTS

+8 Credit modifier worth of restricted or illegal goods to your network per month.

Level 3. Restricted goods of all kinds are available to you in any large port at no additional cost, but you are expected to resell most or all of these good (plus the restricted modifier) whenever you make a purchase.

Credentials. This is a corporate connection. You maintain a set of mid-level credentials to one of the major conglomerate corporations of the galaxy. This access provides you with internal information, access to “colleagues” and potentially access to corporate resources. Of course, if you are not actively working for the corporation and the corporation’s interests you need to be careful as to how you leverage these credentials lest they be revoked.

Level 1. Your Mid-level regional connections provide advantage on corporate investigation checks and access to corporate restricted information. If you check in regularly you can probably gain +1 Credit per month from your salary.

Level 2. Mid-level management connections allow you to gain access to restricted information and corporate restricted goods. Attend a few meetings and you can gain +2 Credit per month from your salary.

Level 3. At some point you became a VP of some minor department. You have free access to restricted information and can acquire restricted corporate goods at no additional cost. While your salary is +3 Credit per month, you are expected to maintain your division’s profitability, whatever that takes.

Secret Society. This is an underworld connection. You are an active member of a secretive cabal whose goals and ambitions may reach across the galaxy. You are aware of this secretive organization’s keywords, passphrases, and signs. Depending on the level of this connection, fellow members will turn a blind eye to your activities or offer you aid. This may manifest as discounts, or preferential treatment, or even a way to circumvent the law. However, you are expected to show the same loyalty to fellow members of this secret society.

Level 1. As an initiate of the organization you are privy to the foundational secrets of the group. You’ll know which corporations, vendors, or groups may be sympathetic as well as recognize other members when they signal their membership. A DC 15 Intelligence (investigation) check allows you to find sympathetic vendors or members, who will offer you a 1 Credit discount.

Level 2. You are a ranked member of the organization, aware of some small portion of the plans and goals, and deeper secrets of the group.

Your DC 15 Intelligence (investigation) check will allow you to find a level 1 fence, broker, or smuggler with connections to the society.

Level 3. The organization holds you in high regards and as a key piece to their larger goals. In addition to the benefits above, the organization provides you with a +2 Credit stipend. However, at this rank you will be give assignments at random to promote the Organization’s larger goals, which you may still be unaware of.

Actions Speak

Your Contacts and Connections are valuable resources that you need to look after. Not just because they can do thing for you, but because they represent your Reputation and social influence. If it gets around that you regularly double cross smugglers, you’ll very quickly find that no one will do business with you. Equally, if you ignore the expectations of your connections you might find that you quickly loose influence in the sphere.

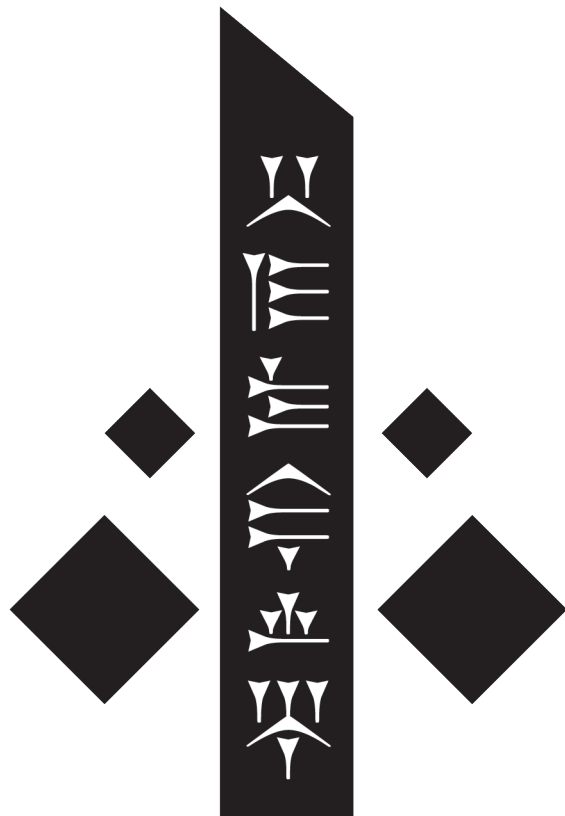

SECTION 08 COMBAT AND ACTION

Combat is an essential part of any action story, conflict is at the heart of drama, and though not all conflict is violent, all violence is conflict. Adventurers will often face adversaries that they must defeat to complete their missions and defend themselves from those who would stop them

THE ORDER OF COMBAT

A typical combat encounter is a clash between two sides, a flurry of weapon swings, feints, parries, footwork, and spellcasting. The game organizes the chaos of combat into a cycle of rounds and turns. A round represents about 6 seconds in the game world. During a round, each participant in a battle takes a turn.

The order of turns is determined at the beginning of a combat encounter, when everyone rolls initiative. Once everyone has taken a turn, the fight continues to the next round if neither side has defeated the other, or they choose to stop fighting.

Not All Conflict is Combat

While action and conflict make up the heart of any good adventure, don't feel like the rules here have to be exclusively used for combat. The ideas of initiative to determine action order, the timed rounds, and the compared action roll versus difficulty class can be used equally well for a chess match between two masters or a battle in cyberspace between elite hackers.

Combat Step by Step

1. Determine surprise. The GM determines whether anyone involved in the combat encounter is surprised.
2. Establish positions. The GM decides where all the characters and monsters are located. Given the adventurers' marching order or their stated positions in the room or other location, the GM figures out where the adversaries are how far away and in what direction.
3. Roll initiative. Everyone involved in the combat encounter rolls initiative, determining the order of combatants' turns.
4. Take turns. Each participant in the battle takes a turn in initiative order.
5. Begin the next round. When everyone involved in the combat has had a turn, the round ends. Repeat step 4 until the fighting stops.

Initiative

Initiative determines the order of turns during combat. When combat starts, every participant makes a Dexterity check to determine their place in the initiative order. The GM makes one roll for an entire group of identical creatures, so each member of the group acts at the same time.

Combatants act in order from the one with the highest Dexterity check total to the one with the lowest. This initiative order remains in place for each round. If a tie occurs, the GM decides the order among tied GM-controlled creatures, and the players decide the order among their tied characters. The GM can decide the order if the tie is between a monster and a player character. Optionally, the GM can have the tied characters and monsters each roll a d20 to determine the order, highest roll going first.

COMBAT & ACTION

Surprise

When one group gets the jump on another, they gain the element of surprise. In these situations, one side of the battle gains surprise over the other.

The GM determines who might be surprised. If neither side tries to be stealthy, they automatically notice each other. Otherwise, the GM compares the Prowl skill checks of anyone hiding with the passive Perception skill of each creature on the opposing side. Any character or monster that doesn't notice a threat is surprised at the start of the encounter. If you're surprised, you can't move or take an action on your first turn of the combat, and you can't take a reaction until that turn ends. A member of a group can be surprised even if the other members aren't.

Your Turn

On your turn, you can move a distance up to your speed and take one action. You decide whether to move first or take your action first. Your speed—sometimes called your walking speed—is noted on your character sheet.

The most common actions you can take are described in the “Actions in Combat” section. Many class features and other abilities provide additional options for your action.

The “Movement and Position” section gives the rules for your move. You can forgo moving, taking an action, or doing anything at all on your

turn. If you can't decide what to do on your turn, consider taking the Dodge or Ready action, as described in “Actions in Combat.”

Bonus Actions

Various class features, spells, and other abilities let you take an additional action on your turn called a bonus action. The Cunning Action feature, for example, allows a rogue to take a bonus action. You can take a bonus action only when a special ability, spell, or other feature of the game states that you can do something as a bonus action. You otherwise don't have a bonus action to take.

You can take only one bonus action on your turn, so you must choose which bonus action to use when you have more than one available. You choose when to take a bonus action during your turn, unless the bonus action's timing is specified, and anything that deprives you of your ability to take actions also prevents you from taking a bonus action.

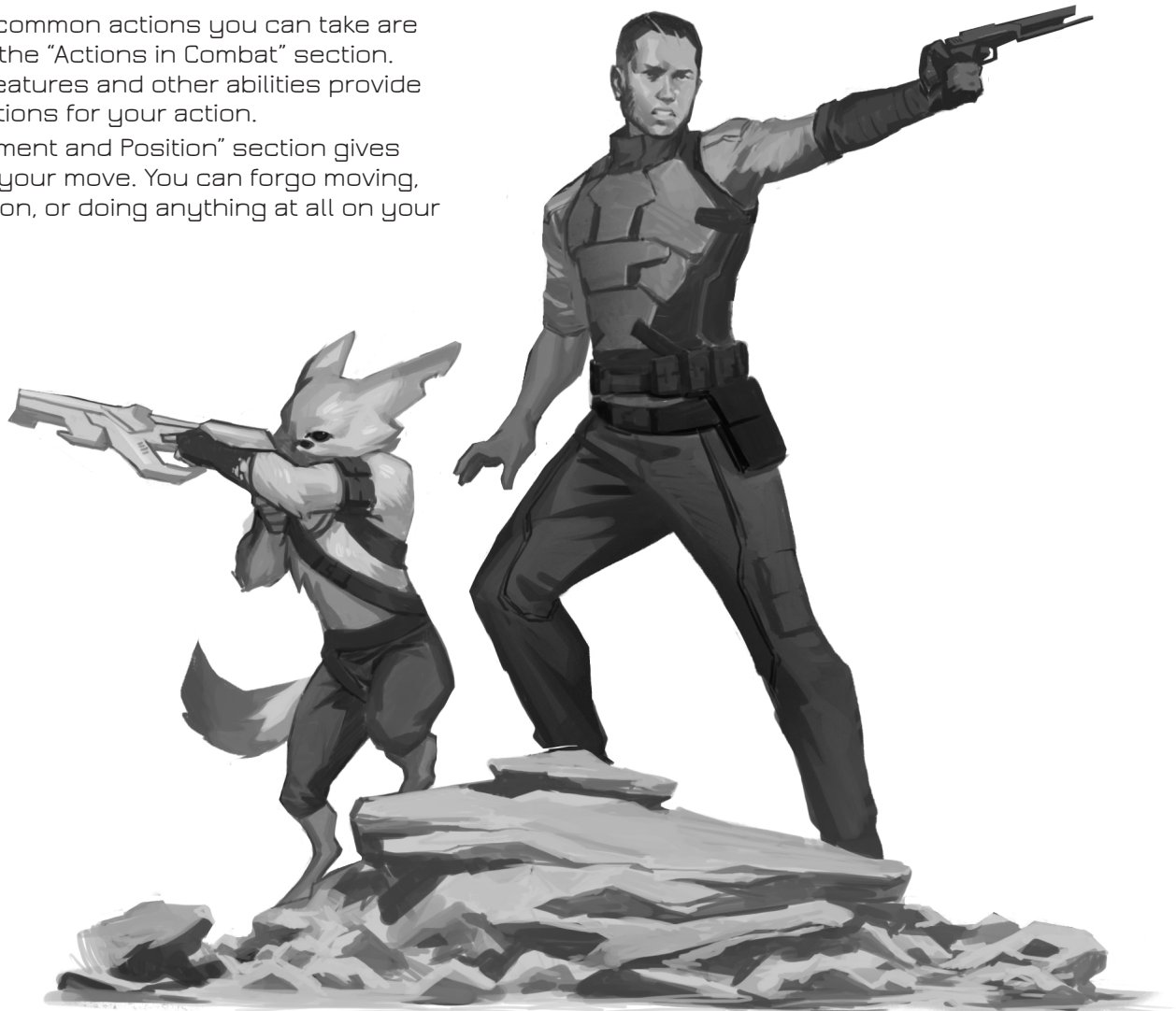

Other Activity on Your Turn

Your turn can include a variety of flourishes that require neither your action nor your move. You can communicate however you are able, through brief utterances and gestures, as you take your turn.

You can also interact with one object or feature of the environment for free, during either your move or your action. For example, you could open a door during your move as you stride toward a foe, or you could draw your weapon as part of the same action you use to attack.

If you want to interact with a second object, you need to use your action. Some magic items and other special objects always require an action to use, as stated in their descriptions. The GM might require you to use an action for any of these activities when it needs special care or when it presents an unusual obstacle. For instance, the GM could reasonably expect you to use an action to open a stuck door or turn a crank to lower a drawbridge.

Reactions

Certain special abilities, skills, and situations allow you to take a special action called a reaction. A reaction is an instant response to a trigger of some kind, which can occur on your turn or on someone else's. When you take a reaction, you can't take another one until the start of your next turn. If the reaction interrupts another creature's turn, that creature can continue its turn right after the reaction.

Movement and Position

In combat, characters and monsters are in constant motion, often using movement and position to gain the upper hand. On your turn, you can move a distance up to your speed. You can use as much or as little of your speed as you like on your turn, following the rules here.

Your movement can include jumping, climbing, and swimming. These different modes of movement can be combined with walking, or they can constitute your entire move. Regardless of how you're moving, you deduct the distance of each part of your move from your speed until it is used up or until you are done moving.

Breaking Up Your Move

You can break up your movement on your turn, using some of your speed before and after your action. For example, if you have a speed of 10 meters, you can move 3 meters, take your action, and then move 7 more meters.

Moving between Attacks

If you take an action that includes more than one weapon attack, you can break up your

movement even further by moving between those attacks. For example, a fighter who can make two attacks with the Extra Attack feature and who has a speed of 7 meters could move 5 meters, make an attack, move 2 more meters out of melee range, and then attack again.

Using Different Speeds

If you have more than one speed, such as your walking speed and a flying speed, you can switch back and forth between your speeds during your move. Whenever you switch, subtract the distance you've already moved from the new speed. The result determines how much farther you can move. If the result is 0 or less, you can't use the new speed during the current move.

For example, if you have a speed of 10 and a flying speed of 20 because you are equipped with a jump pack, you could fly 10 meters, then walk 5 meters, and then leap into the air to fly 5 meters more.

Difficult Terrain

Combat rarely takes place in bare rooms or on featureless plains. Boulder-strewn caverns, briar-choked forests, treacherous staircases—the setting of a typical fight contains difficult terrain.

Every foot of movement in difficult terrain costs 1 extra meters. This rule is true even if multiple things in a space count as difficult terrain. Low furniture, rubble, undergrowth, steep stairs, snow, and shallow bogs are examples of difficult terrain. The space of another creature, whether hostile or not, also counts as difficult terrain.

Being Prone

Combatants often find themselves lying on the ground, either because they are knocked down or because they throw themselves down. In the game, they are prone, a condition described in Appendix A. You can drop prone without using any of your speed. Standing up takes more effort; doing so costs an amount of movement equal to half your speed.

For example, if your speed is 10 meters, you must spend 5 meters of movement to stand up. You can't stand up if you don't have enough movement left or if your speed is 0. To move while prone, you must crawl. Every meter of movement while crawling costs 1 extra meter.

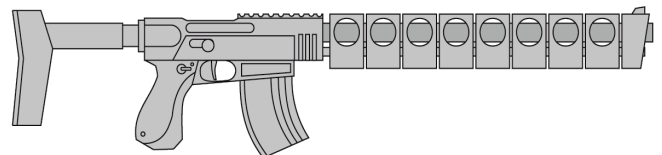

Interacting with Objects Around You

Here are a few examples of the sorts of thing you can do in tandem with your movement and action:

- draw or holster a weapon
- change a clip in a weapon
- open or close a door
- pull a flair from your pack
- enter a brief command in a console
- remove a ring from your finger
- start recording on your mobile device
- throw a lever or a switch
- turn on your flashlight
- take a book from a shelf you can reach
- extinguish a small flame
- don a gasmask
- hand an item to another character

Moving Around Other Creatures

You can move through a nonhostile creature's space. In contrast, you can move through a hostile creature's space only if the creature is at least two sizes larger or smaller than you. Remember that another creature's space is difficult terrain for you. Whether a creature is a friend or an enemy, you can't willingly end your move in its space.

If you leave a hostile creature's reach during your move, you provoke an opportunity attack.

Flying Movement

While flight provides an advantage in mobility and range, it carries significant risk of falling or being knocked to the ground. Should a flying creature be knocked prone, stunned, paralyzed, or grappled, the creature falls, unless it has the ability to hover or is operating in micro gravity.

Size

Creatures, mechs, and objects takes up a different amount of space. The Size Categories table shows how much space an obstacle or creature of each size controls in combat.

Objects sometimes use the same size categories.

Size Categories

Size	Space
Tiny	1 m by 1 m
Small	2 m by 2 m
Medium	2 m by 2 m
Large	3 m by 3 m
Huge	5 m by 5 m
Gargantuan or larger	7 m by 7 m

Space

A creature's space is the area in meters that it effectively controls in combat, not an expression of its physical dimensions. A typical Medium creature isn't 2 meters wide, for example, but it does control a space that wide. If a Medium Ba'alur stands in a 2-meter airlock, other creatures can't get through easily.

A creature's space also reflects the area it needs to fight effectively. For that reason, there's a limit to the number of creatures that can surround another creature in combat. Assuming Medium combatants, eight creatures can attack in a 2-meter radius.

Because larger creatures take up more space, fewer of them can surround a creature. Should five Large creatures crowd around a Medium or smaller target, there's little room for others. As many as twenty Medium creatures can surround a Gargantuan target, potentially all attacking without penalty.

Squeezing into a Smaller Space

A creature can squeeze through a space that is large enough for a creature one size smaller than it. Thus, a Large creature can squeeze through a medium passage. Being forced through such a cramped space costs twice as much movement each round and causes disadvantage on attack rolls and Dexterity saving throws. Attack rolls against the creature have advantage while it's in the cramped space.

ACTIONS IN COMBAT

When you take your action on your turn, you can take one of the actions presented here, an action you gained from your class or a special feature, or an action that you improvise. Many monsters have action options of their own in their stat blocks.

When you describe an action not detailed elsewhere in the rules, the GM tells you whether that action is possible and what kind of roll you need to make, if any, to determine success or failure.

Attack

The most common action to take in combat is the Attack action, whether you are firing a pistol, throwing a grenade, or just punching your way through.

With this action, you make one melee or ranged attack. See the "Making an Attack" section for the rules that govern attacks.

Certain features, such as the Extra Attack feature, allow you to make more than one attack with this action.

Dash

When you take the Dash action, you gain extra movement for the current turn. The increase equals your speed, after applying any modifiers. With a speed of 10 meters, for example, you can move up to 20 meters on your turn if you dash.

Any increase or decrease to your speed changes this additional movement by the same amount. If your speed of 10 meters is reduced to 5 meters, for instance, you can move up to 10 meters this turn if you dash.

Disengage

If you take the Disengage action, your movement doesn't provoke opportunity attacks for the rest of the turn.

Dodge

When you take the Dodge action, you focus entirely on avoiding attacks. Until the start of your next turn, any attack roll made against you has Disadvantage if you can see the attacker, and you make Dexterity saving throws with advantage. You lose this benefit if you are incapacitated (as explained in Appendix A) or if your speed drops to 0.

Aid

You can lend your help to another creature in the completion of a task. When you take the Aid action, the creature you aid gains advantage on the next skill check it makes to perform the task you are aiding with, provided that it makes the check before the start of your next turn.

Alternatively, you can aid a friendly creature in attacking a creature within 2 meters of you. You feint, distract the target, or in some other way team up to make your ally's attack more effective. If your ally attacks the target before your next turn, the first attack roll is made with advantage.

Hide

When you take the Hide action, you make a Dexterity (Stealth) check in an attempt to hide, following the rules for hiding. If you succeed, you gain certain benefits, as described in the "Unseen Attackers and Targets" section.

Ready

Sometimes you want to get the jump on a foe or wait for a particular circumstance before you act. To do so, you can take the Ready action on your turn, which lets you act using your reaction

before the start of your next turn.

First, you decide what perceivable circumstance will trigger your reaction. Then, you choose the action you will take in response to that trigger, or you choose to move up to your speed in response to it. Examples include "If the cultist steps on the trapdoor, I'll pull the lever that opens it," and "If the goblin steps next to me, I move away."

When the trigger occurs, you can either take your reaction right after the trigger finishes or ignore the trigger. Remember that you can take only one reaction per round.

Skill

When you take the Skill action, you devote your attention to using one of your skills.

Use an Object

You normally interact with an object while doing something else, such as when you draw a sword as part of an attack. When an object requires your action for its use, you take the Use an Object action. This action is also useful when you want to interact with more than one object on your turn.

Making an Attack

Regardless of how, or with what weapons, an attack has a simple structure.

1. Choose a target. Pick a target within your attack's range: a creature, an object, or a location.

2. Determine modifiers. The GM determines whether the target has cover and whether you have advantage or disadvantage against the target. Special abilities, advanced weapons, conditions and other effects can apply penalties or bonuses to your attack roll.

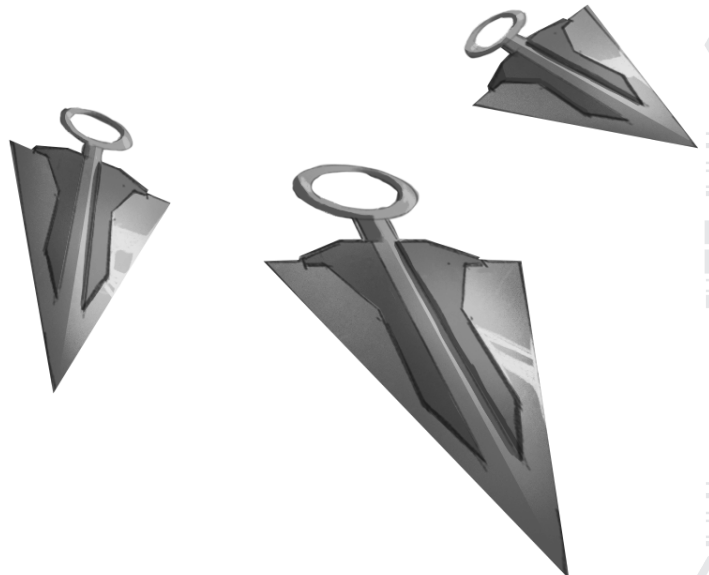

3. Resolve the Attack. If your hit is confirmed, and greater than their Armor Rank (if any) you roll damage, unless the particular attack has rules that specify otherwise. A hit that is less than the target's Armor Ranks might have reduced damage. Some attacks cause special effects in addition to or instead of damage.

Any action that requires an attack roll qualifies as an attack.

Attack Rolls

When you make an attack, your attack roll determines whether the attack hits or misses. To make an attack roll, roll a d20 and add the appropriate modifiers. If the total of the roll plus modifiers equals or exceeds the target's Armor Class (AC), the attack hits. The AC of a character is determined at character creation, whereas the AC of a monster is in its stat block.

Modifiers to the Roll

When a character makes an attack roll, the two most common modifiers to the roll are an ability modifier and the character's proficiency bonus. When a monster makes an attack roll, it uses whatever modifier is provided in its stat block.

Ability Modifier. The ability modifier used for a melee weapon attack is Strength, and the ability modifier used for a ranged weapon attack is Dexterity. Weapons that have the finesse, targeted or thrown property break this rule.

Proficiency Bonus. You add your proficiency bonus to your attack roll when you attack using a weapon with which you have proficiency, as well as when you attack with a spell.

Rolling 1 or 20

Sometimes fate blesses or curses a combatant, causing the novice to hit and the veteran to miss. If the d20 roll for an attack is a 20, the attack hits regardless of any modifiers or the target's AC. This is called a critical hit.

If the d20 roll for an attack is a 1, the attack misses regardless of any modifiers or the target's AC.

Armor Class and Armor Rank

When an attack is made, you must meet or exceed the target's Armor Class to score a hit. Attacks against a creature proficient in and wearing armor have to beat that extra layer of defense. Armor Rank is generally equal to the target's AC plus their proficiency bonus. If an attack roll is greater than AC, but less than the AR, then the damage is reduced by the armor's Armor Rank Modifier.



Defensive Reaction

The normal defensive ebb and flow of combat is accounted for in the normal Armor Class of combatants. That does not mean that if you are attacked you are powerless to defend yourself. Some skills, such as deflect, and some class features or feats allow you to use your reaction defensively.

Unseen Attackers and Targets

Combatants often try to escape their foes' notice by hiding, the use of optical camouflage, or creating distractions. If you attempt to attack an unseen, or hidden target you have disadvantage on the attack roll. This is true whether you're guessing the target's location or you're targeting a creature you can hear but not see. If the target isn't in the location you targeted, you automatically miss, but the GM typically just says that the attack missed, not whether you guessed the target's location correctly.

When you are hidden or unseen, you have advantage on attack rolls against creatures that are unable to sense you. If you are hidden—both unseen and unheard—when you make an attack, you give away your location when the attack hits or misses.

Ranged Combat

When you make a ranged attack, such as firing a pistol, throwing a grenade, or launching a missile you are attacking a target at distance. This changes the timing and reactions of combat.

Range

You can make ranged attacks only against targets within a specified range. Most ranged attacks, such as those made with a rifle or an energy weapon, have two ranges. The smaller number is the normal range, and the larger number is the long range. Your attack roll has disadvantage when your target is beyond normal range, and you can't attack a target beyond the long range.

Ranged Attacks in Close Combat

Aiming a ranged attack is more difficult when a foe is next to you. When you make a ranged attack, you have Disadvantage on the attack roll if you are within 2 meters of a hostile creature who can see you and who isn't incapacitated, other than you target.

Moreover, if you are firing from range into a melee where two or more creatures are fighting, you suffer Disadvantage if you are trying not to hit creatures other than your target. If you miss, regardless, compare that to the AC of any creatures within 2 meters of your target, if you would hit any of them, you do. If you would hit multiple creatures, you hit the one with the lowest AC, if it is a tie, you strike the one with the lowest dexterity score, if that is a tie you hit the one with the lowest initiative score.

Contact Shot. Modern weapons are extremely dangerous and lethal. If you are able to move up to and place a modern ranged weapon such as a firearm or energy weapon against your target before you fire, you may perform a contact shot. To perform this maneuver, you must be within melee range, and succeed a touch attack roll to position your weapon as your standard action. Following this you may use your bonus action to make one attack roll with Advantage. If you hit, you add one extra dice of damage. If you successfully grapple your target, you may use your bonus action to make a contact shot against the target that you have grappled if you are using a one-handed small firearm.

Melee Combat

Used in hand-to-hand combat, a melee attack allows you to attack a foe within your reach. A melee attack typically uses a handheld weapon such as a stun baton, knife, or even a sword. A hostile alien might make a melee attack when it strikes with its tentacles, claws, horns, teeth, or other body part.

Most creatures have a 2 meter reach and can thus attack targets within 2 meters of them when making a melee attack. Certain creatures (typically those larger than Medium) have melee attacks with a greater reach than this, as noted in their descriptions.

Instead of using a weapon to make a melee weapon attack, you can use an unarmed strike: a punch, kick, head-butt, or similar forceful blow (none of which count as weapons). On a hit, an unarmed strike deals bludgeoning damage equal to 1 + your Strength modifier. Unless you have a martial arts skill, you are not proficient with your unarmed strikes.

Opportunity Attacks

In a fight, everyone is constantly watching for a chance to strike an enemy who is fleeing or passing by. Such a strike is called an opportunity attack. You can make an opportunity attack when a hostile creature that you can see moves out of your reach. To make the opportunity attack, you use your reaction to make one melee attack against the provoking creature. The attack occurs right before the creature leaves your reach.

You can avoid provoking an opportunity attack by taking the Disengage action. You also don't provoke an opportunity attack when you teleport or when someone or something moves you without using your movement, action, or reaction. For example, you don't provoke an opportunity attack if an explosion hurls you out of a foe's reach or if gravity causes you to fall past an enemy.

Two-Weapon Fighting

When you take the Attack action and attack with a light melee weapon or a small handgun that you're holding in one hand, you can use a bonus action to attack with the weapon that you're holding in the other hand. You don't add your ability modifier to the attack or damage of the bonus attack; unless that modifier is negative.

If either weapon has the thrown property, you can throw the weapon, instead of making a melee attack with it.

Grappling

When you want to grab a creature or wrestle with it, you can use the Attack action to make a special melee attack, a grapple. If you're able to make multiple attacks with the Attack action, this attack replaces one of them.

The target of your grapple must be no more than one size larger than you and must be within your reach. Using at least one free hand, you try to seize the target by making an Unarmed Attack grapple check. The target may make an Unarmed attack, Deflect, or Armor Proficiency check to break your grapple attempt. If you succeed, you subject the target to the grappled condition (see Appendix A). The condition specifies the things that end it, and you can release the target whenever you like (no action required).

Escaping a Grapple. A grappled creature can use its action to escape. To do so, it must succeed on a Strength check or Unarmed Attack check contested by your skill or ability check.

Moving a Grappled Creature. When you move, you can drag or carry the grappled creature with you, but your speed is halved, unless the creature is two or more sizes smaller than you.

Shoving a Creature

Using the Attack action, you can make a special melee attack to shove a creature, either to knock prone or push it away from you. If you're able to make multiple attacks with the Attack action, this attack replaces one of them. The target must be no more than one size larger than you and must be within your reach. Instead of making a normal attack roll, you make an Unarmed attack check contested by the target's Strength check or Unarmed attack check. If you win the contest, you either knock the target prone or push it 2 meters away from you.

Cover

Walls, asteroids, wreckage, and chaff can provide cover during combat, making a target more difficult to harm. A target can benefit from cover only when an attack or other effect originates on the opposite side of the cover.

There are three degrees of cover. If a target is behind multiple sources of cover, only the most protective degree of cover applies; the degrees aren't added together. For example, if a target is behind a creature that gives half cover and a tree trunk that gives three-quarters cover, the target has three-quarters cover.

A target with half cover has a +2 bonus to AC and Dexterity saving throws. A target has half cover if an obstacle blocks at least half of its body. The obstacle might be a low wall, a sturdy table or vending machine, thick vegetation, or a creature, whether that creature is an enemy or a friend.

A target with three-quarters cover has a +5 bonus to AC and Dexterity saving throws. A target has three-quarters cover if about three-quarters of it is covered by an obstacle. The obstacle might be a barricade, a narrow window, or a vehicle.

A target with total cover can't be targeted directly by a ranged attack but you can reach such a target by including it in an area of effect. A target has total cover if it is completely concealed by an obstacle.

DAMAGE AND HEALING

Injury and the risk of death are constant companions of those who explore fantasy gaming worlds. The thrust of a sword, a well-placed arrow, or a blast of flame from a fireball spell all have the potential to damage, or even kill, the hardiest of creatures.

Hit Points

Hit points represent a combination of physical and mental durability, the will to live, and luck. Creatures with more hit points are more difficult to kill. Those with fewer hit points are more fragile.

A creature's current hit points (usually just called hit points) can be any number from the creature's hit point maximum down to 0. This number changes frequently as a creature takes damage or receives healing. Whenever a creature takes damage, that damage is subtracted from its hit points. The loss of hit points has no effect on a creature's capabilities until the creature drops to 0 hit points.

Damage Rolls

Each weapon, spell, and harmful monster ability specifies the damage it deals. You roll the damage die or dice, add any modifiers, and apply the damage to your target. Magic weapons, special abilities, and other factors can grant a bonus to damage. With a penalty, it is possible to deal 0 damage, but never negative damage. When attacking with a weapon, you add your ability modifier to both the attack and the damage roll, be that strength dexterity, or a different ability score.

Critical Hits

When you score a critical hit, you get to roll extra dice for the attack's damage against the target. Roll all of the attack's damage dice twice and add them together. Then add any relevant modifiers as normal. To speed up play, you can roll all the damage dice at once.

For example, if you score a critical hit with a dagger, roll 2d4 for the damage, rather than 1d4, and then add your relevant ability modifier. If the attack involves other damage dice, such as from the rogue's Sneak Attack feature, you roll those dice twice as well.

Damage Types

Different attacks, damaging spells, and other harmful effects deal different types of damage. Damage types have no rules of their own, but other rules, such as damage resistance, rely on the types.

The damage types follow, with examples to help a GM assign a damage type to a new effect.

Bludgeoning. Low impact attacks such as hammers, fists, and falling, deal bludgeoning damage.

Corrosive. Extremely powerful acids and bases that can eat away at material cause corrosive damage. Generally, these attacks will only damage some materials while ignoring others.

Cryonic. This kind of instantly freezing chill that comes from being attacked with liquid xenon, super-cooled explosives, or strange artifacts.

Electromagnetic. Ion beam weapons, lightning bolts, and pulse weapons deal EM damage.

Force. Concussion weapons, gravity-based artifacts, and some rare abilities deal this kind of pure kinetic damage.

Impact. High velocity weapons such as most firearms and mass-drivers, as well as celestial events like meteors cause impact damage.

Piercing. Puncturing and impaling attacks, including spears and arrows, deal piercing damage.

Poison. A venomous bite or cloud of noxious gas would deal poison damage.

Psychic. Extremely rare attacks may do damage on an intrinsic level to intelligent creatures.

Radiation. Directed ionizing beams, cosmic rays, and unstable weapons cause radiation damage. While powerful radiation can cause thermal or corrosive effects, direct radiation damage comes from breaking down electron bonds.

Slashing. Knives, swords, and claws all cause slashing damage.

Sonic. A concussive burst or the shockwave from explosives can cause Sonic damage. This kind of damage requires a medium, such as an atmosphere, to propagate. As such in a vacuum, it is useless.

Thermal. Lasers, fire, plasma, incendiary weapons, and explosives can deal thermal damage.

Damage Resistance and Vulnerability

Some creatures and objects are exceedingly difficult or unusually easy to hurt with certain types of damage. If a creature or an object has Resistance to a damage type, damage of that type is halved against it. If a creature or an object has vulnerability to a damage type, damage of that type is doubled against it.

Resistance and then vulnerability are applied after all other modifiers to damage. For example, a creature has resistance to bludgeoning damage and is hit by an attack that deals 25 bludgeoning damage. The creature is also within a magical aura that reduces all damage by 5. The 25 damage is first reduced by 5 and then halved, so the creature takes 10 points of damage.

Multiple instances of resistance or vulnerability that affect the same damage type count as only one effect. For example, if a creature has resistance to fire damage as well as resistance to all nonmagical damage, the damage of a nonmagical fire is reduced by half against the creature, not reduced by three-quarters.

If a creature has immunity, then damage from that source is ignored completely.

Healing

Unless it results in death, damage isn't permanent. Even death is reversible through powerful magic. Rest can restore a creature's hit points, and advanced medical technology such as medi-packs can restore hit points very quickly.

When a creature receives healing of any kind, hit points regained are added to its current hit points. A creature's hit points can't exceed its hit point maximum, so any hit points regained in excess of this number are lost.

A creature that is dead could be regenerated via technology while remaining in stasis or healed just enough to restore consciousness and motor function.

Characters and Death

When you drop to 0 hit points, you either die outright or fall unconscious, as explained in the following sections.

Instant Death

Massive damage can kill you instantly. When damage reduces you to 0 hit points and there is damage remaining, you die if the remaining damage equals or exceeds your hit point maximum.

For example, a spacer with a maximum of 12 hit points currently has 6 hit points. If she takes 18 damage from an attack, she is reduced to 0 hit points, but 12 damage remains. Because the remaining damage equals her hit point maximum, the Spacer dies.

Falling Unconscious

If damage reduces you to 0 hit points and fails to kill you through massive damage, you fall unconscious (see Appendix A). You recover if your hit points are raised above 0.



Death Saving Throws

Whenever you start your turn with 0 hit points, you must make a special saving throw, called a death saving throw, to determine whether you creep closer to death or hang onto life. Unlike other saving throws, this one isn't tied to any ability score. You are in the hands of fate now, aided only by feats and features that improve your chances of succeeding on the saving throw.

Roll a d20. If the roll is 10 or higher, you succeed. Otherwise, you fail. A success or failure has no effect by itself. On your third success, you become stable (see below). On your third failure, you die. The successes and failures don't need to be consecutive; keep track of both until you collect three of a kind. The number of both is reset to zero when you regain any hit points or become stable.

Rolling 1 or 20. When you make a death saving throw and roll a 1 on the d20, it counts as two failures. If you roll a 20 on the d20, you regain 1 hit point and regain consciousness.

Damage at 0 Hit Points. If you take any damage while you have 0 hit points, you suffer a death saving throw failure. If the damage is from a critical hit, you suffer two failures instead. If the damage equals or exceeds your hit point maximum, you suffer instant death.

Stabilizing a Creature

You can use your action to administer aid to an unconscious creature and attempt to stabilize it with a Wisdom (medicine) proficiency, which requires a successful DC 10 check.

A stable creature doesn't make death saving throws, even though it has 0 hit points, but it does remain unconscious. The creature stops being stable, and must start making death saving throws again, if it takes any damage. A stable creature that isn't healed regains 1 hit point after 1d4 hours.

Unless specified otherwise, it is not possible to stabilize a dying creature in microgravity.

Adversaries and Death

Most GMs have an enemy creature die the instant it drops to 0 hit points, rather than having it fall unconscious and make death saving throws. Mighty villains and special nonplayer characters are common exceptions; the GM might have them fall unconscious and follow the same rules as player characters.

Knocking a Creature Out

Sometimes an attacker wants to incapacitate a foe, rather than deal a killing blow. When an attacker reduces a creature to 0 hit points with a melee attack, the attacker can knock the creature out. The attacker can make this choice the instant the damage is dealt. The creature falls unconscious and is stable.

Temporary Hit Points

Some feats or features confer temporary hit points to a creature. Temporary hit points aren't actual hit points; they are a buffer against damage, a pool of hit points that protect you from injury.

When you have temporary hit points and take damage, the temporary hit points are lost first, and any leftover damage carries over to your normal hit points. For example, if you have 5 temporary hit points and take 7 damage, you lose the temporary hit points and then take 2 damage.

Because temporary hit points are separate from your actual hit points, they can exceed your hit point maximum. A character can, therefore, be at full hit points and receive temporary hit points.

Healing can't restore temporary hit points, and they can't be added together. If you have temporary hit points and receive more of them, you decide whether to keep the ones you have or to gain the new ones. For example, if a drug grants you 12 temporary hit points when you already have 10, you can have 12 or 10, not 22.

If you have 0 hit points, receiving temporary

hit points doesn't restore you to consciousness or stabilize you. They can still absorb damage directed at you while you're in that state, but only true healing can save you. Unless a feature that grants temporary hit points has a duration, these last until they're depleted or you finish a long rest.

VEHICLE COMBAT

Two fighter mechs dance through the debris of a devastating battle, a game of deadly cat and mouse, each angling to get a clean shot on the other. From the back of a speeding motorcycle a passenger unleashes reckless automatic fire at their pursuers. Alarms blare as the gunnery officer aboard a massive dreadnaught unleashes another volley at their opponent, matching them hit for hit as the two massive ships circle one another.

Advent Horizon takes place in a distant future filled with space ships, power armor, jets, and tanks. It should be no surprise that, especially at higher levels, much of the combat will take place in, around, or between vehicles.

Vehicular combat, be it fighting from the back of a buggy on an alien world or a dogfight in the depths of space, follows the same rules or order and standard combat with initiative, rounds, turns and potentially surprise. The most significant difference is that in vehicular combat, vehicles are probably not sitting still, so rather than position you will determine vectors, the direction and speed of each vehicle.

Targeting

Most Ship to Ship combat takes place with semi-targeted weapons. Weapons with their own targeting computers can attack autonomously when directed to using the computer's attack bonus. If you choose to target manually with ship's weapons, you need the Weapons Systems proficiency to add proficiency bonus to your attack rolls.

When you make an attack against a vehicle or structure such as a space station, you can choose to attempt to target a specific component or area, such as the engines, weapons, targeting, or crew. In such a case your attack roll is made with disadvantage. If you score a hit, all of the damage is directed towards that one component or area of the ship, which may cause some systems to fail if it is destroyed.

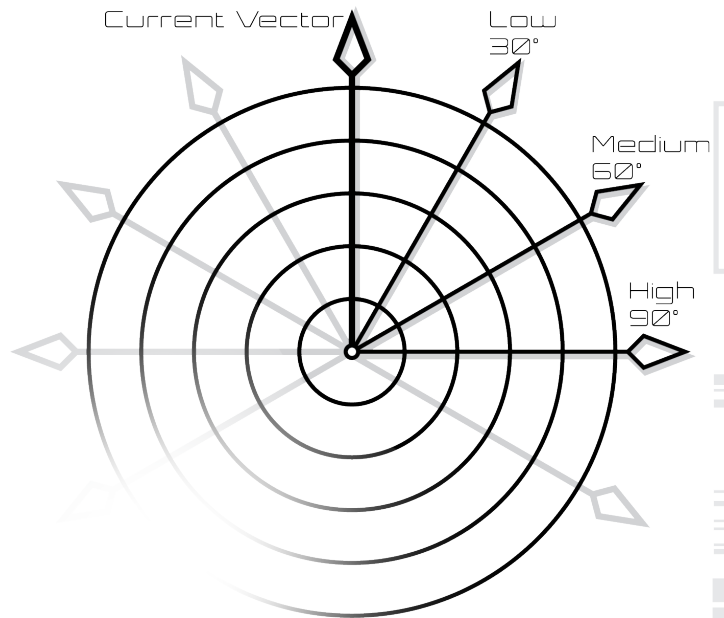

Vector and Movement

Vehicular combat is defined by motion. While in a moving vehicle, standard movement is replaced by a vector, a direction and amount of distance you will cover on your turn. You do not use your move action to travel along this vector if you are piloting or riding a vehicle. Rather, you use your move action to either dodge or to change your vector.

Changing Vector

How much you can change your vector depends on the maneuverability of your vehicle.

Low. You can change your vector by as much as 30 degrees without attempting a maneuver.

Medium. You can change your vector by as much as 60 degrees without attempting a maneuver.

High. You can change your vector by up to 90 degrees on your move without attempting a maneuver.

Vehicle Maneuvers

While you're in the driver's seat, you have several maneuvers you can take as your move action. Each requires a suitable driving or piloting skill check against the DC described. Regardless of how many attacks you may have from class or skill abilities, you may only take one action, one reaction, and one bonus action during vehicle combat. Assuming you are moving, move is counted towards the vector of your vehicle. If you are a passenger, you are free to move as you please within the confines of the vehicle or bail out.

General Vehicle Maneuvers

Cutoff. DC 10. You position yourself ahead of a target and slow to one half your present speed, forcing the target to slow or stop, change vectors or collide with you.

Dodge. DC 15. You take evasive maneuver such as swerving wildly, performing a barrel-roll, or pulling a risky deceleration. Either way, you remain on generally the same vector, but try to make your vehicle harder to hit.

Disengage. DC 10. You change your vector and accelerate to your maximum speed in hopes of throwing off pursuers and leaving combat. While you will not provoke attacks or opportunity, you may not lose your attacker if they are faster.

Ram. Special. This is an extremely dangerous maneuver. You change your vector to target an enemy to collide with them at full force. The piloting check is determined as an attack-roll. On a successful roll, the vehicles collide, taking full damage (see Collisions in Section 9).

Sideswipe. Special. Like a ram this is a dangerous maneuver, you make an attack roll with your piloting skill. If you succeed both ships take 1D10 collision damage, and the target is forced onto a new vector in the direction of the impact until the end of the target pilots next turn.

Surface Vehicle Maneuvers

Bootleg Turn. DC 15. This is a 180 degree turn in a surface vehicle. Successfully pulling this maneuver will point your vector in the opposite direction.

Drift. DC 10. Drifting allows you to change your vector by 90 degree without slowing or stopping and can make it hard to follow. A Drift Maneuver is not faster than a regular turn, but when performed successfully does allow for greater acceleration after the turn, to use such maneuvers as Dodge or Disengage.

E-Break. DC 10. This is a potentially risky move, but essentially you bring your vehicle to a complete halt. If you succeed, by the end of your turn your speed will be zero.



Aircraft Maneuvers

Immelmann Turn, DC 15. This maneuver can have multiple forms but the general result is the same, in as short a distance as possible the aircraft's vector is reversed and is flying in the opposite direction at the end of your turn. Most forms of Immelmann result at flying lower or higher altitude, though a the most complicated versions can leave you flying on the same altitude and even the back tracing your previous flight path, but this is much more difficult (DC 20).

Tailslide. DC 15. One of the riskiest air maneuvers this can potentially stall many aircraft. While there are many forms of this maneuver, in almost all cases the aircraft nose is pointed straight up, and the aircraft holds a position with a speed of 0 until the end of your turn. This can be used to Get behind an enemy craft or to dodge missiles incapable of turns.

Spacecraft Maneuvers

Tail Flip. DC 15. In space combat, the lack of an atmosphere to consider enables a maneuver where the main thrust is cut, and you flip the ship nose to tail, flying backwards at the end of your turn, but still moving at the original speed and along the same vector.

Vector Flip. DC 10. With this maneuver you point the nose in a direction other than your original vector, but do not Engauge thrust. On your next turn you can take the dodge action in the ship as your bonus action.

Zero Immelmann. DC 15. As the name implies this is functionally like an Immelmann, you flip the ship nose to tail and engage main thrust to return along your previous vector. However, at the end of your turn, you will be stopped until the beginning of your next round as inertial is canceled from this high G maneuver.



Mounting and Bailing

Once during your move, you can mount a Medium or Large vehicle or willing creature that is within 2 meters of you, or dismount. Doing so costs an amount of movement equal to half your speed. For example, if your speed is 10 meters, you must spend 5 meters of movement to mount a motorcycle. Therefore, you can't mount it if you don't have 5 meters of movement left or if your speed is 0.

Piloting a Huge or larger ship in standard melee leaves you open to attack, as most enemies will either be onboard with you or have line of sight to shoot you from a distance. In these kinds of vehicles, moving to the pilot or command seat, and seizing command of the vehicle are normal move and use item actions.

Bailing out of a moving vehicle can be extremely dangerous. leaping from a surface vehicle you must succeed a Dexterity saving throw DC 15 or take 1d6 bludgeoning damage per 20Km/h of speed, you will continue to roll and tumble for 5 meters after you have bailed. Bailing out of a speeding watercraft you must save or suffer 1d4 per 20km/h of speed.

Leaping from an aircraft or space craft carries no immediate danger. However, in the air you will begin plummeting to the surface, and in space you will continue along your vector unless you hit something or are rescued.

Damage and Repair

Most vehicles have a single pool of hit points just like characters. When a vehicle reaches 0 hit points it is disabled. When a vehicle is disabled the pilot can cannot change vector, KZM shields no longer function, and any sensor systems have disadvantage.



At the end of each round in which a vehicle begins with 0 hit points, and any time it takes damage in that round the vehicle slips one step closer to being destroyed - like a failed death saving throw for a creature. With each step an additional system fails aboard ships. After three rounds, unless damage control is initiated, the vehicle is destroyed, potentially killing all those onboard as well.

Random system failure

D8	Failed System
1	Life Support (1d4 hours of air)
2	Artificial Gravity
3	Main Computers
4	Communications
5	Sensor systems
6-7	Weapon systems
8	Reactor Containment (destroyed)

Damage Control

When a vehicle is disabled, its condition can be stabilized when at least one-tenth of the crew, minimum of one person, makes a successful Intelligence (engineering) check against a DC 15, or makes a Repair Kit (intelligence) check against a DC 15. This will prevent further deterioration of the ship's condition, but does not repair any hit points, or recover any failed systems. If the vehicle takes any damage after damage control is initiated, a system fails, and the deterioration begins again where it left off.

Destroyed

After three rounds accumulative rounds of deterioration, a disabled ship is destroyed - violently breaking apart and exploding as reactor containment fails and the ship's weapons and fuel ignite.

Crew aboard a ship when it is destroyed take damage as outlined below, and are jettisoned into space or plummet to the planet if they are in a low orbit or atmosphere.

Crew Damage

Size	Damage
Shuttles	4d10 thermal
Light	6d10 thermal
Medium	10d10 thermal
Heavy	20d10 thermal
Capitol	100d10 thermal

Riding Animals

While you are riding another creature, you have two options. You can either control the mount or allow it to act independently.

You can control a mount only if it has been trained to accept a rider. Domesticated horses, donkeys, and similar creatures are assumed to have such training. The initiative of a controlled mount changes to match yours when you mount it. It moves as you direct it, and it has only three action options: Dash, Disengage, and Dodge. A controlled mount can move and act even on the turn that you mount it.

An independent mount retains its place in the initiative order. Bearing a rider puts no restrictions on the actions the mount can take, and it moves and acts as it wishes. It might flee from combat, rush to attack and devour a badly injured foe, or otherwise act against your wishes.

In either case, if the mount provokes an opportunity attack while you're on it, the attacker can target you or the mount.

ENVIRONMENTAL VARIABLES

Micro Gravity Combat

Attacking with a melee weapon in micro gravity is nearly impossible without assistance of maneuvering jets, or a solid and significant mass to push off from. All melee attacks made without such assistance or training are made with disadvantage.

After making an attack with a firearm, heavy weapon, or railgun in micro gravity, if you are not braced against an object you move a number of meters back equal to the damage dice of the weapon. For example, a 3d6 shotgun will throw you back 3 meters, whereas a Railgun might send you flying 20 meters. If you travel more than 5 meters and hit something, you suffer collision damage.

Underwater Combat

When making a melee weapon attack, a creature that doesn't have a swimming speed (either natural or granted by magic) has disadvantage on the attack roll unless the weapon is a dagger, javelin, short sword, spear, or trident.

A ranged weapon attack automatically misses a target beyond the weapon's normal range. Even against a target within normal range, the attack roll has disadvantage unless the weapon is a crossbow, a net, or a weapon that is thrown like a javelin (including a spear, trident, or dart).

Creatures and objects that are fully immersed in water have resistance to fire damage.

Vacuum Combat

In a vacuum, such as outside a ship during EVA, a number of things change.

Fire. Fire is an exothermic reaction of oxidation, things cannot be lit on fire in a vacuum, and any ongoing fire damage ends.

Sonic. All kinds of sonic damage require a medium to propagate, which does not exist in a vacuum. All sonic damage is nullified in a vacuum.

Thermal. While fire cannot burn in space, objects cannot lose heat due to thermal conduction (cooled by radiating heat into a medium). Each consecutive thermal attack on a target in a vacuum increases the amount of damage they sustain and increases the minimum of the damage dice rolled for damage, starting a 1 on the first attack, and increasing by one point for each successful attack which causes thermal damage.

For example, if a satellite takes four laser blasts, then the minimum damage a dice can do is 4, or whatever the maximum value of each damage dice, whichever is lower.

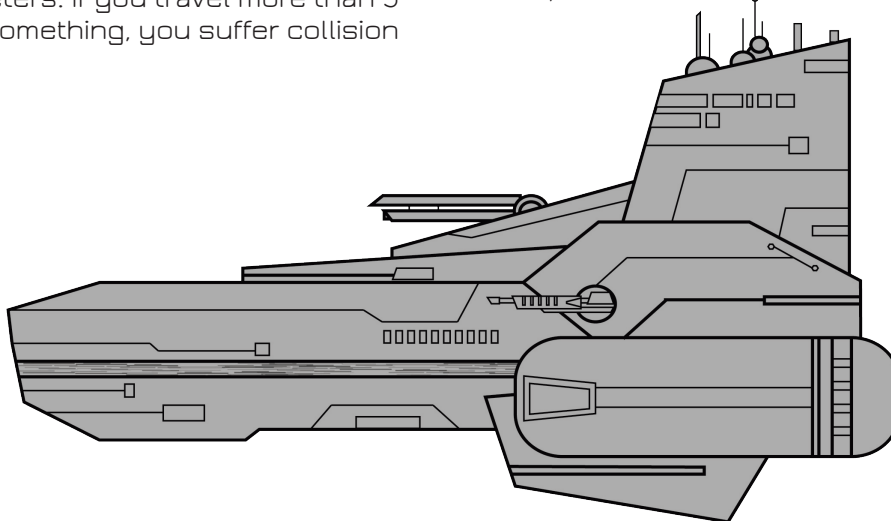

SECTION 09 EXPLORATION

Making planet fall on an ancient alien world, navigating the corridors of a deep space supply station, delving into the ruins of a civilization long dead. Advent Horizon is a game about exploration, and your adventures will be made up of moments like these. Your characters may be the first to discover a long-lost world, or uncover a devious corporate plot, you may find dangerous alien life, or brutal assassins. Surviving the dangers of the Arc means riches and reputation, and with each adventure it can only grow.

This section will address exploration and adventure, and the consequences of space travel such as time dilation and time debt. The rules for other aspects of adventuring life will be covered here as well, such as rest, research, and quality of life.

TIME

When the passage of each moment becomes a matter of life and death, the GM generally determines the time a task requires. Some activities have clear specific times requires, such as travel or crafting, others depend on the context of the situation. When adventurers are running through ruins being hunted by dangerous aliens, minutes and rounds, 6-seconds sections of time, are the time scale used.

As adventurers go about their day engaging in research, meeting contacts, or moving through town, time in hours is appropriate.

As players travel from one planet to another, time in the scale of days or even weeks might be best. Even with a Horizon Drive, traveling from the edge of the Magisterium to the frontier of the Arc can take several uneventful months unless regular stops are made along the way.

Time Dilation and Time Debt

Space is a vast and harsh mistress. Traveling the starways means encountering regions of space that are slowed compared to the rest of the universe. This is particularly true when one travels close to the speed of light, or travels into an immense gravity well. When this occurs, time dilates – time in reference to those outside the event is experienced at an accelerated rate.

A space ship might get caught in the well of a massive blackhole, for the crew of the ship mere days pass as they find a way to ride the gravitational eddies out of the black hole's well, but for the rest of the universe, months or years have passed. Throughout the galaxy this phenomenon is known as time debt. For most, this accounts to a few days or weeks over their lifetime, for adventurers, this could add up to years or centuries.

For the most part the galaxy's temporal constant is calculated by super computers and ancient machines which largely agree. The Imperium calls this the Aeonon Gnomon – The Dial of Ages. This led to the term Aeonon Time; it is from this point that Time Debt is calculated, and accepted times and dates are set throughout the Arc.

There is no mechanical effect to Time Debt less than hundreds or thousands of years, which rarely occurs. Yet it matters as many of the original colonists from earth incurred centuries of time debt before they were established. For some colonials, only a few decades have passed since they departed their old world – yet for the galaxy, more than a millennium of time has taken place.

Most regions of the galaxy that incur substantial time debt are well known and

charted, so travelling them is an understood risk. Players that accrue time debt may find that their relationships and reputation of changed considerably in their absence. There are legends of wanderers and mercenaries that have become the figure heads of cults through meaningless actions, only to return to their home later to discover the consequences of their actions.

MOVEMENT

Rocketing through the interplanetary void, marching across a barren world, and running through the corridors of an ancient ruin. Science fiction adventure means space travel, alien locations, and distant worlds. But the GM doesn't need to get caught up on the specifics of this unless it is a part of the story they are trying to tell.

In most cases the GM can summarize the adventurers' movement without the need to calculate distances, travel times, and time debt:

"After several days aboard the Ghostwave, you arrive in orbit of the abandoned Thothid station."

Planeside, or as players explore large space stations, the GM need only summarize the times between meaningful encounters: "The bloody encounter with the mercenary group was brutal and short, several hours later you find that you have reached the abandoned outpost. As expected, the mercs have set up camp here and were expecting company."

In times of crisis, urgency, and danger it is important to understand time down to the minute. In cases where meaningful time debt is incurred it is important to know how long the adventurers were taken out of the galaxy in reference to Aeon Time.

Speed

Every character, creature, and mobile machine has a speed, which is the distance in meters that it is able to cross in 1 round. This number is not a scale of overland travel, it is the distance the entity can cover in short bursts of energetic movement at times of danger or excitement.

However, when traveling greater distances, the following rules determine how far a character, creature, or vehicle can move in a given span of time, usually hours.

Space Travel Pace

In space, the speed of adventurer's transit is limited by their mode of transportation. The method of interplanetary travel varies, with a range of electromagnetic and ionic propulsion systems being used for subluminal travel and planetary landing and takeoff.

For interstellar travel, this is accomplished exclusively through the Horizon Drive, a mechanism that moves an area of spacetime relative to its origin at superluminal speeds. Most production Horizon Drives are rated in terms of lightyears per hour, with around 0.3 Ly/h being the most common commercial drive speed. Spaceships generally operate 24 hours a day, and will continue a course, even a superluminal course through autopilot or inertia. While some ships might be an order of magnitude faster, this means that even the fastest Horizon Dives could take months or years to reach the farthest edge of the Arc.

While traveling via Horizon Drive ships are enclosed in an effect called Horizon Space. This phenomenon shrinks some of the extant dimensions of spacetime through the creation of artificial gravity like manifolds of non-Euclidean spacetime topology. Horizon Space is dangerous without proper protection, direct exposure outside of a properly shielded ship causes severe radiation exposure and Hawking radiation changes properties and becomes ionizing and photons gain mass.

Between the speed and the dangers of attempting EVA, supplies and provisions aboard ships become critically important. No adventurer wants to run out of food, water, or air in deep space or risk certain death by attempting repairs outside of a KZM shield.

Transport Travel Pace

On a planet most adventurers will have access to vehicles that allow for rapid transit; cars, planes, jets, and shuttles are common on all but the most savage worlds. A method of



transportation being piloted by a player becomes increasingly difficult to control depending on their travel pace.

Overland Travel Pace

In the rare case where adventurers are forced to march overland for extended periods, a group can move at a normal, fast, or slow pace. A fast pace makes characters less perceptive, while a slow pace makes it possible to sneak around and to search an area more carefully.

Forced March. Characters traveling overland can push on beyond their limits at the risk of exhaustion. For each additional hour of overland travel beyond 8 hours, the characters cover the distance based on their pace. At the end of the hour, the characters must make a Constitution check with a DC of 10, +1 for each hour past 8. On a failed saving throw, a character suffers one level of exhaustion (see Appendix A).

Mounts. For short spans of time (up to an hour), many animals move much faster than humanoids. A mounted character can ride at a gallop for about an hour, covering twice the usual distance for a fast pace.

Travel Paces

Fast. At a fast pace, characters are at -5 penalty to passive skill checks related to vehicle operations or noticing the environment and have Disadvantage to active skill checks. Piloting checks are made with disadvantage. Overland, a party can cover 8 kilometers per hour at a fast pace.

Normal. At a normal pace there are no modifiers or penalties. Overland, a group can cover 5 kilometers per hour.

Slow. By traveling at a slow pace, characters and vehicles can employ stealth. Traveling overland, the party can only cover 1 kilometer an hour.

Difficult Terrain and Turbulence

The travel speeds for creatures and vehicles assume relatively simple terrain: clear skies or roads, wide station corridors, or empty space. The conditions are rarely so good for adventurers who usually must deal with ancient ruins, derelict ships, chaotic plasma storms, and unknown cosmic phenomena.

In difficult terrain or turbulence, you move half your normal speed, so you can cover only half the normal distance in an hour you would normally traveling at the same pace. Traveling at a Fast Pace through Difficult Terrain or Turbulence might even carry the added risk of accident.



Modes of Movement

Most adventurers don't spend their careers on leisurely strolls. You will often have to run, jump, climb, drift in zero gravity, and dive into dangerous waters.

Climbing, Swimming, and Crawling

While climbing or swimming, each meter of movement costs 2, effectively your movement speed as halved, unless a creature has a climbing or swimming speed. At the GM's option, climbing a slippery vertical surface or one with few handholds requires a successful Strength (Athletics) check. Similarly, gaining any distance in rough water might require a successful Strength (Athletics) check.

Jumping and Leaping

Your Strength score dictates your basic ability to leap and jump.

Long Jump. When you make a long jump, you cover a number of meters up to 1/3rd your Strength score if you can make a running start for at least 1/3rd your total movement. From a standing start, you are only able to leap half that distance. Distance covered by a leap counts against your total movement.

With a long jump, the height of your jump generally doesn't matter, such as leaping between two buildings. However, if you find the need to vault over obstacles and maintain your speed, you must succeed on a DC 10 Strength (Athletics) check to clear a hurdle taller than a quarter of the jump's distance. Otherwise, you hit the obstacle.

When you land in difficult terrain, or your distance leaped would exceed your total movement, you must succeed on a DC 10 Dexterity (Acrobatics) check to land on your feet. Otherwise, you land prone.

High Jump. When you make a high jump, you leap into the air 1 meter + 0.3 meters per point of your Strength modifier if you move at least 3 meters on foot immediately before the jump. From a standing high jump, you can jump only half as high.

In some circumstances, your GM might allow you to make a Strength (Athletics) check to jump higher than you normally can.

During a jump you can extend your arms half your height above yourself, meaning you can reach above you a distance equal to the height of the jump plus 1½ times your height.

Flight

Some creatures have an innate ability to fly or glide. Creatures with this capacity can at times cover a greater distance or ignore obstacles on the ground, however, unless a creature has the ability to hover, they must also continue to move to stay aloft.

The GM may require you to make a Strength (athletics) or Dexterity (acrobatics) check to maintain altitude in strong winds or storms, or if you are close to an explosion while flying. A failed roll indicates you plummet to the ground.

Creatures with a flying speed may move in micro gravity if there is also an atmosphere at their flying speed and do not suffer the movement penalties normally associated with micro gravity.

THE ENVIRONMENT

New worlds, ancient ruins, and derelict stations - adventuring in the Arc is wrought with danger and wonder. Regardless of what your mission is, you must always be aware of the environment, a key factor that can mean the difference between life and a rather gruesome death while exploring space.

Gravity

One of the dangers that adventurers face is gravity. Be it the crushing forces of accelerating in a rocket or a fall from a great height, gravity is a danger to all adventurers. Gravity is measured in gs - with 1g being equal to earth's acceleration of $9.8m/s^2$ at surface. Gravity has a fall of equal to the square of the distance, meaning that from several thousand kilometers away, something small won't be meaningfully affected by the gravity of a planet or star. This is called

Micro Gravity, and when people talk about zero gravity this is what they mean. Gravity is usually measured in one of five categories

Micro-Gravity. Anything less than 0.1 g is considered microgravity. Each meter of movement in micro-gravity costs 2.5 meters of your movement speed, and a creature will continue along a trajectory if they push off until an external force stops them. Transitioning from micro gravity to medium gravity requires a Dexterity (Acrobatics) check or be knocked prone.

Low Gravity. Anything less than 0.6g is considered low gravity. In low gravity a creature can leap twice as high and as far, and speed is increased by half, rounded down. Creatures can take fall damage from leaping too high or far, however.

Medium Gravity. Anything up to 1.6 g is medium gravity. All movements and rules operate normally at medium gravity.

High Gravity. Gravity of 3g or less is high gravity. Speed is halved, and encumbrance is doubled. Jumping and leaping distance is also halved. Ranged projectile weapons have half the normal range.

Extreme Gravity. Gravity above 3g becomes dangerous. Each 1g above 3 causes 1d4 bludgeoning damage per minute, and doubles encumbrance. Each round walking above 4g without protection causes one level of exhaustion. Most creatures cannot walk above 6g and must crawl. Projectile weapons have 1/4 range.

Falling. When a creature falls from a great high in a natural or artificial gravity well, it takes damage. At the end of a fall, a creature takes a dice of bludgeoning damage for every 3 meters it fell, based on the gravity well it is in. The creature lands prone, unless it avoids taking damage from the fall.

Gravity well	Fall damage
Micro-Gravity	1 point
Low Gravity	d4
Medium Gravity	d6
High Gravity	d10
Extreme Gravity	d20

Recovery in Microgravity

Severe injury is extremely life threatening in microgravity. Without the force of gravity, wounds are difficult to heal as the hemostatic phase of platelet production and inflammation are impaired. When a creature is reduced to 0 hit points in microgravity, they cannot be stabilized

through normal first aid and an advanced trauma patch is necessary. Without this, the creature will continue dying until returned to at least low gravity.

Collisions

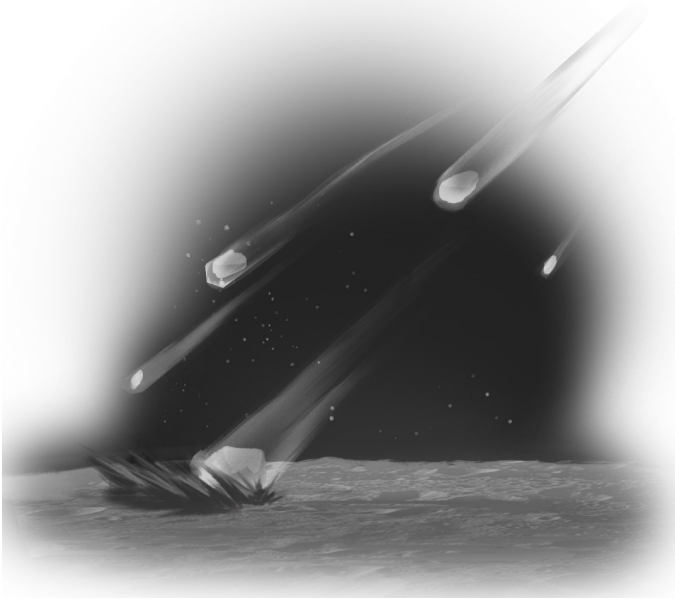

When two bodies collide in, both take damage. This can happen when hover-car rams into a door, when a character in microgravity hurtles into an obstacle, or a rogue asteroid hits your ship. Super high velocity kinetic weapons have their own damage, and these rules should be used for non-weapon impact damage.

Vehicles. When two vehicles collide, or when a vehicle collides with a relatively stationary object, both take 1d10 impact damage per 20km/h of the fastest. For example, if a shuttle traveling at 200km/h were to ram a slow-moving frigate traveling only 50 km/h, both would take 10d10 damage.

Objects. If a piece of debris strikes a vehicle or creature, it deals one dice of impact damage per 50km/h of speed, based on its size. The object damage table indicated the impact damage per size category.

Object Size	Damage dice
Tiny	d4
Small	d6
Medium	d8
Large	d10
Huge	d12
Gargantuan or larger	d20

Vacuum

In the depths of space, there are several situations that can expose a character to the thing that surrounds them constantly – the hard vacuum of space. The dangers of the vacuum include rapid decompression, vacuum exposure, and radiation.

Explosives in Space

Virtually all high yield chemical explosives and thermotic agents are self-reactive or self-oxidizing, meaning virtually all can function in space. Firearms, grenades, missiles, and bombs all function in a vacuum.

Decompression

Most creatures suffer when their bodies go from extremely high pressure to extremely low pressure very quickly, this is called decompression, and can result in decompression sickness.

Type I. Characters who are forced to undergo rapid pressure loss of less than 1 atmospheres of pressure, such as being thrown into space suddenly, or suddenly accelerating into the upper atmosphere, must make a Constitution saving throw DC 15 or suffer 2 levels of exhaustion (see appendix A).

Type II. This is extremely dangerous, can be caused by rapid changes in pressure of more than 2 atmospheres, such as ascending from deep water minutes, flying from sea level to near space in just a few minutes with no pressure suit, or being jettisoned from a high-pressure spaceship into space. In this case the character must make a DC20 Constitution saving throw or suffer 3 levels of exhaustion. Each hour until they are treated by a Medicine Check DC 15, they must make another save or add 1 level of exhaustion (see appendix A).

Suffocating

A creature can hold its breath for 1 + its Constitution modifier minutes, with a minimum of 30 seconds. A creature which is suffocating, or choking, can survive for a number of rounds equal to its Constitution modifier +1. After this, it drops to 0 hit points and it can't regain hit points or be stabilized until it can once again breathe.

Suffocation is terrifying and distracting. Once a creature begins to suffocate, it must make a Wisdom Saving throw with a DC 20 or begin to panic, incurring disadvantage on all tasks requiring concentration or delicate work.

Vision and Light

Sight is one of the most relied upon sense for adventurers, regardless of their species. You must be able to see to notice danger, interact with a computer, or strike an enemy. This means being blinded can prove a significant hindrance.

A given area might be lightly or heavily obscured. In a lightly obscured area, such as dim light, patchy fog, or moderate foliage, creatures have disadvantage on Wisdom (Perception) checks that rely on sight.

A heavily obscured area such as darkness with no assistance, opaque fog, or dense foliage blocks vision entirely. A creature effectively suffers from the blinded condition (see appendix A) when trying to see something in that area.

The presence or absence of light in an environment creates three categories of illumination: bright light, dim light, and darkness.

Bright light lets most creatures see normally. Anything above 500 lumens of local light, or about 40 candelas, such as most lamps and passive emergency lights, is bright light. For a star with the same luminosity as the sun, you would have bright light on the surface of an object out to about 9 AU – close to Saturn, in earth's solar system. You will find bright light from most artificial light sources of illumination within a specific radius.

Dim light, also called shadows, creates a lightly obscured area. An area of dim light is usually a boundary between a source of bright light, such as a lamp, and surrounding darkness. The soft light of distant stars and glow of a brilliant moon or nearby gas giant, and anything below the 500 lumens mark, qualifies as dim light.

Darkness creates a heavily obscured area. Night, the shadow of any celestial body, and the depth of interstellar space are all areas of darkness. The darkness of deep space is utter and complete, even while billions upon billions of stars are visible, and only a tiny fraction of light reaches things in the depth of the void.

Blindsight

Some alien creatures can perceive its surroundings without relying on sight, within a specific radius. This may be echolocation, thermal or infrared vision, or even an acute electromagnetic sense.

Darkvision

Many creatures have Darkvision – the ability to see the near infrared range of light. Within a specified range, a creature with Darkvision can see in darkness as if the darkness were dim light,

so areas of darkness are only lightly obscured as far as that creature is concerned. Because of the limited spectrum observed with Darkvision, a creature can't discern color only values – shades of gray.

Food and Water

Creatures forced to endure without enough food and water will suffer the effects of exhaustion (see appendix A). Exhaustion caused by starvation and dehydration can't be overcome until the creature eats and drinks the full required amount.

Food

A character needs 0.5kg of food per day at regular exercise and exertion levels. A character can go without food for a number of days equal to 3 + his or her Constitution modifier (minimum 1) while active and using energy. A character who spends more than half their day resting can survive on half this amount. Characters can also stretch food by eating only half rations. Each day at half rations counts as half a day without food.

At the end of each full day beyond their limit, a character automatically suffers one level of exhaustion caused by starvation. A normal day of eating resets the count of days without food to zero.

Water

A character needs one liter of water per day to survive, or two liters per day if they are very active or the average temperature is above 32 degrees Celsius. A character who drinks only half that much water must succeed on a DC 15 Constitution saving throw or suffer one level of exhaustion at the end of the day. A character with access to even less water automatically suffers one level of exhaustion at the end of the day.

If the character already has one or more levels of exhaustion, the character takes two levels in either case.

INANIMATE OBJECTS

The team assembles to either side of the inner airlock, the only light comes from the red blink of the thermal detonator attached to the airlock's main mechanism. A silent flash, and debris is blown out into space with explosive force.

Characters will find they often need to blow-up a wall, smash through a door, and obliterate a control panel for one reason or another. Characters armed with modern weapons and explosives can destroy virtually anything, but they might find that they run out of ammunition

before they can make a hole in a concrete bulkhead or cut through a docking clamp with a laser pistol.

The rules below describe objects on a component scale such as a control panel, lock, energy weapon, not a building or a vehicle that is composed of many discreet components. However, destroying the right component of such larger structures can have cascading effects that damage much more than just the target object.

Object Statistics

Character's trying to destroy something with a time limit will find they need to hit the target and damage it's hit points sufficiently. Some items may have vulnerabilities, immunities and resistances based on its composition.

Armor Class. Generally, objects cannot dodge, and have no Armor Rank. Instead, an object's Armor Class measures how difficult it is to deal damage to it with a weapon. This Object Armor Class table provides AC values for various compositions. The AC of a moving object, such floating in micro-gravity or falling should be +2 for slow speeds, and +4 for high speeds relative to the attacker.

Object Armor Class

Composition	AC	Example
Flexible organic	11	Cloth, paper, rope
Weak crystalline	13	Crystal, glass, ice
Fragile composite	14	Consumer electronics
Rigid organic	15	Bone, hardwood, chitin
Strong composite	16	Ship component, concrete
Strong crystalline	17	Stone, poly-ceramics
Metallic crystalline	19	Iron, mild steels
Metallic Polymer	20	Hardened steels, alloys
Nano crystalline carbon structures	21	Powered melee weapons, reactor casing
KZM alloys	23	Protogen artifacts, neutronium metals

Hit Points. Object's ability to sustain damage is rated by hit points just like a creature. Once an object's hit points reach 0 it is damaged beyond any ability to function, and possible beyond repair. The hit points of any object depend largely on the composition and size.

Object Hit Points

Composition	Small	Med.	Large
Flexible organic	1d4	1d8	1d12
Weak crystalline	1d4	1d8	1d12
Fragile composite	2d4	2d8	2d12
Rigid organic	4d4	4d8	4d12
Strong composite	5d4	5d8	5d12
Strong crystalline	5d4	5d8	5d12
Metallic crystalline	6d4	6d8	6d12
Metallic Polymer	7d4	7d8	7d12
Nano crystalline carbon structures	10d4	10d8	10d12
KZM alloys	15d4	15d8	15d12

Objects and Damage Types. Unless explicitly stated otherwise, inanimate objects have immunity to poison and psychic damage. Additionally, objects can have different interactions based on their composition, as outlined below. These are general guidelines, and specific materials with specific compositions mad material make ups will have radically different properties.

Object Composition

Composition	Immunity	Resistance.	Vulnerability
Flexible organic	Bludgeoning	Radiation	Thermal
Weak crystalline	Electrical	Corrosive	Impact
Fragile composite	--	--	Electrical
Rigid organic	--	Slashing	Thermal
Strong composite	--	Sonic, Bludgeoning	--
Strong crystalline	Corrosive	Electrical	--
Metallic crystalline	Electrical	Slashing, Piercing	--
Metallic Polymer	Electrical	Slashing, Piercing	--
Nano crystalline carbon structures	Slashing, Piercing, Bludgeoning	Thermal, Electrical	--
KZM alloys	--	All	--

Massive Objects. When a complete homogenous object is Huge or Gargantuan, most normal forms of attack are completely meaningless against it. Such colossal structures, like ancient monuments, blast shelter walls, and monumental natural statures are only meaningfully damaged when an attack is capable of overcoming the structure's Damage Threshold. Composite objects have hit points broken out by section or component part. Vehicles, including spaceships and mechs are handled separately.

Damage Threshold. Massive defensive structures, natural features, and otherwise enormous objects have a degree of immunity to attack represented by a damage threshold, an amount of damage an attack must exceed in order to effectively deal damage. An object has immunity to all damage unless a single attack or effect deals damage equal to or greater than its damage threshold. If the attack deals damage greater than the object's damage threshold, it takes all the damage as normal. Any damage below the object's damage threshold is ignored.

REST AND RECUPERATION

Even the most intrepid adventurers need time to recover. Every day can't be back to back conflicts, discoveries, and dangers, they need time to sleep and eat, mend wounds, check equipment, and mentally prepare themselves for the next sortie.

When a group of adventurers takes a break, it is either a Short or a Long rest.

Short Rest

At least 1 hour long, this downtime can be spent having a meal, performing maintenance, meditating, reading, or doing light training. To take a short rest, characters must be reasonably safe, but can maintain a state of active guard.

During a short rest, a character can 'spend' one or more Hit Dice, up to the character's maximum Hit Dice based on character level. Each Hit Die spent is rolled plus the character's Constitution modifier, and the character regains this many hit points. Characters with multiple types of hit dice choose which they wish to roll when they elect to spend them in this way, up to the maximum number of hit dice of that type. Following a long rest, some of these spent hit dice will be recovered.

Long Rest

This is an extended break from action, at least 8 hours. To reap the benefits of a long rest, a character must be in a safe and secured location,

and only engage in very light activity such as meals, light conversation, or sleep.

Characters can stand watch for no more than 2 hours, and should the rest be interrupted by a period of strenuous activity such as a 1 hour of hiking, more than a few rounds of combat, or other stressful adventuring activity they must begin the rest again to gain any benefit from it.

At the end of a long rest, a character regains all lost hit points and half of the character's total number Hit Dice, if any were spent for recovery during short rests.

It's impossible to benefit from more than one long rest in any 24-hour period, and a character must have at least 1 hit point at the start of the long rest to gain any benefits.

DOWNTIME

Space is vast, and the Arc is huge. As adventurers journey to distant worlds, await the arrival or repair of their transportation, or simply wish to take a well-earned vacation you will find that you must deal with periods of downtime, where the players are engaged in rest, recuperation, and preparation for future missions.

Preparation can take many forms, such as crafting equipment, researching information, or developing contacts and connections. Some adventures might simply like to go shopping.

When the players have no activities during their downtime, it occurs with little fanfare or description. As you begin a new adventure, you might simply declare that a certain amount of time has passed briefly gloss over what the characters have been doing. As the GM, you may want to keep track of this time passing, as events in your campaign unfold and move while the adventurers rest up and eat shawarma.

Lifestyle Expenses

Between missions, the adventurers pay the cost of maintaining their choice of lifestyle. While this may have little effect on day to day life, it will directly impact their ability to engage in other activities, such as training or networking. Adventurers may wish to practice their profession to support their standard of living and earn some additional Credit as well.

Downtime Activities

When giving the adventurers downtime, remember to ask if there are any activities they wanted to do. Lost equipment needs to be replaced, interesting tidbits of information explored, and new skills mastered.

Downtime has no fixed duration - it could be a month or a year - but downtime activities each requires a certain number of days to complete before you gain any benefit, and at least 8 hours of each day must be devoted to the downtime activity for the day to count.

For most activities, days do not need to be consecutive. If you have 30 days of down time, you could do any activity in any order as long as the minimum number of days were spent on the activity.

Downtime activities other than the ones presented below are possible. Be sure to discuss with your players what they want their character's activities to be during lengthy downtime.

Crafting Equipment

During your down time you can create ordinary equipment, mods, and works of art. Crafting most equipment requires access to specialized tools and equipment, such as fabrication facilities or a laboratory, and the skills and tool proficiencies to use them. These rules assume that all parts are generally quite custom, having been manufactured by the character.

Cost

Materials require a Credit check against $8 + \frac{1}{4}$ the item's Credit modifier, round down, with a minimum of 1. Some items may also have materials with limited availability as decided by the GM. If so, add the availability modifier.

Time

The time it takes to create a piece of equipment assumes that the character is fashioning the major components themselves, and not simply assembling a manufactured device. The number of solar days necessary craft equipment such as weapons, armor, and kits will equal the base Credit modifier of the item being crafted. A knife with a Credit modifier of +1 will take 1 day, and a powerful rifle with a Credit modifier of +8 will take more than a week. These solar days assume that you work for 8 hours in that day with relatively few interruptions.

Vehicles, ship scale weapons, and most tools require 10 times as long. A small car would require 40 days, where as a spaceship would require more than two years.

Provided that the characters all have requisite proficiency and are working together in the same place, multiple characters can combine their efforts toward the crafting of a single item. Each worker contributes each day spent helping to craft the item. This means two engineers could build a car in just 20 days.

The maximum number of meaningful contributors to a build is equal to its Credit modifier, meaning that only 2 people can contribute on a knife, getting it done in 1 day, and only 4 people can work on building a car at the same time.

Skills

Crafting equipment requires proficiency in several skills and tools. To successfully craft an item, you must make a DC 15 proficiency check successfully each day. On a day that your roll fails, or you choose not to roll, you fail to make any progress, and must begin again tomorrow. What proficiencies are specifically required depends on the item, as shown below.

Acids. Sciences, Organic Chemistry, Laboratory.

Artwork. Artists Supplies.

Aircraft. Piloting, Engineering, Fabrication Tools.

Ancient Armor. Fabrication Tools.

Ancient Weapons. Fabrication Tools or Carpenter's Tools.

Cybernetics. Sciences, Medicine, Laboratory.

Drugs or Poisons. Medicine, Laboratory

Energy Weapons. Engineering, Computers, Sciences, Fabrication Tools.

Explosives. Science, Chemistry, Laboratory.

Firearms. Engineering, Fabrication Tools.

Heavy Weapons. Engineering, Fabrication Tools.

Instruments. Instrument Proficiency, Performance, Carpenter's Tools or Fabrication Tools.

Kits. Proficiency with the target Kit.

Mecha. Engineering, Robotics Expert, Computers, Fabrication Tools.

Power Armor. Engineering, Robotics Expert, Computers, Fabrication Tools.

Powered Weapons. Sciences, Fabrication Tools.

Railguns. Engineering, Computers, Sciences, Fabrication Tools.

Spacecraft. Piloting, Engineering, Computers, Sciences, Fabrication Tools.

Software. Computers, Programming.

Surface Vehicle. Engineering, Fabrication Tools.

Tactical Armor. Sciences, Fabrication Tools.

Tools. Tool proficiency, Bureaucracy.

Mastercrafting

Characters with the Mastercraft feat can create modern weapons, armors, and tools of vastly superior quality.

Mastercrafted armor receives a bonus to

either Armor Class or Armor Rank. Weapons which are Mastercraft provide a bonus to either attack or damage rolls. Tools that are mastercraft provide a bonus to relevant proficiency checks. A mastercraft bonus ranges from +1 to +3 bonus, and items are limited to one mastercraft bonus.

Cost. Crafting an item of superior quality takes more time and better resources. The Credit check necessary to purchase the components is increase by the intended mastercraft bonus (+1, +2, +3).

Time. The time necessary to create a piece of mastercraft is twice the item's Credit modifier, plus the mastercraft bonus. Large workshops and vehicles require ten times as this value. Only one craftsman may work on a mastercraft item at a time, and all craftsmen who contribute must have the Mastercraft feat or the effort is wasted, and the item is not mastercrafted.

Skills. In addition to the Mastercrafter feat and the normal prerequisites, each day the craftsmen must succeed a Proficiency check DC 15 + item's mastercrafted bonus.

Practicing a Profession

Adventurers had jobs before venturing out in to space on daring mercenary missions. Most are still perfectly capable of practicing this trade, or some freelance variation of it, allowing them to maintain a modest lifestyle without worry if their Credit modifier is less than +8. This benefit lasts as long they continue to practice their profession.

If the adventurer has a Credit modifier is +8 or higher, they can earn enough to support a comfortable lifestyle.

Adventurers that are already quite well off, with a Credit Modifier of +15 or higher can maintain a wealthy lifestyle if they work during their downtime.

Finally, if a character chooses to live frugally while working, they instead gain +2 additional Credit at the end of each month of down time where they work and live at a lower standard than their Credit modifier would allow.

Recuperating

Characters who suffer significant injuries or ailments can use this time to recover and rest. After three days spent recuperating, they can make a DC 15 Constitution saving throw. A successful save allows them to choose one of the following:

- Remove all levels of exhaustion
- Gain advantage on saving throws against one disease or poison they are currently afflicted with

Researching

Intel is essential to successful mission, developing connections, and driving the campaign forward. Smart players will want to research subjects and hints that have been left for them during their sorties.

Research takes many forms – hours on hours of reading on the Astral Net, chatting up contacts or reaching out to connections, or even hitting the streets and gathering information from the locals.

If your players wish to do some digging on a specific subject, first decide whether the information is available, how many days of downtime it will take to find it, and whether there are any restrictions on accessing this information (such as needing to seek out a specific contact, access privilege, or location).

Depending on the source and scope of this information, you should require more ability checks, such as an Intelligence (computers), Wisdom (Medicine) or Charisma (Persuasion). If the character is reaching out to their networks and contacts heavily, require a Reputation check.

If they are successful, inform the players if the information is available, and what they will need to do to secure it, such as pay a bribe, or perform some experiments.

For each day of research, you must make a DC 10 Credit check, as you use resources to acquire this information.

Training

Finally, players might use their downtime to improve themselves by learning a new language or training with a set of tools to gain proficiency. At your discretion you might allow a player character to become proficient in one specific ancient or modern weapon, or one specific suite of ancient or tactical armor.

However, the character needs find an instructor willing to teach them. The more unusual the skill or ability the longer it should take. Finding a person to teach Colonial common, or to use a handgun might only take a day. Finding a teacher fluent in Quithal or Security Kits might take more than a month, and one or more ability checks might be required.

The training lasts for 240 days and has a Credit modifier of +2. A Credit check required each month. After you spend the requisite amount of time and money, you learn the new language or gain proficiency with the new tool.

SECTION 10 SPACESHIPS

The void, an unending ocean of stars, cold and burning, filled with ancient worlds and new born stars. Many of your adventures will take place in the space between planets and star systems. Derelict stations and mysterious moons, you will face untold threats, unexpected events, and incredible discovery in the darkness of space.

SPACE TECHNOLOGY

Several technologies make regular space travel possible for the civilization of the Arc. Some are familiar to us even today, others, push the bounds of science as we know it into the realm of the seemingly impossible.

Artificial Gravity

Something of a mischaracterization, inside large ships and stations low power graviphoton emitters are used to generate comfortable gravity. This same technology can be used to create tight gravity beams to attract objects, or in extremely powerful energy weapons.

Weaponized Gravity

Clever players will quickly hit on using artificial gravity as a weapon. After all, what better way to disable a hostile boarding party than to crank the gravity up to 4g?

Gravity generation relies on creating exotic photons with gravity like properties, and the energy necessary increases logarithmically. Even with energy, the emitters may simply fail. Generally, a ship's artificial gravity can be tuned between 0 and 1.4g. Without the gravity on, there is no artificial inertia, so accelerating at high speeds might kill everyone on board.

Electromagnetic Propulsion

The primary method of propulsion used throughout the Arc generates thrust via radio-frequency cavity resonance. Microwaves are beamed into a superconductive cavity and exposed to specialized modulated magnetic fields. As a result, along the vector of the initial radio wave quantized inertia builds up generating forward momentum.

For subluminal space travel this propulsion is generally perfect. It has high specific impulse, medium thrust, and high weight to thrust ratio. Powerful version can even be used for planetary lift off when coupled with graviphoton emitters.

Horizon Drives

With the ability to cross huge distances in the blink of an eye, the galaxy was forever changed. Before the arrival of Horizon Drives, space travel was limited to relativistic speeds and naturally occurring traversable wormholes.

The Horizon Drive is an extension of the KZM Shield technology. By modifying the stress-energy tensor of the forward face of the shield, it is possible to contract the forward space and expand the rear space by an inverse square through gravity-like manifolds. The surface topology around the ship shrinks to a fraction of the normal size and stretches. As the forward curve geodesic grows, it approaches the advent horizon - the point where the tachyon condensation of graviphotons generates enough negative energy to displace the Horizon Space at super-luminal speeds.

Horizon Space

The Horizon Drive creates small fold in space, and then moves that fold along a predetermined course, this is known as Horizon Space. Inside Horizon Space the ship is completely isolated from the universe beyond, except through quantum communication. However, a secondary KZM Shield is needed inside to protect the ship from exotic particles and Hawking radiation that cannot exist in normal spacetime. In the strange dimension of Horizon Space Hawking radiation will ionize normal matter, photons gain mass, and muon decoupling causes entropy to reverse in some cases. As the Horizon space accelerates through normal space, the bow shock of the bubble creates excited fields and strange phenomena that can be extremely dangerous.

In Horizon space the cross section of the topological bubble is a fraction of the size of the ship. Furthermore, the vessel never moves, only the spacetime in the fold. Unlike classical acceleration, there is no momentum, and no kinetic energy. Objects encountered by the path of the Horizon Space fold move around and between, this makes ramming via Horizon Space meaningless. However, exiting Horizon Space inside a larger mass can potentially violently separate the two spacetimes.

Speed

Horizon Drives are rated at Lightyears per hour before cascade failure, between 0.1 for the simplest drives and 5 for the fastest possible machines. This is the maximum displacement the drive can reach before the buildup of exotic particles and energy inside the Horizon Space causes the field to destabilize, potentially obliterating the ship and everyone on board.

Spool

Horizon Drives do not activate instantly. The faster the intended displacement, the longer the spool up. It takes 1 round for every 0.1 Ly/Hr of the target displacement speed to achieve the advent horizon. While the field is spooling, the ship is vulnerable to attack and cannot move.

KZM Shields

With the advent of ships capable of speeds fractional to the speed of light, a mechanism was needed to protect these vessels from heavy ions and random particles in space. Even a single hydrogen atom in the interstellar void could destroy a ship traveling at 1% the speed of light. This technology is the Kibble-Zurek Mechanism field line emitter, or KZM Shield. A KZM Shield

creates a topological defect along a set curve of space through excitation of the quantum vacuum energy, causing it to take on characteristics of quantized inertia. As matter and energy pass into the field of the KZM Shield, their specific inertia is bent along the lines of the shield. This allows for ships to travel at relativistic speeds and plays a critical role in the formation of the Horizon Drive.

An active KZM Shield provides significant protection as additional hit points and resistance to radiation, thermal, and electromagnetic damage. For example, a 25-point KZM Shield should can absorb 25 points of damage from incoming attacks. Further, if that damage was Radiation, the damage would be halved first. However, a shield has limits. Once all of the shield's hit points are gone, the shield emitters blow out until they can be repaired with a DC 15 check.

Wormholes

Since the birth of their civilization, the Xhu Akreen and Thothid have relied on network of ancient proto-gen artifacts that used powerful graviphoton arrays to stabilize microscopic wormholes. It took them centuries, but they eventually reverse engineered the device and found that they could exploit naturally occurring wormholes to travel across the galaxy. However, this mode of transit is extremely limited.

First, each end of the corridor requires a device to stabilize that opening for transit, a voyage from a stabilized end to an unstable end is a one-way trip. Second, natural wormhole phenomena are rare and extremely dangerous, the gravitational eddies and exotic radiation that accompany traveling through these corridors will cause severe damage to unprepared vessels. Finally, time dilation can cause each end of the wormhole to become far enough out of sync that it is possible to travel in time, with devastating consequences.

Traversing a wormhole forward in time causes time debt, but that is not a danger, traversing a wormhole backwards in time causes self-consistency symmetry to erode the information of the atoms as they build up negative time. As this erosion occurs, atoms break apart causing bursts of exotic particles and neutrino radiation, destroying anything that builds up more than a few picoseconds of negative time.

Exploiting wormholes for space travel has disappeared in recent centuries as Horizon technology has spread through the Arc, but some ancient gateways are still held by the Magisterium.

SPACESHIPS

The most powerful and advanced equipment characters will acquire throughout their careers as adventurers are interstellar spaceships. In Advent Horizon, rapid interstellar travel is one of the cornerstones of the setting, but spaceships are not cheap.

Beyond transportation, these vehicles have the capacity to harbor armaments that can devastate a city in moments. The GM should give these heavily armed and armored vehicles to the players sparingly. A party should earn sole command of this equipment, and only one or two should be available to players at any time. It's not unreasonable for the players to have an interstellar yacht, but not a heavily armed dreadnought.

Regardless of the ship's class or modifications, all spacecraft share the following features:

- Biometric Lock that identifies up to 4 executive crew, and can uplink to an unlimited number of mobiles.
- Onboard terminals for each crew station
- Onboard AV system and control computer with wireless uplink
- Onboard systems information which displays the general condition of the vehicle
- Life support systems with air-scrubbers, and temperature controls
- A Fusion Plasma field generator for long-term electrical power supply
- Electromagnetic Propulsion thrusters

Proficiency. When you are proficient in Piloting you can operate a Helm station with up to one sub system; virtually all yachts and shuttles outlined below. You add your proficiency check to rolls to perform maneuvers with these ships, and you can perform basic repairs with a successful Intelligence (engineering) check. To take the helm of more sophisticated ships requires additional proficiency. Advanced Piloting allows you to add your proficiency bonus to checks on helms with up to three sub systems, and Elite Piloting allows you to add your proficiency bonus to checks on helms with up to five subsystems. Capitol piloting can also control up to five subsystems so long as they are not tactical stations.

Armor Class. Each ship has a base armor class for a ship on autopilot, this is both how hard it is to hit and damage. Pilots proficient in Combat Maneuvers can add their proficiency bonus to their ship's Armor Class.

Hit Points. While spaceships are enormous conglomerates of parts, they have hit points just like creatures. When a ship reaches 0 hit points it is disabled, and damage control is needed or the

ship will be destroyed. Because they are so large, many ships also have sectional hit points for each 3 meter square of the outer hull, Hull HPs. When a section of the hull reaches 0 hit points there is a hull breach that can be potentially fatal to those inside.

Damage Threshold. Some ships have an amount of damage an attack must exceed in order to effectively deal damage. The ship has immunity to all damage unless a single attack or effect deals damage equal to or greater than its damage threshold. If the attack deals damage greater than the damage threshold, it takes all the damage as normal. Any damage below the object's damage threshold is ignored.

Acceleration. How fast the ship can accelerate and change its vector. Actual acceleration is equal to this number per second squared. The only speed limit in space is the speed of light, but how fast a ship accelerates is also how fast it slows down, after all going a million kilometers per hours is great, but how long will it take to slow down so you don't overshoot your destination, or worse smash into it. A ships speed in combat is equal to this number times 100.

Size. Spaceship's dimensions are listed here.

Crew. This is the minimum compliment needed to operate all the major systems. A ship requires one crew member for each station and each feature. Larger ships regularly have many times this number to ensure smooth operations.

Stations. Ship systems, such as sensors and weapons are controlled from one point, a station. There is a limit to the number of systems that can be controlled at a station, and during the round you can only use one system, or attack with one weapon battery via your station.

Horizon Rating. This rate is the number of light years per hour the ship can displace in Horizon Space.

Features. Special systems and equipment available on the standard make of this ship.

Weapons. The ship's offensive capabilities and number of tactical stations. Weapons can only be controlled from one tactical station.

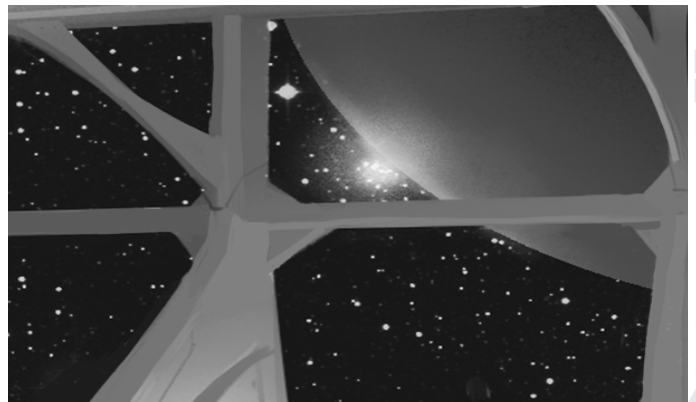

Ship Stations

Stations are terminals which control ship systems. Each system, and each drive type requires a Station. A station can have up to five Systems associated with it.

Cockpit. In single or twin crew advanced ships a cockpit might control the helm, sensors, and weapons, as is common of fighters.

Helm. A helm station controls the electromagnetic drives, the horizon drives, or both. A ship is piloted via the helm.

Engineering. This station usually controls power distribution from the ship's reactors, or systems such as life support and shields.

Communications. A Communications station commands one or more communications packages.

Science. Sensors and sensor arrays tend to be connected to a scientific station.

Tactical. Weapons and active stealth are usually commanded via a tactical station.

Light Spacecraft

Shuttles, yachts, and fighters, light spacecraft are small and maneuverable with a minimal crew. The smallest civilian shuttles and attack fighters may not even have a horizon drive.

Light Shuttle

Most light shuttles are largely identical. These are interstation or interorbit hoppers equipped with weak KZM shields, small thrusters, and no defenses. Light shuttles are relatively cheap to manufacture.

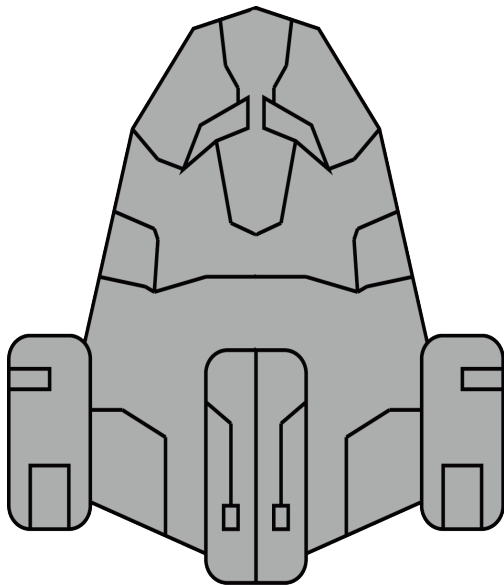

	AC	Ship HPs	Hull HPs	Shields
	10	100	10	5
Proficiency	Piloting			
Acceleration	1 meter			
Horizon Drive	-			
Crew	2			
Passengers	6			
Size	L 20m H 8m W 8m			
Credit	+12 uncommon			
Systems				
Helm	Primary Communications			
Helm	Simple Sensors			
Engineering	Micro fusion reactor			
Engineering	KZM Shield			

Light Freight Ship

Light freight ships are two or three crew ships with large engines and reactors designed for medium interstellar cargo transport. Hundreds of models exist as horizon technology spread throughout the Arc.

	AC	Ship HPs	Hull HPs	Shields
	11	300	25	15
Proficiency	Piloting			
Acceleration	1 meter			
Horizon Drive	0.1ly/h			
Crew	3			
Passengers	2			
Size	L 60m by H 12m by w 20m			
Credit	+19 uncommon			
Systems				
Helm 1	Simple Sensors			
Helm 1	Horizon Drive			
Helm 2	PDC Lasers			
Helm 2	Primary Communication			
Engineering	Micro fusion reactor			
Engineering	KZM Shield			
Cargo 1	48 tons, pressurized			
Cargo 2	360 tons, unpressurized			

Features

Point Defense Cannons.

Corporate FX77 Fighter

The FX77 fighter is the direct decedent of the American Empire's weapons program. It is a fast and maneuverable exo-atmospheric fighter with significant armament capability and speed. Several earlier versions traveled to the outer colonies and were advanced by the corporations.

AC	Ship HPs	Hull HPs	Shields
10	200	20	15
Proficiency	Elite		
Acceleration	40 meters		
Horizon Drive	-		
Crew	1		
Passengers	0		
Size	L 40m H 4m W 16m		
Credit	+44 Restricted		
Systems			
Cockpit	Primary Communications		
Cockpit	Tactical Sensors		
Cockpit	Weapons Array		
Cockpit	KZM Shield		
Cockpit	Macro fusion reactor		

Weapons Array

Light Autocannon, Left Small missile mount, Right Small missile mount

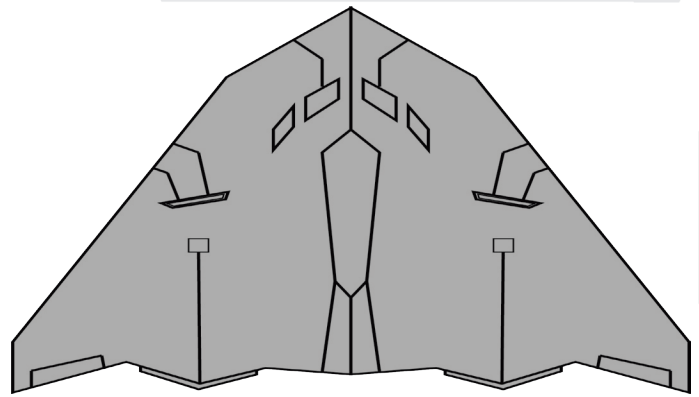
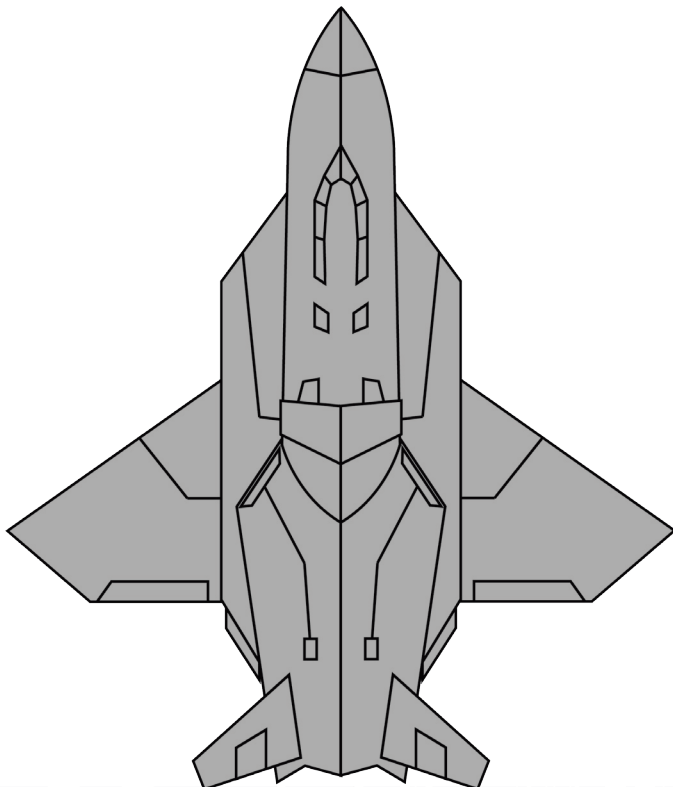

Imperium Shinobi Stealth Fighter

An evolution of Martian stealth fighters, the Shinobi as a versatile multipurpose stealth attack ship capable if both bombing runs and ship to ship combat.

AC	Ship HPs	Hull HPs	Shields
10	200	20	15
Proficiency	Elite		
Acceleration	40 meters		
Horizon Drive	-		
Crew	1		
Passengers	0		
Size	L 15m H 6m W 45m		
Credit	+55 Restricted		
Systems			
Cockpit	Primary Communications		
Cockpit	Tactical Sensors		
Cockpit	Weapons Array		
Cockpit	KZM Shield		
Cockpit	Macro fusion reactor		
Cockpit	Combat Computer		

Features

Atmospheric. The Shinobi can enter an atmosphere at speeds under Mach 3, and perform sustained atmospheric flight, up to that speed.

Stealth. The exterior of the ship is equipped with systems designed to minimize its lidar and radar cross-section. The pilot has Advantage on stealth piloting checks.

Weapons Array

Light Autocannon, Small 4-tube missile pod

Magisterium Patrol Corvette

Built during the Armitage wars, the patrol ship of the magisterium is a recent advent, light horizon capable scout ships with modest combat ability.

AC	Ship HPs	Hull HPs	Shields
14	300	25	15
Proficiency	Advanced		
Acceleration	10 meters		
Horizon Drive	-		
Crew	3		
Passengers	2		
Size	L 30m H 15m W 25m		
Credit	+25 Restricted		
Systems			
Helm	Tactical Communications		
Helm	Tactical Sensors		
Helm	Weapons Array 1		
Helm	Combat Computer		
Tactical 1	Weapons Array 2		
Tactical 1	Combat Computer		
Engineering	KZM Shields		
Engineering	Macro fusion reactors		

Features

Light Armor. The Magisterium Corvette is designed to take significant damage and has a Damage Threshold of 5.

Light point defense cannons

Weapons Array 1

Tactical 1. Front HI light laser cannon

Weapons Array 2

Tactical 2. Right HI heavy laser cannon, left HI heavy laser cannon, right 4-tube small missile launcher, left 4-tube small missile launcher

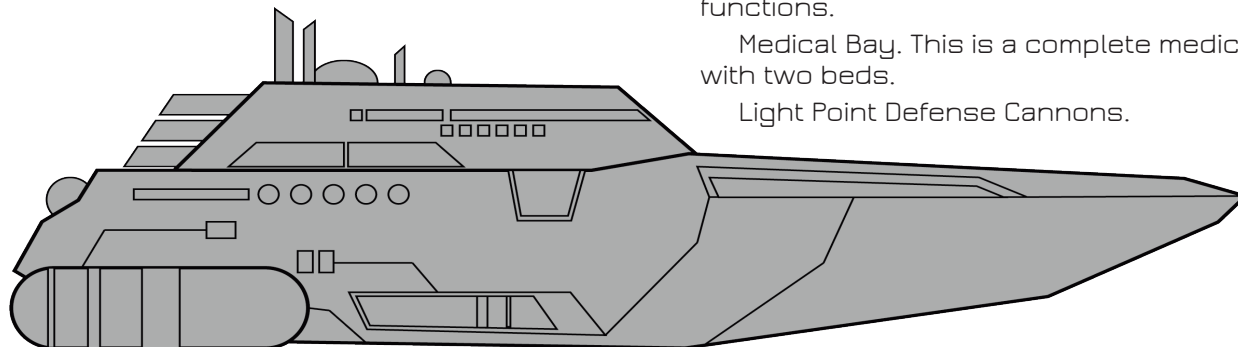

Medium Spacecraft

Frigates, heavy freighters and destroyers fall into this category. Most interstellar craft fall into this classification, and some are even capable of atmospheric entry.

Superyacht

Build for speed and Luxury, this is a standard civilian interstellar ship. While Superyachts can be custom build spacecraft, most are based on corporate models that are mass-produced in the colonies.

AC	Ship HPs	Hull HPs	Shields
11	400	20	30
Proficiency	Piloting		
Acceleration	4.5 meters		
Horizon Drive	0.3ly/h		
Crew	3		
Passengers	10		
Size	L 30m H 15m W 25m		
Credit	+25 Uncommon		
Systems			
Helm	Simple Sensors		
Comms	Primary Communication		
Comms	Astral Node		
Engineering	Macro Fusion Reactors		
Engineering	KZM Shields		
Cargo bay	80 tons, pressurized		

Features

Astral Node. The ship is equipped with a full AstralNet node. This allows the ship's computers and paired devices to access the AstralNet via the ship's node.

Advanced Computer Package. All computers on the ship are networked and any one station can be accessed from another apart from executive functions.

Medical Bay. This is a complete medical facility with two beds.

Light Point Defense Cannons.

Ixaxian Exploration Cruiser

The Ixaxians are a very technically advanced species, and their exploration ships demonstrate this. Outfitted with minimal firepower and maximized for science they can still hold their own against the gunships of the Imperium and Magisterium alike.

AC	Ship HPs	Hull HPs	Shields
12	400	20	30
Proficiency	Piloting		
Acceleration	10 meters		
Horizon Drive	0.3ly/h		
Crew	10		
Passengers	40		
Size	L 240m H 55m W 105m		
Credit	+65 Uncommon		
Systems			
Helm	Simple Sensors, Array 1		
Science	Exploration Sensors, Array 2		
Comms	Advanced Communication		
Comms	Astral Node		
Engineering	Antimatter Fusion Reactors		
Engineering	KZM Shields		
Engineering	Damage Control Drones		
Tactical	Weapons Array		
Tactical	Combat Computer		
Cargo Bay	360 tons, pressurized		

Features

Astral Node. The ship is equipped with a full AstralNet node. This allows the ship's computers and paired devices to access the AstralNet via the ship's node.

Advanced Computer Package. All computers on the ship are networked and any one station can be accessed from another apart from executive functions.

Medical Bay. This is a complete medical facility with four beds.

Engineering Bay. This is a complete fabrication facility.

Science Bay. This is a complete laboratory.

Point Defense Cannons

Weapons Array

Medium HI Laser Turrets, Medium Graviphoton Beam, Light HI Laser Turret, Medium Graviphoton Grapple

Pirate Destroyer

Your typical pirate vessel is a cramped ship designed for maximum fire power, and little else. Most Pirate ships are converted yachts or rebuilt gunships.

AC	Ship HPs	Hull HPs	Shields
13	450	22	60
Proficiency	Advanced		
Acceleration	3.5 meters		
Horizon Drive	0.3ly/h		
Crew	12		
Passengers	10		
Size	L 120m H 44m W 15m		
Credit	+75 Uncommon		
Systems			
Helm 1	Simple Sensors, Array 1		
Helm 1	Tactical Communication		
Helm 2	Simple Sensors, Array 2		
Helm 2	Tactical Communication		
Engineering	Antimatter Fusion Reactors		
Engineering	KZM Shields		
Engineering	Damage Control Drones		
Tactical 1	Weapons Array 1		
Tactical 1	Combat Computer		
Tactical 2	Weapons Array 2		
Tactical 2	Combat Computer		
Tactical 3	Weapons Array 3		
Tactical 3	Combat Computer		

Features

Light Armor. The Magisterium Corvette is designed to take significant damage and has a Damage Threshold of 5.

Medical Bay. This is a complete medical facility with two beds.

Engineering Bay. This is a complete fabrication facility.

Weapons Array 1

Medium Autocannon Turret, 4-Tube Small Missile pod turret

Weapons Array 2

Medium Autocannon Turret, 4-Tube Small Missile pod turret

Weapons Array 3

Ballistic Railgun

Imperium Koschei Destroyer

The Koschei Destroyer is one of the more devastating hunter-killer ships the Imperium of Sol devised. While a heavy armament of kinetic weapons and missiles makes it a worthy opponent, the Koschei's Active Stealth puts this destroyer in her own class. Lastly, the ship features the capacity to deploy a troop or boarding compliment as needed.

AC	Ship HPs	Hull HPs	Shields
15	450	22	60
Proficiency	Advanced		
Acceleration	4.5 meters		
Horizon Drive	0.3ly/h		
Crew	12		
Passengers	10		
Size	L 240m H 24m W 96m		
Credit	+95 Uncommon		
Systems			
Helm 1	Advanced Sensors, Array 1		
Helm 1	Active Stealth		
Helm 2	Advanced Sensors, Array 2		
Comms	Tactical Communication		
Comms	Astral Node		
Engineering	Antimatter Fusion Reactors		
Engineering	KZM Shields		
Engineering	Damage Control Drones		
Tactical 1	Weapons Array 1		
Tactical 1	Combat Computer		
Tactical 2	Weapons Array 1		
Tactical 2	Combat Computer		
Cargo Bay	60 tons, pressurized		

Features

Active Stealth. Optical camouflage combined with radar, electromagnetic, and thermal dampening. While active, this system doubles the pilot's Piloting check bonus for stealth.

Light Armor. The Koschei is well armored and has a Damage Threshold of 5.

Medical Bay. This is a complete medical facility with two beds.

Engineering Bay. This is a complete fabrication facility.

Weapons Array 1

Medium Autocannon Turret, 4-Tube Small Missile pod turret

Weapons Array 2

Medium Autocannon Turret, 4-Tube Small Missile pod turret

Magisterium Urduj Gunship

The heavily armed Urduj class gunship is designed to deal the damage. Armed to the teeth, the Urduj were deployed as fire support for carriers and fighters, or for planetary strikes.

AC	Ship HPs	Hull HPs	Shields
15	450	22	60
Proficiency	Advanced		
Acceleration	7 meters		
Horizon Drive	0.3ly/h		
Crew	14		
Passengers	6		
Size	L 200m H 44m W 56m		
Credit	+75 Uncommon		
Systems			
Helm 1	Tactical Sensors, Array 1		
Helm 2	Tactical Sensors, Array 2		
Comms	Tactical Communication		
Comms	Astral Node		
Engineering	Antimatter Fusion Reactors		
Engineering	KZM Shields		
Engineering	Damage Control Drones		
Tactical 1	Weapons Array 1		
Tactical 1	Combat Computer		
Tactical 2	Weapons Array 2		
Tactical 2	Combat Computer		
Tactical 3	Weapons Array 3		
Tactical 3	Combat Computer		

Features

Astral Node. The ship is equipped with a full AstralNet node. This allows the ship's computers and paired devices to access the AstralNet via the ship's node.

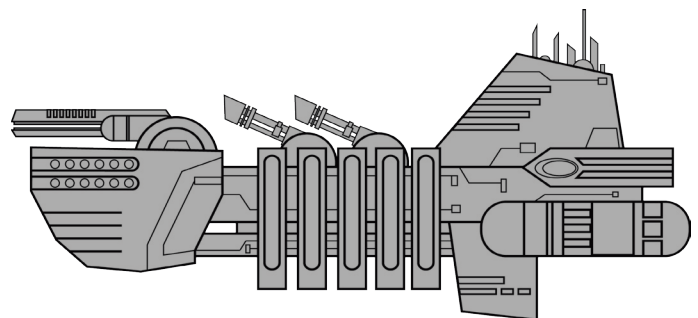

Advanced Computer Package. All computers on the ship are networked and any one station can be accessed from another apart from executive functions.

Light Armor. The Magisterium Urduj is designed to take significant damage and has a Damage Threshold of 5.

Medical Bay. This is a complete medical facility with two beds.

Engineering Bay. This is a complete fabrication facility.

Weapons Array 1

Particle Accelerator Turret (2 accelerators)

Weapons Array 2

Heavy HI Laser Turret, 4-Tube Small Missile pod turrets (2)

Weapons Array 2

Heavy HI Laser Turret, 4-Tube Small Missile pod turrets (2)

Heavy Spacecraft

Most cruisers and carriers fall into this category, Heavy ships are small interstellar communities with

Corporate Zheng He Force Explorer

The force explorer Zheng He represents the cumulative effort of a dozen corporations sharing technology and man power to build a carrier.

AC	Ship HPs	Hull HPs	Shields
16	1,250	29	120
Proficiency	Advanced		
Acceleration	3 meters		
Horizon Drive	0.3ly/h		
Crew	56		
Passengers	2600		
Size	L 1200m H 200m W 320m		
Credit	+190 Restricted		
Systems			
Helm 1	Tactical Sensors, Array 1		
Helm 2	Tactical Sensors, Array 2		
Comms	Tactical Communication		
Comms	Astral Node		
Science	Advanced Sensors		
Engineering	Antimatter Fusion Reactors		
Engineering	KZM Shields		

Engineering 2	Damage Control Drones
Tactical 1	Weapons Array 1
Tactical 1	Combat Computer
Tactical 2	Weapons Array 2
Tactical 2	Combat Computer
Tactical 3	Weapons Array 3
Tactical 3	Combat Computer
Fighter Bay	250 Fighters
Cargo	2000 tons

Features

Astral Node. The ship is equipped with a full AstralNet node. This allows the ship's computers and paired devices to access the AstralNet via the ship's node.

Advanced Computer Package. All computers on the ship are networked and any one station can be accessed from another apart from executive functions.

Medium Armor. The Ship has significant armor and has a Damage Threshold of 5.

Medical Bay. This is a complete medical facility with twenty beds.

Engineering Bay. This is a complete fabrication facility.

Science Bay. This is a complete laboratory.

Heavy Point Defense Cannons

Weapons Array 1

Tactical Railgun Turret

Weapons Array 2

Stern 4-tube Medium missile pod x5

Aft 4-tube Medium missile pod x5

Weapons Array 3

Heavy Autocannon Turrets x 10

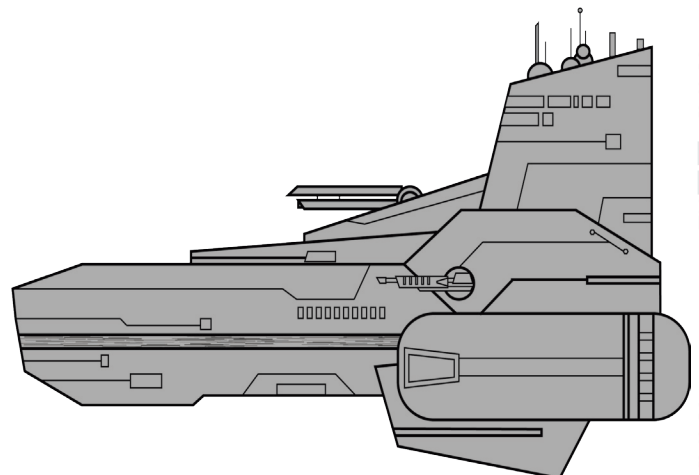

Capitol Ships

These interstellar cities are practically mobile space stations. Capitol ships are rare even in the arc, as the cost to construct these behemoths and man them is exorbitant.

Magisterium Tihamath Dreadnought

When the Magisterium needs to send a message, a dreadnought is dispatched. Several kilometers long and bristling with guns, the Tihamath class ship is known as a world ender.

AC	Ship HPs	Hull HPs	Shields
20	2,000	80	300
Proficiency	Capitol		
Acceleration	2.5 meters		
Horizon Drive	0.3ly/h		
Crew	200		
Passengers	10200		
Size	L 4400m H 980m W 650m		
Credit	+475 Restricted		
Systems			
Helm 1			
Helm 2			
Comms	Tactical Communication		
Comms	Astral Node		
Science 1	Tactical Sensors		
Science 2	Advanced Sensors		
Engineering	Antimatter Fusion Reactors		
Engineering	Damage Control Drones		
Engineering 2	KZM Shields		
Engineering 2	Back-up Reactors		
Tactical 1	Weapons Array 1		
Tactical 1	Combat Computer		
Tactical 2	Weapons Array 2		
Tactical 2	Combat Computer		
Tactical 3	Weapons Array 3		
Tactical 3	Combat Computer		
Fighter Bay	400 Fighters		
Cargo	500,000 tons		

Features

Astral Node. The ship is equipped with a full

AstralNet node. This allows the ship's computers and paired devices to access the AstralNet via the ship's node.

Advanced Computer Package. All computers on the ship are networked and any one station can be accessed from another apart from executive functions.

Shipboard Intelligence

Heavy Armor. The Ship has significant armor and has a Damage Threshold of 25.

Medical Bay. This is a complete medical facility with one hundred beds.

Engineering Bay. This is a complete fabrication facility.

Science Bay. This is a complete laboratory.

Heavy Point Defense Cannons

Weapons Array 1

Dual Graviphoton Beam Cannons

Heavy Graviphoton Grapple

Weapons Array 2

Heavy Particle Accelerator Turrets x 20

Weapons Array 3

4-Tube Medium Missile pods x10

MIRV Medium Missile tubes x 10

Ship Weapons

Ship weapons are categorized by the minimum class of ship to which they can be equipped, light, medium, heavy or capitol.

Ammunition. Energy weapons generally do not require ammunition as they are connected directly to the ship's power supply. Mass drivers however require ammunition to fire.

Armor Piercing. Most ship scale mass drivers have the armor piercing property. These weapons will ignore a set amount of toughness listed in parenthesis. For instance, an armor piercing round with an AP (10) would ignore ten points of ship toughness on a successful attack.

Burst. This ranged weapon is capable of automatic fire, releasing a burst of rounds. The damage for the burst, and the number for rounds will be listed in parenthesis, separated by a slash. Against large or smaller targets, a ship sized weapon with the burst property has the Threat property, at full damage.

Explosive. Missiles deal damage in an area of effect. All ships and parts in the area of effect take full damage unless their pilot succeed a Dexterity saving throw DC 8 + your dexterity modifier, for half damage. If you are Proficient in Weapon Systems add your proficiency bonus to the save DC. The number in parenthesis is the area of the explosion.

Ship Weapons

Ship Weapon	Damage	Mass	Credit Mod	Range	Properties
Energy Weapons					
Light PDC Lasers	3d10 thermal	20kg	+8 uncommon	100m/300m	
Heavy PDC Lasers	5d10 thermal	80kg	+10 uncommon	150m/500m	
Light HI Laser Cannon	10d10 thermal	250kg	+10 uncommon	1000m/4km	Burst (15d10)
Heavy HI Laser Cannon	20d10 thermal	550kg	+14 rare	3km/9km	
Particle Accelerator	10d12 radiation	800kg	+16 restricted	2km/6km	+5d12 thermal, AP (10)
Heavy Accelerator	15d12 radiation	1.5 tons	+18 restricted	2.5km/7.5km	+10d12 thermal, AP (15)
Graviphoton Beam	20d10 force	750kg	+16 restricted	5km/15km	+10d10 thermal
Graviphoton Cannon	20d10 force	825kg	+18 restricted	4km/12km	+10d10 thermal, burst (30d10)
Light Grapple	-	300kg	+6 common	30m	
Medium Grapple	-	500kg	+8 common	300m	
Heavy Grapple	-	850kg	+10 uncommon	3000m	
Mass Drivers					
Light Autocannon	10d12 impact	60kg	+8 uncommon	300m/900m	Burst (20/15d12), AP (10)
Medium Autocannon	20d12 impact	215kg	+11 uncommon	500m/1km	Burst (20/30d12), AP (15)
Heavy Autocannon	30d12 impact	550kg	+14 rare	2km/6km	Burst (20/50d12), AP (20)
Ballistic Railgun	20d8 impact	5 tons	+18 restricted	10km/30km	AP (30)
Tactical Railgun	50d8 impact	21 tons	+22 restricted	100km/300km	AP (50)
Missile Launchers					
Chaff Launcher	-	120kg	+2 uncommon	-	
Missile mount	-	15kg	+6 uncommon	-	
4-tube Small Missile Pod	-	65kg	+8 rare	-	
4-tube Medium Pod	-	250kg	+8 restricted	-	
MIRV Missile tube	-	950kg	+16 restricted	-	
Missiles					
Chaff Canaster	1d10 impact	8kg	+2 restricted	200m/600m	Special
Small Interceptor	10d6 bludgeoning	25kg	+4 restricted	400km/1000km	+5d10 thermal, explosive (10m)
Small Flack	15d8 impact	55kg	+4 restricted	400km/1000km	+5d10 thermal, explosive (30m)
Small Plasma	20d10 thermal	40kg	+6 restricted	400km/1000km	+5d8 impact, explosive (15m)
Medium Interceptor	20d6 bludgeoning	700kg	+8 restricted	1000km/3000km	+5d10 thermal, explosive (300m)
Medium Flack	30d8 impact	875kg	+10 restricted	1000km/3000km	+10d10 thermal, explosive (600m)
Medium Plasma	30d10 thermal	800kg	+12 restricted	1000km/3000km	+10d8 impact, explosive (400m)
Medium Thermonuclear	50d10 thermal	1200kg	+22 restricted	1500km/4500km	+20d8 impact, explosive (1000m)
Medium Fusion	100d10 thermal	1500kg	+45 restricted	1500km/4500km	+50d6 radiation, explosive (3000m)

Range. The range lists two numbers. The first is the weapon's normal range in kilometers, and the second indicates the weapon's long range. When attacking a target beyond normal range, you have disadvantage on the attack roll. You can't attack a target beyond the weapon's long range.

Energy Weapons

In space, energy weapons are more efficient and less risky than projectiles. Most energy weapons do consume an amount of chemical fuel, but these can last years, and draw directly on the ship's primary reactor.

Point Defense Cannon

A battery of light lasers that automatically track and attack nearby objects. Designed to intercept missiles and light projectiles as well as extremely close ship combat. Point Defense Cannons are automated and will attack any object that provokes and opportunity attack. Point Defense Cannons do not require a tactical station.

HI Laser Battery

One of the most common forms of space offence are the HI Laser cannons. While colloquially called High Intensity Lasers, the HI refers to the Helium-3 Iodine-129 excitation medium of the laser.

Particle Accelerator

A particle beam weapon is multi-part, with a coherent maser beam acting as a medium for a burst of free neutrons accelerated to the speed of light, imparting gigajoules of kinetic energy.

Graviphoton Beam

Weaponized graviphoton beams function much like laser, but the result is a beam of gravitational energy that can cause micro fission and fusion as it implodes molecules in a tiny area a few nanometers across.

Graviphoton Grapple

Much like the system used to generate gravity in ships and stations, a graviphoton grapple resembles the concepts of tractor beams; a pulse graviphotons can attract an object. A person targeted can attempt to dodge a beam with a Dexterity saving throw with a DC set by the

Technical Operations roll of the beam operator, or 15 if it is automated.

Small Grapple. Can pull up to 1 ton at a range of 30 meters.

Medium Grapple. Can pull up to 100 tons at a range of 300 meters. A Dexterity (piloting) check DC 15 is required to break free in a ship.

Heavy Grapple. Can pull up to 10,000 tons at a range of 3km. A Dexterity (piloting) check DC 20 is required to break free in a ship.

Mass Drivers

The most dangerous weapons in space remain mass drivers, yet they come with significant risk. Jammed or misfiring weapons can cause serious damage, and recoil dampening requires significant energy.

Autocannon

A type of recoil compensated vacuum safe machinegun that is incredibly common. To prevent heat buildup most use gas compression rather than a chemical accelerant to fire projectiles.

Railgun

This mass driver uses powerful electromagnets and graviphoton emitters to accelerate a projectile to relativistic speeds. The impact is in the order of petajoules however they require powerful thrusters to counter and stabilize.

Missiles

Self-propelled and self-guided explosives, missiles are the heart of the aerospace combat. Launchers are listed separately from missiles. The price listed for missiles is the cost of the individual munition, and the size is the type of missile bays or tubes needed to fire that missile.

Acceleration. Missiles have ranges so high that it may take several rounds to reach their target, and canny pilots may attempt to dodge in this time. A Small missile's acceleration is 70 meters, and a Medium missile's is 140 meters. Small Missiles maintain acceleration for 2 minutes, and Medium missiles maintain acceleration for 6 minutes.

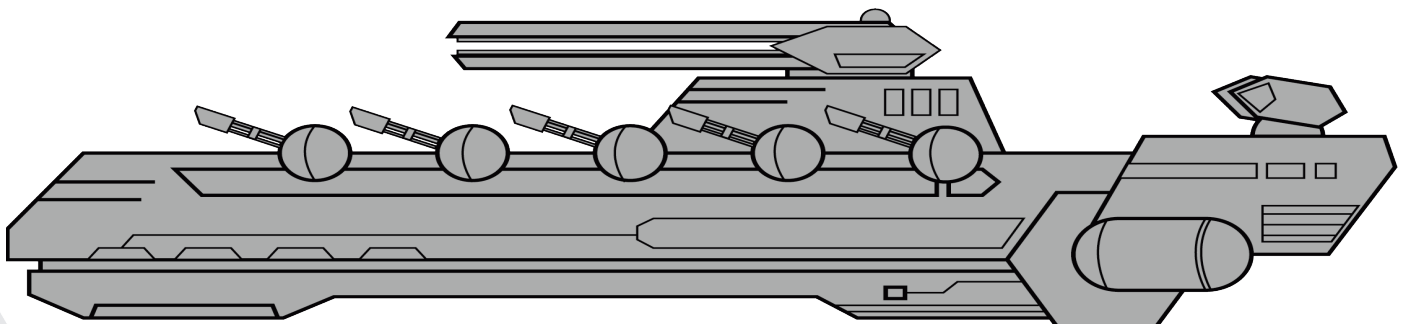

Chaff

This missile releases a cloud of magnetic particulates that can confuse sensors, scatter energy weapons, and disable missile locks. Chaff will give the defender three-quarters cover and resistance to energy weapon damage for 4 rounds or until their vector provides attackers with a clear line of sight. A chaff cloud can be dispersed with a direct attack from a missile or similar area weapon.

Systems

Astral Node

The ship is equipped with a full AstralNet node. This allows the ship's computers and paired devices to access the AstralNet via the ship's node.

Atmospheric

With this system the ship is equipped with thrusters capable of atmospheric thrust and heatshields that allows for atmospheric entry at some speed.

Communications Package, Primary

This is the common communications systems for space craft include a powerful multi-frequency radio with tight beam capability. A successful Intelligence (computers) check can encrypt outgoing communications.

Communications Package, Tactical

Designed for combat theaters, this communications system is capable of jamming nearby communications with a successful Computers (jamming) check. Attempts to overcome jamming with this system are made with a +1 bonus. By default, this system encrypts outgoing communication.

Computer Package, Advanced

With an advanced computer system all computers on the ship are networked and any one station can be accessed from another apart from executive functions. This requires a DC 15 Intelligence (computers) check, or a DC 10 Technical operations check.

Computer Package, Combat

A sophisticated combat computer is built into one of the tactical stations. This can either automatically target and attack on the commander

or pilot's turn with that tactical station's weapons. The combat computer has a proficiency attack bonus of +2 and may fire one weapon on its turn. It cannot take bonus or reactions.

Optionally the computer can track and identify targets for the operator, providing Advantage on a user's Weapons Systems attack rolls from that tactical station.

Computer Package, Shipboard Intelligence

A shipboard intelligence is a thinker integrated into an advanced computer system (as above). Further because the AI can operate many of the ship's systems it can operate at full efficacy with a skeleton crew.

The ship's thinker is equipped with proficiency in Computers, Technical Operations, Sciences, and Weapon Systems.

Damage Control Drones

As many as 10 remote-control damage control drones can be controlled via an engineering terminal. Once released each can be directed to perform emergency repairs, fire suppression, and damage assessment. See, drones in the equipment section.

Sensor Package, Exploration

Designed for scientific inquiry and discovery, this system includes lidar, radar, a/v, spectrographic, and electromagnetic sensors. On your turn, you may use your action to gather any one of the following pieces of information about your environment with a DC 15 Intelligence (computers) or DC 10 Computers (Technical Operations) check.

- Display the environment in high resolution, infrared, and ultraviolet with x10000 magnification.
- Mass, number and vector of objects in the local space, including ships, planets, asteroids and chafe or debris.
- Analysis of the atmosphere and meteorological conditions of a planet.
- Number and estimates out-put of energy sources or energy fields.
- Analysis of the chemical composition of the surface of an object within 30,000km.
- Map the topology and shape of a surface within 30,000km up to 1000km squared.

Sensor Package, Simple

This basic array of sensors includes radar, audio-visual systems, and basic electromagnetic sensors. On your turn, you may use your action

SPACESHIPS

to gather any one of the following pieces of information about your environment with a DC 15 Intelligence (computers) or DC 10 Computers (Technical Operations) check.

- Display the environment in high resolution, infrared, and ultraviolet with x100 magnification.
- Number, mass, and vector of all local objects, including ships, planets, asteroids and chafe or debris.
- Analysis of the atmosphere and meteorological conditions of a planet.

Sensor Package, Sophisticated

An advanced all-purpose sensor array which includes lidar, mass detection, a/v, electromagnetic and thermal imaging. On your turn, you may use your action to gather any one of the following pieces of information about your environment with a DC 15 Intelligence (computers) or DC 10 Computers (Technical Operations) check.

- Display the environment in high resolution, infrared, and ultraviolet with x10000 magnification.
- Mass, number and vector of objects in the local space, including ships, planets, asteroids and chafe or debris.
- Analysis of the atmosphere and meteorological conditions of a planet.
- Number and estimated out-put of energy sources or energy fields.

Sensor Package, Tactical

Identical to sophisticated sensors, but outfitted with specialized tactical gear, such as friend or foe detection and weapons detection. These sensors will provide the crew with an initiative bonus of +2.

Stealth, Active

Optical camouflage combined with radar, electromagnetic, and thermal dampening. While active, this system doubles the pilot's Piloting check bonus for stealth.

Stealth, Passive

The exterior of the ship is equipped with systems designed to minimize its lidar and radar cross-section. The pilot has Advantage on stealth piloting checks.

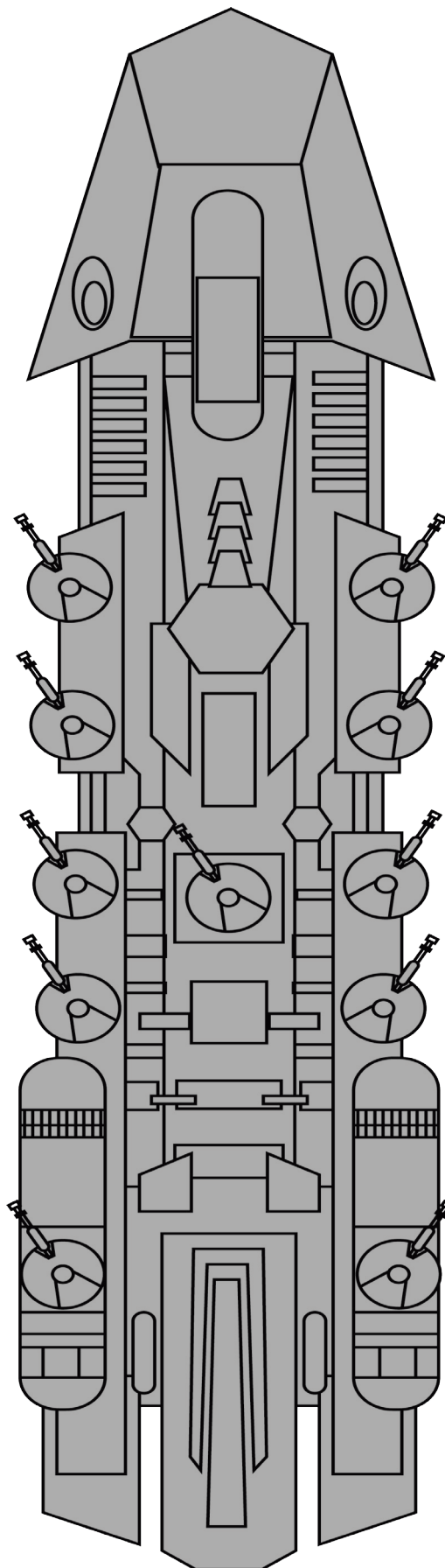

SECTION II AUGMENTATION

When push comes to shove, the dangers of the arc have forced various civilization to explore various methods of augmentation and enhancement. Adventurers have taken advantage of these technologies to give them the extra edge as they explore and confront the dangers of space.

CYBERNETICS

In the past, robotic prosthetics gave those unfortunate enough to have lost a limb or organ a chance to survive and feel whole again. As the technology matured, bioengineering became so advanced that 3D printed limbs and organs cloned from the host's cells could be created to replace crude prosthetics.

The advent of nanotechnology propelled cybernetics into an avenue of augmentation. Stem cells which contained nanomachines allowed for powerful biomechanical upgrades. Limbs with built in weapons, computers and sensors integrated into the brain, and fundamental changes to the cardio vascular, skeletal, and nervous system are possible.

Unlike Genetic Modification which is unpredictable in mature organisms, cybernetics can be manufactured and attached to a creature to quickly enhance its' abilities.

Cybernetic Affinity [Feat]

You may select this feat with a proficiency slot if you have at least 1 cybernetic implant or augmentation. When you take this feat, your Cyber Tolerance increases by 2. With the GM's Permission you may select this feat up to 3 times, increasing your tolerance by 6 total.

Getting Cybernetics

Most cybernetics are Cyber Mods, biomechanical upgrades made with a mixture of sophisticated electromechanical systems, nanomachines, and host tissue. This limits host rejection and allows for high levels of augmentation, but in means more than half of the cyber mod is custom grown for the intended host. While most cybernetics are simple and intuitive to use, advanced application requires some training.

Installation

Getting a cyber mod installed requires that the core be prepared for the specific host, when usually requires a number of hours to grow the necessary attachments, and a successful Medicine (surgeon) check against a DC of 20. A failed roll means the patient rejects the implant and is reduced to 0 hit points and is dying. Removing an attachment carries the same check and risks.

Cyber Tolerance

A creature has a limited capacity for cybernetic modification, this manifests as a cyber tolerance. You cyber tolerance is the number of cybernetic implants your body can sustain without serious risk of complication. Each Cyber Mod requires an amount of cyber tolerance depending on the stress it puts on your body.

You have 2 + you Constitution modifier cyber tolerance slots. Each slot you fill beyond your cyber tolerance causes cyber syndrome, reducing your ability to heal naturally and causing other problems for you.

Cyber Syndrome

When a creature receives more cybernetic modifications than they can sustain, their body begins to malfunction. For each point of cyber mods you have installed beyond your max tolerance, you are considered to have spent 1 of your hit dice, as if recovering during a short rest. You cannot recover this hit dice through long rests or healing.

When it comes time to heal, a creature suffering from any degree of cyber syndrome can only recover half as many hit points from rest or technological healing, unless the healer can make a DC 15 Intelligence (medicine) or Med Kit check.

Prolonged Cyber Syndrome often results in Antipathy and mental illness.

Cyber Mods

The available cyber mods are broken into two categories: upgrades and enhancements. Upgrades take the place of a limb or organ and provide a significant improvement, enhancements add completely new functionality and abilities such as additional senses or weapons.

Cyber mods are almost all powered by the host - bloodflow and chemical energy are extracted from the biomechanical interface to provide the electrical energy required in most cases. Some, like weapons, require energy clips or battery packs to operate, however.

Bio Replacements

Uncommon

Standard 3D printed biologically cloned limbs and organs are not cyber mods, and do not use up cyber tolerance. These are not an augmentation, simply an exact replica of the tissue in a perfect healthy state. Following attachment a bio replacement for a destroyed limb or organ requires 1d4 days of rest before the limb or organ is operating normally.

Bio Replacement	Credit mod
Arm or hand	+6
Leg or foot	+7
Sensory organ	+9
Vital organ	+9

While Bio Replacements do not have a tolerance cost associated with them, replacing multiple limbs or organs can cause rejection syndrom even in healthy patients.



Cybernetic Arm

Uncommon, Credit mod +7

Basic Cybernetic arms replicate the function and strength of the original limbs, including sensory ability, but are much harder and more resilient than strictly biological limbs and can support integrated weapons without costing additional cyber tolerance. A cybernetic arm has Resistance to slashing, piercing, and bludgeoning damage, and each provides a +1 bonus to AC. Two cybernetic arms will provide advantage on climbing checks.

Tolerance Cost: 2

Advanced Cybernetic Arm

Uncommon, Credit mod +9

These sophisticated limbs are just as durable as basic limbs and provide the same bonuses, however the tolerance cost is reduced.

Tolerance Cost: 1

Cybernetic Leg

Uncommon, Credit mod +8

Standard issues cybernetic legs are swift and durable. Each leg has Resistance to slashing, piercing, and bludgeoning damage, and each provides a +1 bonus to AC. Each Cybernetic leg reduces the tolerance cost of a Speed upgrade by 1 and can support integrated weapons holsters with no tolerance cost.

Tolerance Cost: 2

Advanced Cybernetic Leg

Uncommon, Credit mod +10

As with the advanced arms the major advantage of this system is its reduced tolerance cost, it is otherwise identical to a Cybernetic Leg.

Tolerance Cost: 1

Multi-Arm Upgrade

Rare, Credit mod +12

Two additional cybernetic arms are attached to a creature that normally only has two, either over the shoulder or under the existing arms. These are basic cybernetic arms. Having four arms provides you Advantage on Grapple checks, and Advantage on Climbing checks.

Tolerance Cost: 5

Cybernetic Tail

Uncommon, Credit mod +6

This 2-meter prehensile extension of the spine can be used as a prehensile grip, or whip a target in reach as a standard action for 1d6 damage on a successful hit. A cybernetic tail aids with balance and give you advantage on Acrobatics checks.

Tolerance Cost: 2

Cybernetic Eye

Uncommon, Credit mod +6

This sophisticated ocular upgrade has several features. The built-in display can overlay neural computer data if one is installed, or it can simply provide basic information. The eye has limited Darkvision, to a range of 5 meters, and can magnify and zoom to a factor of x10. Using magnification can give you advantage of Investigation and science checks where needed and using the zoom feature can give you advantage on perception checks to see and identify distant objects.

Tolerance Cost: 1



Advanced Cybernetic Eye

Uncommon, Credit mod +7

A far more advanced version of the cybernetic eye, this model can see much better in darkness, with Darkvision out to 30 meters. It can also see infrared and heat signatures giving you advantage to spot stealthy or hidden creatures. In addition to the magnification and zoom of the basic version.

Tolerance Cost: 2

Cybernetic Ears

Uncommon, Credit mod +4

Both ears are replaced with mechanisms that can detect far more delicate sounds and an increased frequency. This augmented hearing provides advantage on Wisdom (perception) checks that involve hearing.

Tolerance Cost: 1

Cybernetic Strength Augment

Uncommon, Credit mod +8

These implants will augment your physical power, increasing your Strength Score by 2. The augments are woven into the muscle and cinque and attached to the bones, which limits how much a person can be augmented. Multiple implants will increase your Strength score to a maximum of +6 with three implants. Each cybernetic limb such as an arm or a leg, reduces the tolerance cost of strength augmentation by 1. For example, if a character with two cybernetic legs were to receive this implant, the tolerance cost would only be 2.

Tolerance Cost: 4

Cybernetic Dexterity Augment

Rare, Credit mod +7

These cybernetic implants can increase your agility and grace, increasing your Dexterity Score by 2. You can receive up to three of these implants, for a maximum bonus of +6. Each cybernetic limb such as an arm or a leg, reduces the tolerance cost of strength augmentation by 1. For example, if a character with two cybernetic arms were to receive this implant, the tolerance cost would only be 2.

Tolerance Cost: 4

Cybernetic Speed Augment

Rare, Credit mod +5

A combination of speed and strength augments in the lower body increase movement speed by 10 meters, and doubles the distance you can jump.

Tolerance Cost: 3

Subdermal Armor

Uncommon, Credit mod +6

A flexible weave of carbon-nanomesh, non-Newtonian gel, and impact sensors are implanted under the skin. This provides you a +1 bonus to armor class. Subdermal Armor cannot be combined with dermal armor or cyber armor.

Tolerance Cost: 1

Dermal Armor

Rare, Credit mod +9

Large sections of the epidermis are replaced with natural looking synthetic skin designed to protect and absorb damage. This gives you with a natural armor class of 13 + Dexterity modifier while you are unarmored. While you are wearing armor, you have a +1 bonus to armor class. Dermal Armor cannot be combined with subdermal armor or cyber armor.

Tolerance Cost: 2

Dermal Camouflage

Rare, Credit mod +10

The epidermis is replaced, and the outer area of cyber limbs is covered with an organic light transferal optical camouflage. While you are holding still you are practically invisible, and your passive Stealth check is doubled. While moving you have Advantage on Dexterity (stealth) checks and you double your proficiency bonus (if you are proficient) on all stealth rolls. Dermal Camouflage cannot be combined with cyber armor.

Tolerance Cost: 3

Light Cyber Armor

Rare, Credit mod +9

Flexible plates of biometals and carbon nano-weaves are attached to the body to offer significant protection. You have a natural armor class of 15 + Dexterity modifier while you are not wearing additional armor. You have a natural armor rank modifier of +2. Light Cyber Armor falls under light armor proficiency. Each cybernetic limb you possess, such as an arm or leg, reduces the tolerance cost of Light cyber armor by 1, to a minimum of 0.

Tolerance Cost: 3

Heavy Cyber Armor

Restricted (Government), Credit mod +14

For all intent and purpose, a light suit of power armor is grafted on to you. Advanced polymers and bimetals fused over your body, mechanisms to move and bend the interlocking plates, and nanomachines to maintain the system. Heavy

Cyber armor provides you with an armor class of 18 + Dexterity Modifier, has an Armor rank modifier of +5, and falls under Tactical Armor proficiency. Each cybernetic limb you possess, such as an arm or leg, reduces the tolerance cost of heavy cyber armor by 1. If you possess four cybernetic limbs, and heavy Cyber armor, you gain Resistance to slashing, piercing, and bludgeoning damage.

Tolerance Cost: 6

Bone Weave

Rare, Credit mod +8

Your natural bones are surrounded with a rigid weave of carbon-nanomesh and structs of biometal. Your bones are practically unbreakable, and you have resistance to falling damage. This mod cannot be combined with Biometal Skeletal Framework.

Tolerance Cost: 1

Biometal Skeletal Framework

Restricted (Government), Credit mod +10

Your bones are fused with advanced biometals grown on to implanted nodes over the course of weeks. Your cartilage is replaced with high impact gels. Your nearly indestructible skeleton increases your instant death threshold is increased by 10 hit points. You gain a onetime bonus of +1 to your Strength score as you can push yourself much farther without risking injury. You have resistance to falling damage.

Tolerance Cost: 2

Neural Computer

Common, Credit mod +4

An advanced computer system is integrated into your brain. This device can perform any of the functions of a power 4 computer with no properties, and no wireless networking (see section 7), as well as record images and video from cybernetic sensors installed such as eyes and ears, project data to an eye implant, and provide storage and access to information.

Tolerance Cost: 1

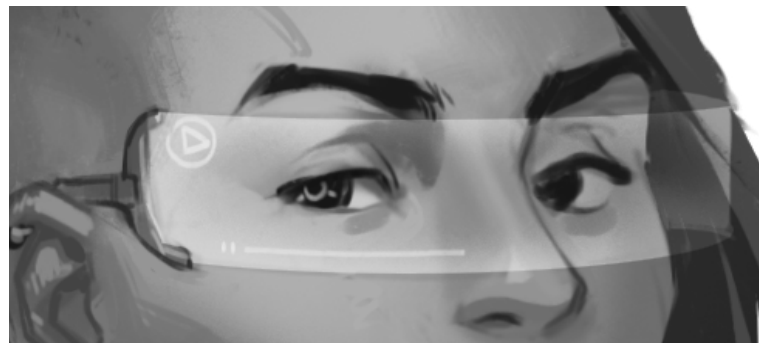

Wireless Implant

Common, Credit mod +2

Requires a Neural Computer. This is a multi-band wireless transceiver that allows for radio communication, as well as pairing your neural computer with other computerized devices, weapons, and armor. This add the Comms and Ident properties to your neural computer. As a communicator the broadcast range is 10km, enough to connect to most local communications networks or ship or station board coms nets.

Tolerance Cost: 1

Universal Computer Jack

Common, Credit mod +2

Requires a Neural Computer. This allows your neural computer a direct wired connection to an external computer interface. While faster and more secure than wireless, security counter measures designed to damage intrusive hardware could potentially cause you real damage. However, this will provide you Advantage on Hacking checks.

Tolerance Cost: 1

Skillsoft Computer Implant

Common, Credit mod +2

Requires a Neural Computer. A program designed to mimic proficiency in a skill, this miniature artificial intelligence will allow you to perform one tool proficiency with a proficiency bonus of +3. You do not gain proficiency in the tool.

Tolerance Cost: 0

Astral Access Implant

Rare, Credit mod +8

Requires a Neural Computer. Your Neural Computer is an Astral Access node.

Tolerance Cost: 1

Wired Reaction Implant

Rare, Credit mod +4

Requires Neural Computer Implant, cybernetic eye implant. This implant bypasses normal visual reaction systems to force you to react faster. This Implant grants a +2 bonus of Initiative checks.

Tolerance Cost: 1

Lung Air Filter

Uncommon, Credit mod +4

Built into a biomechanical lung replacement this device will filter out dangerous gasses from the raspatory system, such as smoke, poison gas, and some weak nerve agents. You have advantage

to save against gas attacks. If you would suffer half damage from a gas attack on a successful save, you instead take no damage.

Tolerance Cost: 2

Bio Toxin Filter

Uncommon, Credit mod +6

A device designed to identify and filter dangerous chemicals in the blood stream. This implant provides you Resistance to Poison damage.

Tolerance Cost: 1

Neural Insulation

Rare, Credit mod +8

Nerves and the spinal cord are wrapped in a gentle flexible insulating gel weave. This implant greatly reduces the effects of electrical shocks to the system. You are immune to the stun effect of most stun guns, and have Resistance to electrical damage.

Tolerance Cost: 2

Vocal Modulator

Uncommon, Credit Mod +2

This enhanced vocal cord and modulate and mimic a wide range of sounds and calls, and if attached to a Neural Computer can even play back recorded voices near perfectly.

Tolerance Cost: 1

Programable Positional Compass

Common, Credit mod +2

An implant that functions like a programable gyroscopic compass. With this device it is virtually impossible to get lost or lose your bearings. You have advantage on all navigation related checks. With a neural computer you can store and review past positional information and calculate routes.

Tolerance Cost: 1

Fusion Power Core

Restricted (corp, government), Credit mod +18

You have a nuclear power plant miniaturized and seated in your abdominal cavity. This power supply can power integrated energy weapons, as well as ease the tolerance requirements of energy hungry implants. You can power up to four integrated weapons, and the tolerance cost of Multi Arm Augment, Strength Augment, Dexterity Augment, Heavy Cyborg Armor, and all Neural Computer implants is reduced by 1.

Tolerance Cost: 4

External Weapon

Uncommon

A weapon is attached to an external mount. It is clearly visible as a weapon. Powered weapons and energy weapons still require an external power source, and mounted firearms require ammunition. Weapons mounted to a cybernetic limb have a tolerance cost of 0. By replacing the hand, an external weapon will have a Credit mod that is 1 less (minimum of 1).

The Credit modifier for an external weapon is the same as the weapon's normal Credit modifier. Externally mounted weapons may have weapons mods installed on them.

Tolerance Cost: 1

Integrated Weapon

Rare

A weapon is built into an arm or leg. The weapon is retractable and hidden until in use. Powered weapons and energy weapons still require an external power source, and firearms require ammunition. Weapons built into a cybernetic limb have a tolerance cost of 0. By replacing the hand, an external weapon will have a Credit mod that is 2 less (minimum of 1).

The Credit modifier for integrated weapons is 1 higher for melee weapons such as blades. Integrated powered melee weapons, integrated firearms, and integrated energy weapons have a Credit modifier increased by +2.

Tolerance Cost: 2

Psionic Amplifier Implant

Restricted (corp, government), Credit mod +34

The absolute cutting edge of neural enhancement, this upgrade is designed to unlock or augment psionic ability. A network of nanites and cultured neurons are surgically implanted into the brain, unlocking proficiency in one of the psionic skills, or augmenting one if proficiency already exists. Roll 1d4 to determine what psionic proficiency is unlocked. If you already have this proficiency, you have advantage on this psionic skill.

d4	Psionic Proficiency
1	Telepathy
2	Biomanipulation
3	Telepresence
4	Telekinesis

Tolerance Cost: 2

PSIONICS

Silence reigns aboard the bridge of the ship, even the Admiral, a terse man prone to short bursts of bellowing command is still as the void. The young lady at the center of the raised platform that emits the holodisplay hold the attention of all. Her eyes closed, brow furrowed in intense concentration. After a bare moment of the raw silence her eyes snap open and her arm shoots out, pointing at a tiny dot projected on the holosphere.

Extraordinary mental abilities are a common theme throughout science fiction, and Advent Horizon is no different. Since venturing into the expanse, the peoples of the arc have found that a select few may begin to exhibit abilities that stretch credulity. This power is known as Psionics.

Developing Psionics

You may spend one of your proficiency slots to gain one of the psionic core skills such as telepathy or psychokinesis. Some races are naturally psionic, and automatically have proficiency in one of these preternatural core skills.

Psionic specialties are known as talents and require a great deal of training and effort to develop. Each talent costs 2 proficiency slots to learn for normal characters.

Understanding Psionics

Proficiency in one of the psionic skills, such as Biomanipulation or Telepathy, allows you to use a basic psionic ability and opens a psionic skill tree so that you may select psionic specialties, known as Talents.

Psionic skills are ability checks, but you cannot attempt to use a psionic skill if you are not proficient. Proficiency in a psionic skill does not automatically grant you any psionic talents.

Each talent is a discreet psionic ability with a unique effect. Each talent is tied to an ability score based on its parent ability score. You use this ability score modifier when setting the saving throw DC for a psionic ability or when making an attack roll with one.

Talent save DC = 8 + your proficiency bonus + your ability modifier

Talent attack modifier = your proficiency bonus + your ability modifier

Psionic Skills

Bio-manipulation [Constitution]

Sometimes called biokineseis, this ability allows you to manipulate living organisms. Bio-manipulation talents can resist damage, slow aging, and some claim it may be possible modify the very building blocks of life. With a Constitution (bio-manipulation) check you can repair or cause damage to an organism composed of biological material. Used as an attack you must make a melee attack against the target using your Constitution. If you hit, the target suffers 1d6 psychic damage. Used to heal, you must lay hands on the target and make a DC15 Constitution (bio-manipulation) check. If you succeed a dying subject that has 0 hit points stabilizes, stable creatures recover 1d4 hit points.

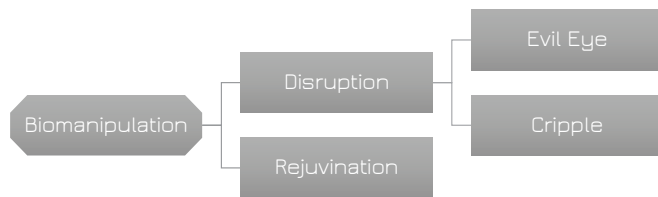

Disruption

As a standard action you can release a psionic pulse at a creature you can see within 10 meters. The target must succeed an intelligence saving throw or suffer 1d8 psychic damage and be paralyzed until the end of your next turn. Inanimate objects and machines are immune to this effect. The base damage of Disruption increases by an additional 1d8 when you reach 5th (2d8), 11th level (3d8), and 17th level (4d8).

Evil Eye

With a cruel gaze you may use your action to plague a biological target you can see within 10 meters. The target must make a Constitution saving throw or suffer one of the following afflictions of your choice:

- 1d8 poison damage
- 1d8 corrosive damage
- Disadvantage on Constitution saving throws until the end of your next turn
- Stun the creature until the end of your next turn

Afflictions that deal damage increases by an additional 1d8 when you reach 8th (2d8), and 16th level (3d8).

Cripple

Concentrating on a target you can disrupt their nervous system with your action. Choose a target

you can see within 30 meters, they must make a Constitution saving throw or suffer one of the following conditions:

- Poisoned condition until the end of their next turn
- Paralyzed until the end of your next turn
- Cause 1 level of exhaustion

Rejuvenation

With a touch you are able to rejuvenate and heal others. With your action you may heal a target creature you are touching in one of the following ways:

- Remove Poisoned condition
- Remove 1 level of exhaustion
- Remove Category One Radiation Sickness

Psychokinesis [Intelligence]

The ability to turn mental energy into motion. Psychokinetic talents can attack and defend against physical force, as well as create and direct energy. With a successful Intelligence (psychokinesis) check you may psionically lift and manipulate unattended objects within 10 meters that you can see. The DC is 10 to lift 5kg, +1 per 2kg of mass. While you can use psychokinesis to perform delicate work, the range for fine control such as fighting, lock picking, or crafting is only 3 meters. Additionally, objects move slowly, equal to your walking speed. You can hold the objects so long as you concentrate, for up to one minute.

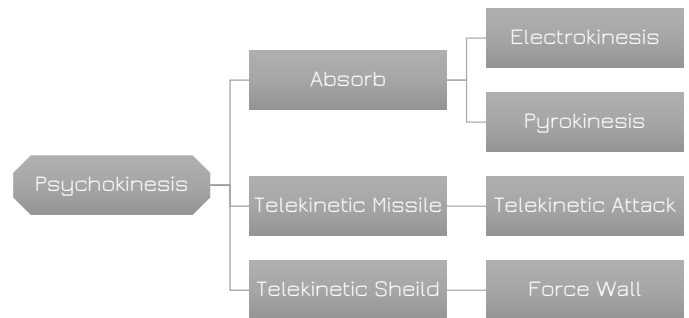

Absorb

As a reaction to taking damage from heat or electricity, you can absorb and dissipate some of that energy. If you chose to do so, you roll 1d10 + Intelligence modifier + character level and negate this much of the energy damage.

Electrokinesis

You can build up and release massive discharges of electromagnetic energy. As an action, you can release a burst of electricity at a target within 5m as a talent attack. You have advantage on the attack roll if the target is wearing metallic or power armor. On a hit, the target takes 1d8 electromagnetic damage, and can't take move actions until the start of its

next turn. Sensitive electronics, computers, and instruments targeted are utterly destroyed by this ability, and you can even attempt to charge some small batteries on a psychokinesis DC 15 check. Your Electrokinesis damage increases by 1d8 when you reach 5th level (2d8), 11th level (3d8), and 17th level (4d8).

Pyrokinesis

With this talent you can agitate materials to cause combustive oxidation. As an action you can summon fire around you which sheds bright light in a 3-meter radius and dim light for an additional 3-meter. Your fire disappears if you dismiss it as an action or if you attack with the flame. When you activate this talent, or as an action on a later turn, you can hurl the flame at a creature. Make a ranged talent attack. On a hit, the target takes 1d8 thermal damage. Flammable objects you hit burst into flame if they are not being worn or carried. Damage from Pyrokinesis increases by 1d8 when you reach 5th level (2d8), 11th level (3d8), and 17th level (4d8).

Telekinetic Burst

As an action, you release a burst of pure telekinetic energy at one creature you can see within 30 meters of you. The target must succeed on a Strength saving throw or take 1d6 force damage. If the target takes any damage from this attack and is Large or smaller, it will be pushed in a straight line 3 meters away from you. The talent's damage increases by 1d6 when you reach 5th level (2d6), 11th level (3d6), and 17th level (4d6).

Force Wall

On your action you summon an invisible bubble of telekinetic energy, centered on you. The sphere extends 3 meters from your center in every direction. This barrier lasts until the end of your next turn. Anyone inside the barrier who is attacked from outside the barrier gains resistance against impact, bludgeoning, piercing, and slashing damage.

Telekinetic Missile

As an action, you hurtle debris and items at one creature you can see within 20 meters of you. The target must succeed a Dexterity saving throw or take 1d6 impact damage. If the target takes any of this damage and is Large or smaller, it is knocked prone. The talent's damage increases by 1d6 when you reach 5th level (2d6), 11th level (3d6), and 17th level (4d6).

Telekinetic Shield

As an action you surround yourself with a skintight shield of telekinetic energy. Until the end of your next turn, you have resistance against impact, bludgeoning, piercing, and slashing damage.

Telepresence (Wisdom)

The ability to perceive things outside the scope of the human senses, the telepresence skill allows you to project your senses a great, almost limitless distance. A successful Wisdom (Telepresence) check allows you to see, hear, smell, or feel a person, place, or thing in real time at distance as if you were in an adjacent square. You must possess something relevant to the target: a personal belonging, a piece of an object, or a photograph of a location. Your senses remain at the target so long as you concentrate, up to one minute. The DC to see a location is 10. The DC to see and hear a location is 15. Any additional sensation requires a DC 20 Wisdom check. This ability automatically fails if the target no longer exists.

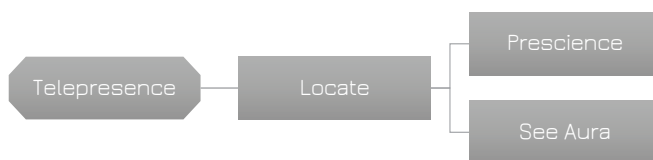

Prescience

As an action, you can attempt to glimpse the structure of reality. With these insights, the next time you make an attack roll, a saving throw, or an ability check, you roll a d4 and add it to the total. The insights fade quickly, and you if you do not use them within 1 minute the bonus is lost.

See Aura

With an action, you can perceive the auras of a living creature. Until the end of your next turn you have advantage on Wisdom (insight) checks against the target, and you can see:

- Whether the creature has any diseases or antipathy
- Whether a creature possesses and Psionic skills
- The presence of cybernetic upgrades in a creature

Locate

Rather than cast your mind to a distant place or person, you can try to trace their position. You must possess something relevant to the target: a personal belonging, a piece of an object, or a photograph of a location, and succeed a Wisdom (telepresence) check DC 15. If you succeed you can point to the location within 1 d4 kilometers

of accuracy. Intelligent creatures may make a Wisdom saving throw to hide their presence

Telepathy (Charisma)

You can intercept and project thoughts and feelings to living creatures with an intelligence score of at least 2. A Charisma (Telepathy) check will allow you to send your thoughts or "hear" the surface thoughts of one target you can see, who is entitled to a Wisdom saving throw. Creatures rarely think in simple words, so this is probably a jumbled and complicated stream of conscious activity, you will receive glimpses of imagery, words, and concepts that may be confusing without context. Your check determines the scope of information you receive.

DC 10: Learn the subject's current mood, train of thought, and activity.

DC 15: Identify the whether the subject is being forthright or obfuscating in a conversation.

DC 20: Detect the presence of Antipathy in the subject.

You can also send your thoughts to another you can see. To communicate words the target must understand your language, but you may just as easily send emotions and imagery. As an action you can send one statement, up to 10 words. Your mode of communication dictates the DC. A target may ignore your sending with a Wisdom saving throw.

DC 10: Communicate with someone who speaks the same language.

DC 15: Communicate across a language barrier.

DC 20: Give a general impression to an animal or communicate with an unseen but familiar target.

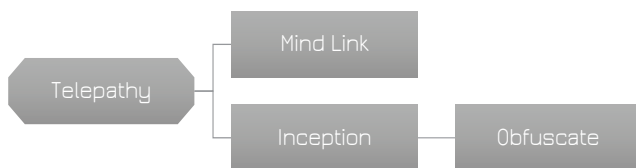

Mind Link

As an action you can create a telepathic connection with up to 6 creatures whom you can see within 30 meters. The link lasts for as long as you maintain concentration and is not limited by distance once you have established the connection. While linked, the creatures may make a Charisma (Telepathy) check to project their thoughts to all those in the group.

Inception

As an action you implant the notion of an image or sound in the mind of one target you can see. The illusory effect only lasts for your turn but could be almost anything you can imagine.

Sounds can range from a 20 to 90 decibels. It can be a voice, an alien screech, or the sound of distant machinery or gunshots, or any other sound you choose. Whatever your incepted hallucination, it lasts until the beginning of your next turn.

Images can be of any objects or pictures you can envision, but must be less than 2 cubic meters. The image can't create any sensory input other than sight, and it cannot emit light to the target, but it could be animated such as information on a computer display, an imagined chair, or a ghostly child. The image disappears at the beginning of your next turn.

Obfuscate

Choose one creature you can see. As an action, you can cloud their mind, effectively rendering person and equipment invisible until the end of your next turn unless the target succeeds a Wisdom saving throw.

DESIGNER DRUGS

Whether to heal, or to harm, every civilization has found that through the proper application of a variety of substances, remarkable results can be achieved. From lifesaving vaccinations to powerful pharmaceuticals, the use of drugs to affect the biochemistry of organisms has become an important aspect of modern civilization.

Pharmacology has an important place in medicine, be it in the suppression of symptoms or treatment of a disease, but also has interest to adventurers. Using drugs to stave off fatigue, augment strength or recovery, even taking substances that can enhance the mind can mean the difference between life and death. Then again, so can becoming reliant on chemicals to function. Even in the distant future, addiction is a very real problem. The designer compounds presented here are common pharmaceuticals used by adventurers in the arc, and by some recreationally.

Using Drugs

When you take a dose of a designer substance, the onset is 1d4 rounds. After which time the drug comes in to full effect. Normally substances do not act this quickly on the body, but most designer drugs include accelerants to make them practical for immediate use.

Once in effect these drugs generally have a limited duration, but abuse can have serious and lasting side effects.

Abuse and Addiction

Designer drugs are extremely potent and can cause serious side effects, which will be detailed in the description. When you take more than one dose of a substance per long rest, you incur a chance of developing an addiction. Each dose taken after the first requires a Constitution saving throw against a DC set by the drug's addiction classification.

Mild. These drugs are rarely habit forming and the DC is 10.

Moderate. Habitual use is not unheard-of, and the DC is 15.

Severe. These substances can often lead to abuse. Save DC is 20.

Cost of Addiction. Each month that you live with addiction you develop 1 point of Antipathy. While you are not under the influence, you suffer the listed side effects of your chemical addiction(s).

Recovery. The road to recovery is a hard one. If you can make it a month with out use of substances, you can make a DC20 Constitution saving throw to remove the disadvantages of the side effects. However, you will find that it is easy to fall off the wagon. Each time you use a substance, you are at disadvantage to any addiction saving throws.

Drugs are Dangerous

Addiction and Abuse are real, very serious issues, and in no way are we condoning the abuse of narcotics or making light of the seriousness of addiction. The fictional drugs here are designed to have minimal side effects, but real narcotics can and will cause serious, lasting damage if abused.

If you or someone you know is struggling with addiction, please, seek help.

Common Designer Drugs

Rexophenaltestosteron (Wrecker)

Wrecker numbs you to pain while providing increased motor control and decreased empathy. +2 Con, +2 Dex, Advantage on Wisdom and Charisma saving throws. 1d4 hour duration.

Side Effects: Disadvantage on Wis and Cha checks. Wrecker makes you heartless and practically incapable of feeling remorse but also severely impairs emotional intelligence.

Addiction: Moderate

Prospherium Seretonin (Serenity)

An extremely potent nootropic, Serenity augments executive function, producing savant like effects for a short time. Gain +2 Int, +2 Wis,

and advantage on Intelligence Checks for 2d6+3 minutes.

Side Effects: Following use, you have disadvantage on all intelligence and Wisdom checks and saves for 1d4 hours.

Addiction: Severe

Polychlorin e6 Gama (Nighteyes)

Administering these eyedrops will give a human, Xhu, or Urroru darkvision to a range of 10 meters for 1d4+6 hours.

Side Effects: Causes minor eye irritation when it wears off, Disadvantage on visual perception checks.

Addiction: Mild

Dexomethal Phencyclidine (Plus Ultra)

This dangerous combat drug will send you into a berserk ferocity for 2d4 minutes. While in effect you gain 1 hit dice, +4 Strength, +10 meters to land movement, and you have resistance to bludgeoning, piercing, and slashing damage.

Side Effects: While high on Plus Ultra you have disadvantage on Intelligence and Charisma saving throws and checks. You cannot concentrate enough to use Intelligence skills.

Addiction: Severe

Yeloxomellenin Glycophosphate (Noble Death)

Derived from a compound used by Ba'alur Shamans, inhaling this smoke inhibits fear, granting total immunity to frightened, anxious, and shock conditions for 1d8+8 minutes. Once per long rest, Ba'alur who use Noble Death can exhale a 5 meter cone of poisonous gas which causes 4d6 damage and the poisoned condition for 1d8 minutes on a failed save (Con., DC 14).

Side Effects: Noble death causes sever weakness of the immune system. Following ingestion, you have disadvantage on Constitution saving throws and death saves for 1d4 days.

Addiction: Moderate

Lithaltheanine (Evernight)

A potent psycho active stimulant, Evernight stabilizes the mood and inhibits exhaustion form sleep deprivation. One dose allows you to gain the benefits of a long rest without sleep, standing guard or performing other light activities. You will not require sleep for 48 hours after a dose.

Side Effects: Prolonged use is extremely dangerous. Each 48 hour period with out sleep results in a cumulative -1 penalty to Wisdom, up to -5. At this point you gain the poisoned condition until you can be treated by a medical professional and sleep for 24 hours.

Addiction: Severe

SECTION 12 THE ARC

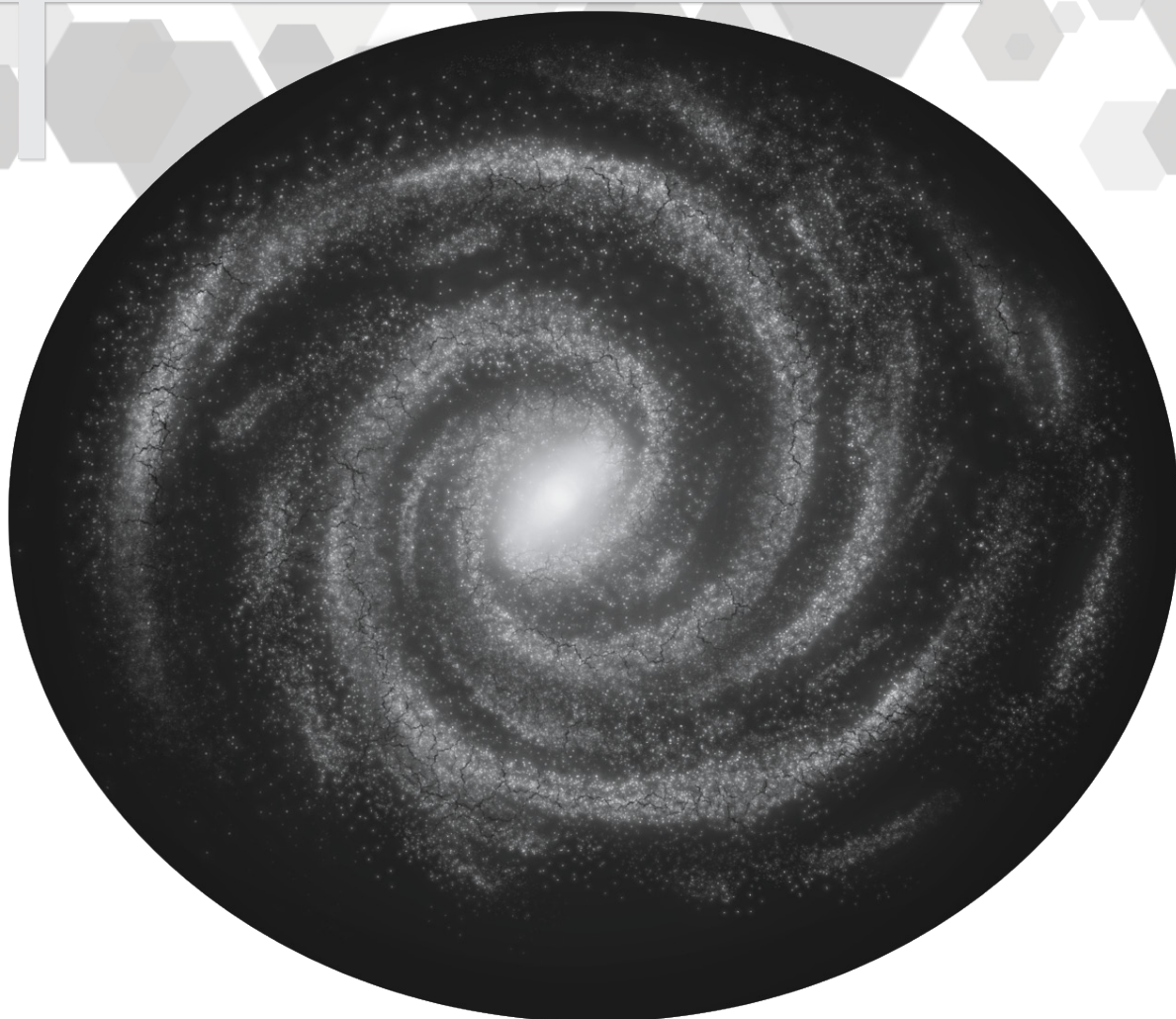

The Arc, an expanse of space that stretches from the inner edge of the centaurus arm, to the outer arm at the galaxy's edge. This vast region is more than fifteen thousand light-years across, and yet is but a fraction of the galaxy. Still, this sea of stars is home to ancient wonders, unique phenomena, and dangerous life.

HISTORY OF THE ARC

The history of the Arc stretches back tens of thousands of years, across countless civilizations that have risen, and fallen, to the march of time. Compared to this breadth of ages the epoch of humanity's ascent to the stars is comparatively small.

Those who Came Before

An eon before life emerged among the worlds of the people today, old worlds gave rise to ancient minds. Beings we would find so alien and unrecognizable built civilizations both vast and terrible in a nascent galaxy. Like us, each would in turn raise their eyes to the stars, wondering if they were alone in an infinite cosmos, or if perhaps, another star shined with life. These beings, alike only in dignity and age, reached out, and rejoiced.

They were not alone. At the behest of the wisest, the ancients convened a great council of the stars, hundreds of worlds all connected as a community. Together these protogen peoples harnessed ancient sciences we have yet to imagine and forged the future of the galaxy through their endless patience. And yet, more than this we do not know.

From some dark corner of the void came war, one so terrible and vast that the galaxy was awash in death. World after world vanished, burnt out and salted. After tens of thousands of years, as the light of life fled the Arc, the Protogens saw a new hope. With gentile patience they reach out and scooped up the seeds of the future.

New life had blossomed on young worlds, worlds rich in the stardust of ancient stellar forges, rich in water and carbon, iron and exotic metals. The light of the protogens faded, and a new light emerged.

The Endless Empire

Time-worn monoliths and dusty slates of ancient stone record what is now thought to be the last message of a protogen civilization. Etched in platinum and granite the words command a congress of young races to take up the mantle of guardians and protectors of the roads, a network of traversable wormholes.

More than fifteen thousand years ago the congress of Xhu Akreen and Thothid would mark this day as their Ascension, becoming the Magisterium of the Congress. Thousands of enormous ships would set out to the far edges of the Arc baring these colors, each with a mission of colonization and conquest.

Age of the Magisterium

As mankind erected the great pyramids, the Magisterium erected an empire across the galaxy. World after world fell beneath the banner of the Xhu Akreen, while the Thothid quietly withdrew to the shadows of history. Each new civilization discovered was given the chance to join the magisterium as serfs, or as slaves, but the

imperialism of the Xhu was absolute.

On each world a great pillar was hewn from stone cementing the rule of the Magisterium. The stone bore the same commandments codifying language, sciences, history and communication with the great network of worlds. Each cornerstone acted as an anchor of civilization, never yielding or changing, through the march of millennium.

From the Fires

Nearly twenty millennia after the Magisterium was founded, the galaxy would be forever changed due to a pale blue dot at the end of the Arc. Mankind set out to reach the stars, and in the year CE 2118 the first interstellar colony ship reached Alpha Centauri A, the star Rigil Kant, and the habitable moon HuoYi. Proving to be profitable, Instar Heavy Industries follows suit, colonizing the barren world of Higel around the nearby star Toliman. But this event would set in motion a diaspora of colony ships from Earth and result in a rapid destabilization of the political balance of the Sol System.

Less than two centuries later, as the largest corporations diverted capitol away from the Sol system, resources became scarce and bellicose rhetoric became loud. At the end of the 23rd century a hungry and desperate Earth turned bitter eyes to the stars, and thus began a nuclear Armageddon that burnt Earth, Mars, and the Jovian colonies to ash. Limited to the speed of light it would be years or decades before the colonies would watch as the birth place of mankind died, and with it, the past.

The New Order

The skies were ashen, the seas poisoned, and the soil blackened. Yet this would not be the end. The ruins of man were the bones of giants from which the new order would grow, the mighty would forge a new world. It is hard to separate the myth from the history, but a decade after the war was concluded and the grave silence of death hung heavy over the inner worlds, Several charismatic and ambitious commanders rallied the remaining artificially enhanced genetically isozymic soldiers to their banners.

Reestablishing order, the commanders set about codifying a new set of laws and regulations, establishing the foundations for what would become the Imperium. The AEGIS were united by purpose, and by drive: survive at all costs. They did more, they thrived. In scant decades they had reclaimed and rebuilt two worlds and a dozen outposts. In less than a century they had achieved more than a humanity had in five.



How the AEGIS were able to reproduce and repopulate remains unknown. It should not have been possible, and yet, tens of thousands of super soldiers produced millions in a matter of years. Some believe it was the radiation and mutation, others attribute it to divine providence. The Imperium's own records are silent on this.

The Great Diaspora

Ancient records show that at least two hundred ships carrying no less than fifteen thousand souls, seeds, and livestock embarked from Earth in the centuries before the destruction. Made possible by advanced electromagnetic proluptions and primitive KZM shielding, at least a million colonists ventured into the unknown, entering cryogenic sleep with little or no guarantees of survival. Bravery, foolishness, greed; whatever the reason, between seventy and two-hundred years later these ships would make planet fall and begin building new homes on the worlds there.

This great diaspora lasted nearly two hundred years and spread the seeds of mankind amount nearly all the potentially habitable planets within the nearest fifty lightyears. Yet the economic cost of this venture crippled the Sol system, as the best and brightest made their way into the unknown aboard vessels that syphoned trillions of credits from the inner planets.

A Corporate Alliance

For Instar Heavy Industries, the paradigm changed when their most ambitious colony

ship arrived at Autem, only to discover that they were not alone. At first the Ixaxian outpost hid from the colonials, until realizing that they were not members of the hostile Magisterium, but something new. First contact was carried out by corporate specialists who were eager to learn everything the Ixaxians had to share, which was very little. However, the insectoid Aliens were more than willing to help the corporation reconnoiter other human Colonies.

Aboard Ixaxian ships, corporate representatives visited nearby colonial planets forging a loose network of allies.

The Horizon of Tomorrow

Had the Sol System not succumb from within, then the moment that changed the galaxy may never have come. At the dawn of the third millenium an experimental ship tested the first Horizon Drive. The ship's mission was military reconnaissance of the HouYi and Higil colonies, but the Captain of the Coeus would take on a secondary mission to investigate a massive interstellar body in the Rigil Kant system that seemed to be changing course and speed to approach the Sol System. This was the Ephari WorldShip Envoi.

The revelation that they were not alone in the universe changed the nascent empire's fate forever. From that pale blue dot an armada appeared in Rigil Kant system and demanded the absolute subjugation of the colony and offered a hand of firm peace to the Ephari. The Congress of the Sol Union met the aliens with great pomp

and circumstance and the Ephari shared with the Union millennia of science and technology. Many Ephari came to believe that their long exodus had come to an end, as surely a race who had overcome the barrier of space itself must be the chosen.

From Union to Imperium

The Colonial Government of HouYi collapsed under riots and chaos as word that not only had earth come to claim them, but that humanity was not alone. The Emphyreans landed tens of thousands of peacekeepers on the planet and enforced a new rule of law. It took less than a month before the colony was under complete control.

Meanwhile, the Imperial Council of Rex Gaia met with the Corvinan of the Ephari. These ethereal aliens believed that they had been tasked with seeking out the chosen race, the people who bore the dominus of the galaxy by ancient decree. As this legend spread the Congress of the Sol Union saw it as confirmation of will of the Twelve Commanders. Humanity must be reunited, by any and all means. It was in August of the year that the Congress dissolved the Sol Union, and became the Imperium of Sol.

A Collision of Destinies

The peaceful first contact with the Ephari perhaps precipitated the Imperium's foolish bravado, and assumption that they alone held dominion over the stars. In the CE year 2932 or Magisterium year 15,904 the Imperium and the Magisterium came into contact for the first time in orbit of the colony world Cocytus in the Stygian system. The Magisterium demanded the colonies absolute surrender, and the Imperium responded with a brutal show of force. The battle was brief but the devastation absolute.

The Carrier Armitage was the only ship from either side to survive, limping back to imperium space with a skeleton crew and a dire warning. The battle cry of the Imperium was echoed in the halls of the Magisterium and the Armitage War began, scorching the galaxy for more than a century.

War Stories

In the fires of conflict heroes were forged from the coal of countless lost lives. Neither side initially made any attempt to sow peace, or even communicate. The Magisterium possessed superior numbers and more experience in space battles, but the Imperium possessed absolute mobility. Two decades into the war and the Magisterium had been pushed back beyond the

colonial lines. But, the technical advantage would not last, as the Magisterium reverse engineered the Horizon Drive, and disseminated that technology across their vast empire.

With the advantage of mobility lost the war changed for the Imperium. Guerilla tactics no longer sufficed, and numbers became the deciding factor. The last decade of the war showed the Imperium that in a protracted war, they lacked the resources and capability the vast industry of the Magisterium had built over millennia. The war was turning into a brutal stalemate.

While the Magisterium and Imperium battled for dominion, colony worlds that refused serfdom to either side lead a revolution spurred on by corporate interests and ideologies of old earth. These Corporate Free Colonies and their alien allies would wrest control of a dozen worlds from both the imperialistic powers, unifying against conquest.

End War

Fifty years ago, the Armitage Wars came to a sudden end with peace the only victor. It was not corporate upstarts flying democratic ideals in the face of the mandates for which the empires stood, but a single call for help which would bring the arc into some semblance of peace.



An impossible signal was detected by forces throughout the galaxy, a signal that the Imperium and Colonies recognized as an SOS, in Morse code. But it was the means of this transmission that garnered attention - it was being broadcast into the confined quantum entanglement networks of the Arc. The thought that there was a method of breaking into the most secure communication imaginable forced the Imperium and Magisterium into action, while the Free Colonies recognized the humanitarian need of whom ever was calling out for help.

Within relative hours, each faction had mobilized a forward fleet and committed to the source of the signal, a tiny star with no name or importance.

Ancient Shadows

The fleets arrived in the Fane system within hours of each other only to witness apocalyptic destruction. A roiling venta-black armada had scoured two moons and an entire colony of life. The second planet in the system was under devastating siege and would not last more than a few more hours. Corporate ships rushed to make planet fall and rescue survivors from the devastation but came under brutal assault.

As the collected forces entered orbit, that dark armada paused the destruction of planet Yeagan only to lay waste to the collected fleets as if they were little more than a passing annoyance. An hour after the initial contact three fleets were largely crippled, and the destruction of Yeagan was nearly complete.

It was an Ephari lieutenant serving on the Imperium carrier Apollonius who heard the tiny voice of hope aboard the corporate medical frigate Caduceus. A bright mind reaching out for someone to listen, a bright mind that could see through that dark armada's strength to their buried weakness. Holding that bright mind, the Ephari reached out looking for something distant and alien that might turn the tide of the battle and found it in the Thothid First Commandant aboard the Magisterium destroyer Cal Urval.

A psionic child among those rescued from Yeagan's surface showed the linked minds that weakness, but it would take all three fleets working in unison.

The Yeagan Accord

The Armitage Wars and Battle at Yeagan had left the Arc weary and worn. Countless brave men and women had made the ultimate sacrifice only to have the dark armada retreat once Yeagan was in ruins. Faced with a force both hostile and superior, the Emperor of Sol and the Supreme Chancellor of the Magisterium of the Congress commanded their proxies to end the war in armistice.

Yet questions remained for which answers were elusive. Who were these colonists and how did they accomplish their transmission? What manner of ability did they possess that allowed them to become instrumental in the counter attack that eventually drove off the armada? The revelation that humans could develop the kind of advanced mental abilities demonstrated by the Thothid and Ephari had dangerous implications.

The Chariot

At the heart of these questions was the quasi-governmental organization that managed the Fane system, Merkabah. In the aftermath of the devastation, Merkabah acted as the directorate and administration of the relief and rescue operations for Yeagan and the outlying territories. By default, Merkaba became the interim government shortly thereafter.

Archeological and historical archives as to the origin of the Yeagan colony were lost to the siege, as were the protogen facilities that had housed the quantum network communications array. Yet the planet Yeagan, the now barren planet Ehtol, and the Yeagan moons were still dotted with protogen ruins. Of interest to the Imperium of Sol were the similarity between these ruins, and a suspected alien outpost discovered on Mars in the twenty second century. To the Magisterium, these ruins match no known Protogen civilization.

To the Frontier

Yeagan has become the edge of the unknown. A neutral trade zone rich in mystery the Fane system sits at the edge of the charted regions of space. Every year hundreds of intrepid explorers set out to see what lays just beyond the end of the Arc. The three factions maintain an uneasy peace, ever watchful of the Fane system, and for the return of that dark armada.

POWERS OF THE ARC

While there are hundreds of planets and outposts in the arc, each with their own regional government and share of adventure, the political topography is dominated by three political and economic powers.

Imperium of Sol



The Imperium arose in the aftermath of the end of human civilization. A strict meritocratic government, every citizen is expected to contribute, even if it means in labor camps. Weakness has no place in the Imperium, every citizen, be they Emphyrean or Colonial subjects are held to extremely high physical and mental standards. While there is a clear class divide between Emphyreans and their subjects, in the outer regions of the Imperium Colonials and Ephari often hold positions of command.

The highest ranks in the Imperium are held by the Emperor of Sol and the twelve Solar Commanders, positions that have existed since the inception of the Imperium. Each Commander is assigned one aspect of the Imperium; Economy, Science, Military, Infrastructure, Culture, Industry, and Order. Two Commanders share each facet and are expected to work together. The only Solar Commander who is not an Emphyrean is the current Sub Commander of Economy.

The Sol System

Star: Sol

Star Type: G2 main sequence yellow dwarf

Habitable Locations: Rex Gaia, Ares

Birthplace of humanity and the Emphyreans, seat of the power of the Imperium, the fate of the Sol system would change the Arc forever.

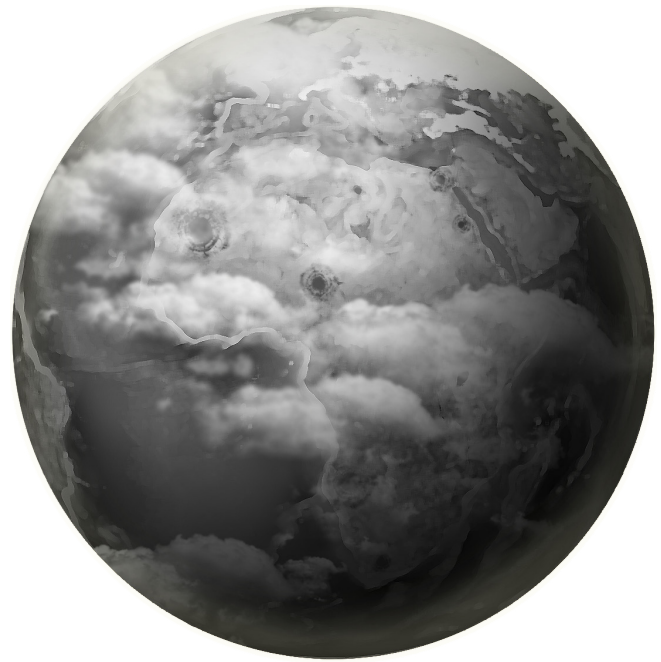

Rex Gaia

Gravity: Medium

Population: 8.2 Billion

Capital: Capitis Terrae

If Sol is the heart of the Imperium, then Rex Gaia is the head of the imperium. The solar commanders located on Rex Gaia maintain the seven pillars of the Imperium; Economy, Science, Military, Infrastructure, Culture, Industry, and Order.

As the ancestral home of humanity, the planet formerly known as earth occupies a seat of prominence, matched only to the great factory world of Ares. It is from Rex Gaia the Emphyrean fleets have set out across the Arc on a mission to take everything humanity has ever claimed.

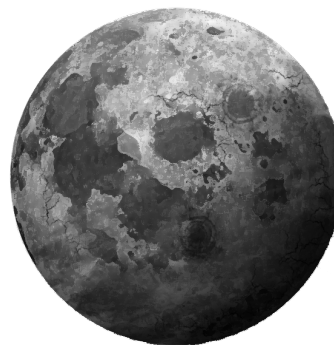

Luna

Parent Planet: Rex Gaia

Gravity: Low

Population: 500 million

Luna is the only natural satellite of Rex Gaia, a tidal locked dwarf planet without a natural magnetosphere. Luna was mankind's first long term colony on

a celestial body and served as a strategic way-point for missions beyond.

Today Luna City is one of the busiest ports in the Sol system. Part mining community where Helium-3 is harvested for Ares, and part port of entry, no ships land on Rex Gaia without passing through Luna's docks.

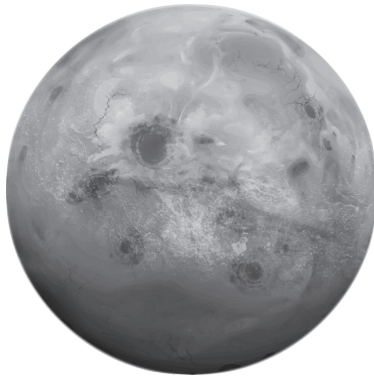

Ares

Gravity: Low

Population: 3.6 Billion

Capital: Opportunity

Once known as Mars, a powerful artificial magnetosphere and the harsh nuclear winter of the Final War transformed the planet into the great

factory world of Ares. Ares was instrumental in allowing the Imperium of Sol to expand to the great empire it was today due to the creation and mass production of the Horizon Drive Technology. While all colonized planets are viewed as equals under the Imperium it is common knowledge that Ares is treated as the first amongst equals, doing business with Rex Gaia as a partner, not a subject.

Ares is a bustling industrial superpower, as the primary shipyard and manufacturer for the Imperium of Sol it is highly restricted to outsiders. Just over one third of the entire habitable locations on Ares are off limits to individuals without at security clearance. Only the bravest and stupidest perform illegal acts on the planet due to the high levels of security and surveillance.

WorldShip Horizon

Parent Planet: Rex Terra

Gravity: Low

Population: 20 thousand

Just shy of 12km wide the Ephari WorldShip Horizon is the first of the next generation of WorldShip created by modern Ephari. Horizon was created as a proof of concept for transporting larger ships using the Horizon drive. Here Ephari diplomats, scientists, linguists, and engineers work side by side with Emphyreans and a rare few Colonials.

Unlike the WorldShip Envoi the Horizon is not equipped to allow for reproduction and is in many ways simply a massive mobile space station. Once a solar cycle the Horizon makes a trip to Alpha systems to rotate crew with the Envoi,

The Alpha Systems

Stars: Rigil Kant, Toliman, Proxima

Star Types: G Type main sequence star, K Type Main sequence star, and M Type Red Dwarf

Habitable Locations: Higil, Houyi

Home to the first human colonists, target of the first Emphyrean Horizon Drive, location of first contact with the Ephari, the trinary Alpha Systems are some of the most historically important

locations to Colonials and Emphyreans alike.

Located just over 4 lightyears from the Sol System, the Alpha systems also serve as the gateway to the rest of the Arc for Emphyreans and Alpha Colonists.

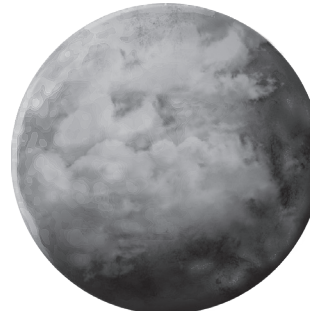

Huoyi

Parent Planet: Sheng

Gravity: Low

Population: 1.2 million

Capital: New Beijing

Huoyi is a habitable moon in orbit of the gas giant Sheng, which orbits Rigil Kant. Unable to secure lucrative rights to Martian interests, the

People's Republic of China chose to launch a colony ship to our nearest celestial neighbor. Named after HouYi the mythological being who shot down the stars. The expedition to HouYi showed humanity that life amongst the stars was possible and profitable.

Huoyi was a barren moon, just warm enough to survive on, with a thin atmosphere, but the perseverance of the original colonists transformed the planet into a flourishing garden moon. Slightly larger than Ares, Huoyi has plentiful water, and the Magnetosphere of Sheng protects the planet from Rigil Kant's solar radiation.

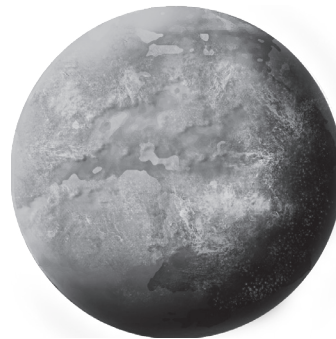

Higil

Parent Star: Toliman

Gravity: Medium

Population: 1.1 billion

Capital: Asimov

Spurred into action by the massive colony ship dispatched by the Republic of China, Instar Heavy Industries,

bet everything on reaching Higil. In addition to the crew of trained experts, they had volunteers signing up to work what was effectively slave labor just to have a chance to go into space. This was the most profitable venture at that point in human history, TV rights, stock, sub goods, and the first product shipment back from Higil made instar trillions, grossly outshining the Chinese colony mission, and triggering what would become the worst economic recession in human history.

WorldShip Envoi

Parent Planet: Higil

Gravity: Low

Population: 20 million

Capital: WorldShip Envoi

Constructed long before the beginning of the Ephari's' known history, the WorldShip Envoi has been the home to the Ephari people for longer than the sum of human recorded history. Whatever their destiny or destination, as the Envoi entered into the Alpha systems, they met the Emyprean scout ship Coeus and discovered there was a civilization capable of superluminal travel.

Envoi now rests in orbit of Higil as a second moon, and heart of a new culture of Ephari. The ancient prophecy of the species was confirmed in there encounter with the empyreans. But what should come next is a mystery, and so, the Ephari orbit a world of humans and posthumans and ponder.

The Ran System

Stars: Ran

Star Type: K2V Main sequence yellow dwarf

Habitable Planets: Aegeris

The Ran system, also known as Epsilon Eridani, is a relatively small system, containing only one major planet, and five dwarf planets. However, the system features two dense asteroid belts. As a result, the system is under a constant asteroid alert, all ships entering the system do so at their own risk.



Aegeris

Gravity: Medium

Population: 4.9 Billion

Capital: Lexicon City

A joint venture between some of the largest earth corporations, the Aegeris colony ships were state of the art vessels equipped with

Quantized Inertial engines that allowed for extreme speeds and the first ever KZM shields. The Ships were constructed to land on the planet and transform instantly in to manufacturing and production facilities.

Aegeris colony was successful beyond any expectations, the plentiful resources of the primordial world and production power allowed the colony to grow exponentially, even going so far as to dispatching missions to other stars and back to earth in less than a century.

Primordial dinosaur like beasts still roam Aegeris, and while the colonial population has domesticated several forms of indigenous creatures, many of the apex predators still hunt the protected wilderness.

Magisterium of the Congress



Claiming to have edict and dominion over the galaxy since the dawn of their civilization, the Magisterium is an ancient and immutable power. The government of the Magisterium is made up of a congress of representatives from each of many dozens of Regencies. Each regency is like a noble house, or nation-state. They hold dominion over a set of resources, and the magnet of each Regency assigns their Magisters to the congress.

Each regency possesses its own political, military, and economic systems, but the executive power of the congress falls to two individuals, the Supreme Chancellor of the Congress and the Supreme Magister of the Congress. Traditionally the Supreme Chancellor is elected by the congress for a term of 10 years, whereas the Supreme Magister is a representative of the Thothid. Regencies pay a tribute to the Congress and their representatives debate matters of law and action of the Magisterium as a whole.

The Anuth System

Stars: Anuth

Star Type: G2 Main sequence yellow dwarf

Habitable Planets: Yehai, Atem-Ur

Ancestral Home to the Xhu Akreen, the Anuth system is a bustling hub of the Magisterium. Located at a nexus of wormhole corridors the star system was a central piece of the magisterium, following the dissemination of Horizon Drive technology, more beings than ever come to the Anuth system.

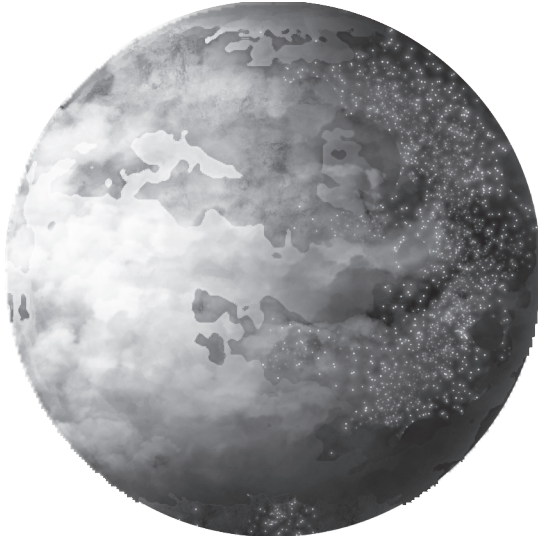

Yehai

Gravity: Medium

Population: 12 billion

Capital: En-Galen

Yehai is a planet slightly larger than earth and slightly farther from its parent star. The tidal force of its planetary sister Atem-Ur makes Yehai highly volcanic, covering much of the surface in black soil and ash. Yet this makes the soil lush and nurturing, the constant magma flow heats a world that might otherwise freeze, and the abounded flora provides an ample food supply.

A ring of orbital elevators and space stations ring Yehai, allowing lift from the planet with little effort, the ancient stations are practically hewn of ancient stone, so simple and elegant their design. Yehai is an ancient world, with roads and cities that date back tens of thousands or years, everywhere one goes the history and gravity of the Magisterium is present.

In recent years, many Xhu born on the edges of the Magisterium have begun to make pilgrimages to Yehai, the ancestral home world. Many of these Xhu have never been to the planet and lived in remote colonies for many generations.

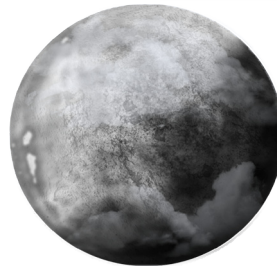

Atem-Ur

Gravity: Low

Population: 4 billion

Capital: Utu-Uk

The only natural satellite of Yehai is the Ares-sized moon Atem-Ur. This tidily locked world is home to the great archives of the Magisterium. A geologically active planet, Atem-Ur has a stable atmosphere and magnetosphere, making it easily habitable despite its low gravity.

Atem-Ur is considered sacred ground, and rests directly above the site of the monolith. Here the magisterium operates its many houses of learning, and the collected knowledge of their great empire is reviewed and researched by an army of academics. The oldest of these libraries is known as the Protogen Archives and houses the records of the civilization that supposedly elevated the Xhu to a star fairing civilization.

The Yogoth System

Stars: Yogoth

Star Type: M4 Red dwarf

Habitable Planets: Ulgul Bhaat

Yogoth is an ancient red dwarf that has nearly exhausted the fuel at its stellar core. Unlike most stars, Yogoth drifts just up and beyond the standard galactic ring, which bathes the system in exotic intergalactic radiation.

Ulgul Bhaat

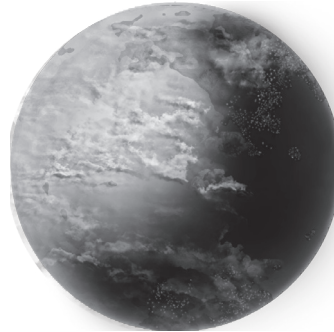

Gravity: Low

Population: 60 million

Capital: Port of Ulbahgath

Were one to ask a Thothid in the Arc of their home world, they would reply that they do not know. If you were to ask a Thothid where they are from, and they will all tell you the same thing: Ulgul Bhaat.

This watery world has a highly irregular shape and appears to have been formed by the controlled collision of two smaller moons creating one larger body with mountains that reach beyond its dense moist atmosphere. This unique geology and formation allow for efficient planetary landings and has made for several scientific studies. All young Thothid who are dispatched into the Arc are reared on Ulgul Bhaat by the finest Thothid, Xhu, and Urroru instructors. This is also the only Thothid location that is both known, and open to outsiders.

The Stygian System

Stars: Styx

Star Type: FV White dwarf

Habitable Planets: Cocytus

After nearly four centuries practically adrift, the Hadion Corporation's only colony ship entered the Stygian system, purely by accident. A crudely built ship, the vessel was unprepared for the journey and left radically off course and reached dangerous speeds that nearly destroyed the sleeping colonial passengers. As the ship approached the system, damage sustained traveling through the helioshock of Styx finally alerted the crew who was awoken from cold sleep.

They found that they were in uncharted space aboard a critically damage ship and hurtling towards a star that meant certain death. The Captain calmly named the star "Styx" as it was the river that would carry the crew to death.

It was here that the Magisterium and Imperium first traded blows.

Cocytus



Gravity: Medium

Population: 200 million

Capital: Port of Ulbahgath

After a short mutiny aboard the Hadion 1 Colony ship, the crew was able to perform a slow decent of the massive ship into the freezing ocean of the third planet in the Stygian system. Not fully inside the habitable zone of the star, Cocytus speaks to perseverant and determination of the colonists.

Cocytus is the largest population of humans

under direct Magisterium jurisdiction, and has become a point of hot political debate, as the colonists chose to side with the Magisterium during the conflict.

The Banershem System

Stars: Baneris Minor, Baneris Major

Star Type: Mx Orange-Red dwarf, AIV Blue Giant

Habitable Locations: Thyot Mining Station

Nearly fifty thousand years ago the Banershem system contained three stars. A degenerate white dwarf of the set went super nova, but the highly magnetic younger stellar companion survived though much its stellar atmosphere was obliterated creating a unique kind of red dwarf. The intense gravity of the largest star in the trinary system captured most of the material of this violent event creating a unique accretion disc containing highly exotic metals and neutronium samples.

As the Armitage War reached its zenith, the Magisterium did not have the required materials to keep up with the need for advanced warships and Horizon Drives. The Banershem system's unique resources and remote location made for the perfect shipyard.

Thyot Mining Station

Gravity: Medium

Population: 200 thousand

Built into a dwarf Planet rich in irons and radioactive isotopes, Thyot was originally a hasty mining outpost, but has grown more than exponentially since the Yeagan Accord. Capable of handling near one hundred mining ships in proper rotation, Thyot is a hub for miners, merchants, and miscreants. The Magisterium will eagerly buy minerals and material, so citizens of the Magisterium and freelancer's alike come to work the Thyot mining belt for the large payouts, regardless of the risks.

Being open to enterprises and merchants, the fact that Thyot is the closest Magisterium facility to the Fane system has led to significant security concerns. The fact that the Imperium has purchased material from the belt via the corporations has also not gone unnoticed. However, the cost to maintain a blockade of the region is not feasible.

Corporate Free Colonies



This loose knit alliance began with the corporate colonists of the Aparahelion, a massive vessel of Vyros Incorporated which carried twenty thousand souls to the planet Autem, in the Helvetios system only to discover an Ixaxian outpost there. As the Imperium and Magisterium began their long and bloody interstellar war, the loose knit group of colonies came under fire. Realizing the Imperium already had Horizon Drives, the Ixaxians shared the technology with their human allies, allowing for a coordinated rebellion and counter attack.

Collected, the Corporate Free Colonies meet on Autem in the Corporate Council, a collection of the vice presidents or representatives of each colony or corporation. Each corporation governs its colonial interests as, well, corporations. Corporate citizens are expected to work for and earn for the company. Those colonies that rebelled against their corporate rule tend to be viewed as a bit suspect within the alliance. The closest thing to a guiding force for the corporate free colonies is the Ixaxian Elder Council. This group of scientists and thinkers rules the Ixaxian Commune, and by extension harbors carries the most weight in the collected Corporate Council.

The Helvetios System

Stars: Helvetios

Star Type: G2IV Main sequence yellow dwarf

Habitable Planets: Autem, Quintus

Center of the Free Corporate Colonies, the Helvetios system was first colonized by Vyros Incorporated, and then again by Instar Heavy Industries, who made first contact with the Ixaxians on Autem. Of the system's eight planets, the gas giant Dimidium orbits so close to Helvetos that it burns bright as a second star in the sky.

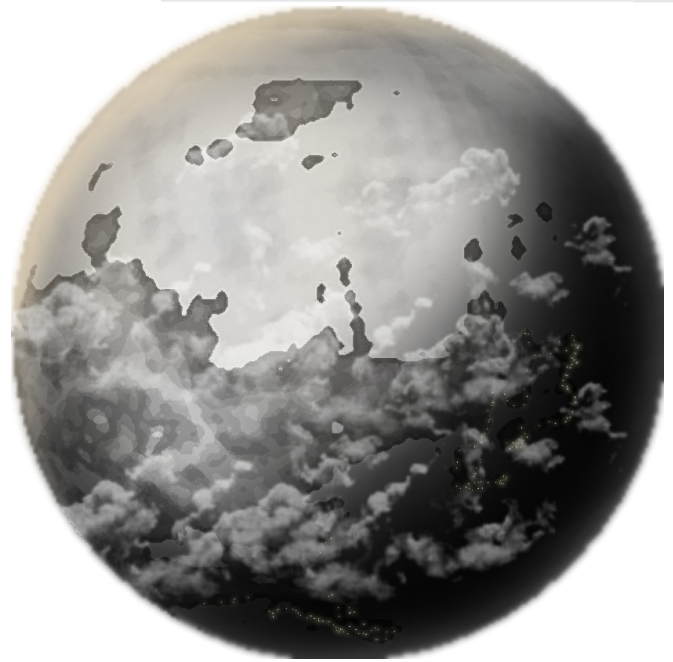

Autem

Gravity: Medium

Population: 6.8 Billion

Capital: Pegasus

Autem is a planet of beautiful coasts, shallow crystal clear oceans and expansive deserts. While the planet orbits close to the star, the magnetosphere of the bright green gas giant shields Autem from radiation and creates the illusion of two suns. This has made Autem something of a resort planet, offering 200 thousand kilometers of coastline beaches and attractions to attract tourists.

Vyros Inc. partnership with the Ixaxians began on Autem, and while the advanced creatures were reticent to share their technology, corporate negotiators did strike up transport agreements in exchange for labor, something the Ixaxians suffered severe shortages of. Aboard horizon ships, the Corporations began to intercept Subluminal Colony ships and expand their reach to nearby colonies.

Quintus

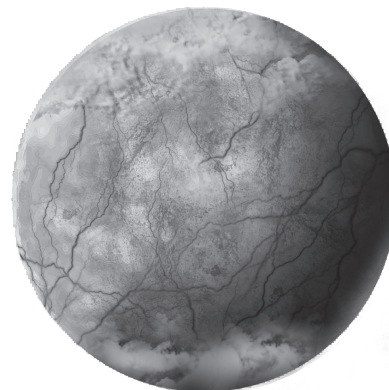

Gravity: Medium

Population: 1.8 Billion

Capital: Port Demitas

This rocky barren world is something of a stellar anomaly; the core of an ancient star trapped in orbit of Helvetios millions of years ago.

Quintus is incredibly rich in exotic minerals

and elements, as such Port Demitas acts as the central hub for Corporate research and manufacturing. Currently Quintus is the largest creator and distributor for battery packs and charged materials in the Alliance and the Imperium.

During the Armitage war between the Imperium and the Magisterium Port Demitas was key manufacturer of ships for the Corporate Alliance. Given full specifications for the Ixaxian Horizon Drives, the resources of Quintus allowed the Alliance to avoid getting crushed the war.

The Tzax System

Stars: Tzax,

Star Type: K0 Main sequence Flare Star

Habitable Planets: Ixax

The Tzax system contains the home world of the Ixaxians. It is believed that the star system is the result of the collision of two smaller stars. Tzax is an irregular flare star with extremely high iron metallicity, resulting in highly unpredictable electromagnetic and plasma bursts. Furthermore, the circumstellar ring of Tzax is highly charged and difficult to navigate. All ships entering the Tzax system are advised to have the appropriate shielding.

The hostile nature of the Tzax system allowed the Ixaxians to develop and evolve unhindered.

Ixax

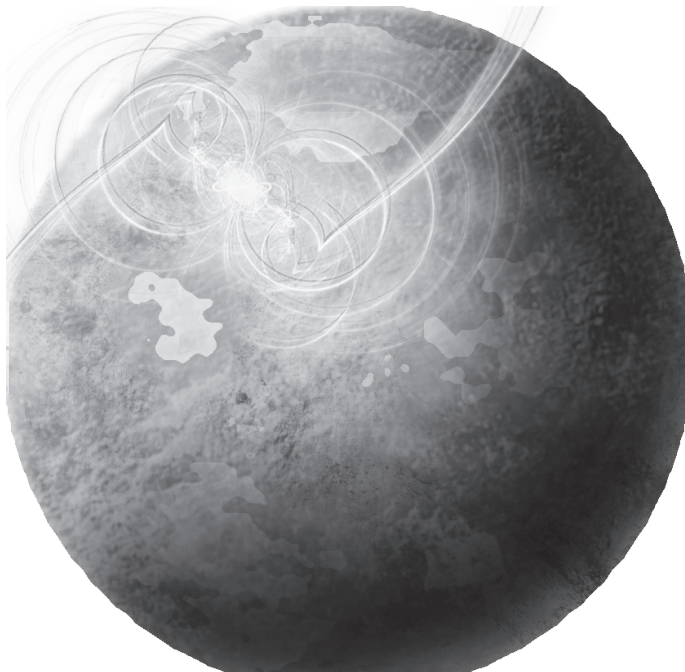

Gravity: Medium

Population: 5.4 billion

Capital: Pazax Axitlck

The surface of Ixax is one of the most alien

places in the Arc. Towering mushroom forests and strange groves of iridescent crystal, the world evolved in exotic and unusual ways under the constant barrage of the flare star.

Most megafauna on Ixax evolved a means to sense the electromagnetic disturbances associated with a flare and have adapted the flares in a number of ways, including living underground. When the Ixaxians became aware of the Magisterium, they dismantled their surface infrastructure and moved most of their civilization underground fearing they would be a target.

Modern Ixax is still less than welcoming, the violence of the Armitage wars showed the Ixaxians that they had every reason to be afraid. Yet their corporate allies have proven loyal and fearless, and millions of colonists live and work on the surface of Ixax filling their need for labor to support the population.

Guthry's Star System

Stars: Guthry's Star

Star Type: K0V Main sequence orange dwarf

Habitable Planets: New Ershwe

The Guthry's System was settled by second generation colonists aboard Ixaxian Freighters shortly after the Ixaxian and Corporate alliance. It was then settled by Seyvul colonists.

New Ershwe



Gravity: Medium

Population: 2 Billion

Capital: Osadhi

New Ershwe is a lush jungle planet with a rich biome. Settled by the Seyvul and Corporate colonists, the planet is one of the most important food production locations to the Corporate colonies. While originally known as Guthry's world, the Seyvul simply called it New Ershwe, and the name stuck. Following a worker's revolt, the corporate colonists started a worker cooperative called the New Ershwe Botany Cooperative or NEBC.

NEBC operates a large farming operation on the planet to ship food to other systems, which they 'share' which they Seyvul. In addition, the NEBC performs research into the native plant life to identify how planets could be terraformed faster, their research has led to an average 8% decrease in terraforming time.

While often used as threats against misbehaving kids the Seyvul would never steal a child away from its family on purpose. Usually the

parents are off the ship for repairs and they didn't know the child was onboard at the time. The NEBC keeps horizon capable ships on standby for such events.

The Frontier

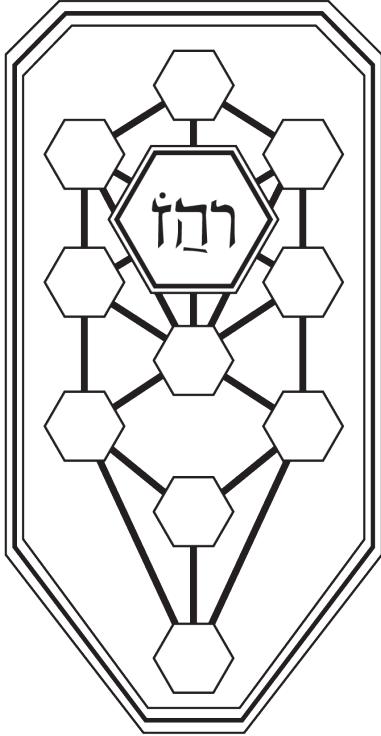

At the edge of the regions of space charted by the Magisterium and the Imperium is the frontier. Here colonists, criminals, refugees, and explorers venture out into deep space in search of something known only to them. Ruins of cultures long lost dot the ancient worlds, and young civilizations peer into the expanse unaware of the vast galactic empires at their doorstep.

The Fane System

Stars: Fane

Star Type: G2VII main sequence yellow dwarf

Habitable Planets: Yeagan, Ethol

Following the devastating losses and crushing defeat at the hands of an unknown enemy, the three factions declared the Fane system as neutral territory. The entire system is a treasure trove of protogen ruins and artifacts created by a race not known to the Magisterium's records. Further the human, English speaking colony seems to predate the colonial period of earth by more than a century.



Yeagan

Gravity: Medium

Population: 2.2 billion

Capital: Heklot

Still showing the scars of battle from the Yeagan Conflict fifty years ago, Yeagan has become an interplanetary hub for the factions of the Arc. The lush blue fields on the primary landmass are sparsely interrupted by cocked craters and a rail system connecting the major cities across the continent. These new developments were built following the planet wide devastation that left virtually none of the original cities standing.

Tens of thousands of intrepid adventurers visit Yeagan every year. The planet is rich in ruins and artifacts and is the first port of call for those brave and foolish enough to explore Ehtol, the Grave Yard or the Dark Star. Despite its challenges Yeagan has a place for everyone; Science, Military, Resorts, Trade, and like anywhere with more than two people, Yeagan has an active underworld.

Ethol



Gravity: Medium

Population: 50 thousand

Capital: Clark Outpost

Orbiting on the outer edge of Fane's habitable zone, Ethol is a barren dead world with a thin breathable atmosphere dotted with thousands of protogen ruins. As part of

the Yeagan Charter no faction was permitted to lay claim to the world or its artifacts, the Merkabah Organization would instead grant licenses to

explore specific sites on a case by case basis.

Ehtol has a powerful magnetosphere, far more powerful than an ordinary planet. This powerful interference makes orbital scans difficult and unreliable. While Each faction maintains a restricted research base inside Terminus Valley near Clark Outpost, the world is open for those with a permit to explore and do research. However, Etohl is extremely dangerous. Random electromagnetic dust storms, and extremely hostile Vorax Raptora cover the planet.

Rumors insist that Merkabah has an esper research facility located on Etohl, built to prepare against another incursion of the Black Armada, which the organization vehemently denies.

The Graveyard



Gravity: High
Population: 1.5 million staff, inmates
Capital: Cerberus Station

Just outside of the habitable zone, this huge rocky planet was the site of the bulk of the Yegan Conflict, as the Black Armada moved

to intercept the fleets of the Magisterium and Imperium. The wreckage and debris have formed a significant planetary ring, only exacerbated by the battle pushing the largest of four satellites into the planet's Roche limit, causing its slow disintegration.

The Graveyard houses the Tartarus prison facility, a network of subterranean volcanic caves filled with the most violent criminals, terrorists, and murderers in the Arc. It is practically impossible to leave the surface of the planet due to the high gravity and constant debris, inmates are launched from Cerberus station in one way orbital drop pods.

WorldShip Phanes

Parent Planet: Yeagan

Gravity: Low

Population: 50 million

Phanes is a step towards a new potential for the Ephari. Built to resemble their original WorldShip, the Phanes is the location of the second Ephari gestation chamber, allowing them to recoup the losses their people suffered during the Armitage wars and Yeagan Conflict. Phanes may serve another purpose as well, as the Ephari have a keen interest in understanding the development of psionic abilities.

The generation born aboard the Phanes are unique among their people as often their purpose is purely research and discovery. Such open-

ended purposes are a relatively new concept to the Ephari who still have not come to grips with the fact that their way of life as nomads has ended. Now the must become explorers, and some have even bug to ask why they began their journey, and who sent them.

The Dark Star

Stars: Puluhra

Star Type: M2VIII Red Dwarf

Habitable Planets: None

Discovered by the Imperium after the Yeagan conflict, the Dark Star is a dim red dwarf located only 1.3 lightyears from Yeagan

Surrounding the dark star is what appears to be the remnants of an ancient and incomplete Dyson sphere, or the frame for one. These so called Puluhra Ruins have become a regular research area for explorers and adventurers since their discovery. However, thousands of foolhardy explorers vanish around the ruins every year, which has led some to speculate that portions of the facility are active or occupied. Unlike the theorized dyson spheres, the Puluhra Ruins maintain equilateral distance from the star and does not rotate.

The Puluhra Ruins have created more questions than answers and the function or purpose of the ruins is currently unknown.

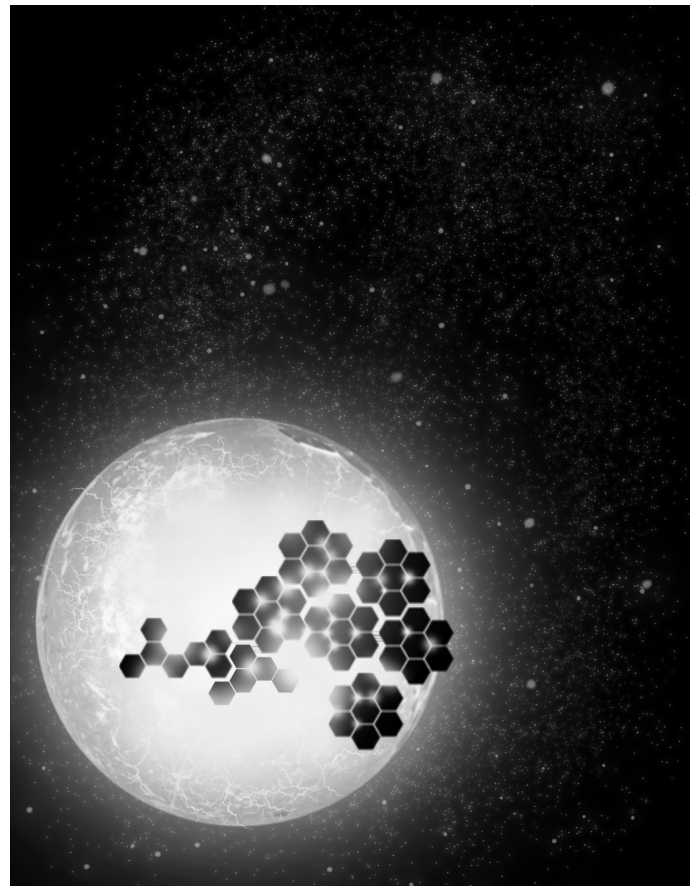

SECTION 13 THE GAME MASTER

You are the narrator, the story teller, and the director. Yours is the most rewarding and challenging roles to play in the game. You are the Game Master. You will set the stage, describe the world, and control the outcome of the events as they transpire. This section will discuss taking on the role of Game Master, creating the universe and adventures you and your party will explore, and mediating the rules of the game.

GAME MASTERY

As the GM you will play the role of every person that the player characters meet, and every adversary they face. You must plan out the adventures that the players embark on and be prepared for the unexpected. You will be the arbiter of the rules, meaning if the outcome or definition of the rules is not clear, it is up to you to make the final call and determine the precedents by which the rules should be followed in your game.

Above all: Role Play! That is the point of the game, take the opportunity to get in to each non-player character and flesh them out. From simple store clerks, to reoccurring villains, role-play each of these unique characters! Doing so creates a living world, and soon you will realize that the setting has taken on a life of its own, with memorable and unique personalities that the players are talking about after each chapter, and characters that fill up your own living legend.

Running the Game

When you and your party gather around the table, it's up to you to take the lead and drive the game. The rules are an engine for the imagination of you and your players. Remember that the goal

of any sessions should be to have fun and share in an adventure. This means at times you will need to mediate between players in and out of the game, as well as set the expectations for the table.

At the Table

The rules of the table are for you to decide; when you start, how long you play, whether you use miniatures or not, and how you judge out of game situations is up to you. There are numerous approaches to running the table, and none can be said to be better than another. When players come to your table, outline what to expect and what the rules are. Some things you should make clear to your players include:

- Be respectful
- Let others speak and act
- Be honest with dice rolls
- Engage as your character
- Above all: Have fun

Rules and Precedent

As the Game Master you will need to make determinations regarding the rules in the book. While the game rules are clear and can be applied to most situations, there are not mechanical rules for everything - and this is a good thing. It is up to you set the precedence in your games.

When you make a judgement regarding the rules, you have set a standard. You have said that under this circumstance, the rules should be interpreted in a certain way. This precedent should be consistent. Once the interpretation of the rules is set it becomes the baseline by which your players will operate. You'll find the rules you establish can go on to become the standards by

THE GAME MASTER

which your players operate with their own groups when they become Game Masters. Be fair, fun, and consistent and you will have a lasting impact on your players and your games will take on a style all their own.

Using Dice

Dice serve as a way for chance to play a hand in the outcome of events. This means that dice are both neutral, and unpredictable. When you let player roll, there needs to be some chance of both failure and success. Demanding players roll forever menial task however can diminish the value of good role playing and having meaningful exchanges. Similarly, if players are never given the opportunity to roll to overcome challenges, they may feel like their destiny is on rails, and they are not part of the story.

Roll for Action

Rolling dice should be a part of the action and the drama, not to dictate exactly what a character can and cannot do. Given enough time, a character with a proficiency should be able to accomplish that task with no meaningful chance of failure.

You don't need to let the players know why you are rolling. If the party being stalked by a trained assassin roll a Stealth check while the party sets up camp for the night and watch the tensions rise. After all they have no idea why you are rolling. This is a great way to build suspense and keep the players engaged.

Keeping Control

Because the dice add chance, you also need to know when to ignore the dice. If the players can derail your story with a critical success, take that option off the table unless you can recover from the event. As the GM you need to be able to adapt and change when things go in a direction you did not anticipate, but you also need to know when to keep a firm hand on the direction of the adventure.

Checks and Challenges

When a player wishes to take an action that is not completely impossible given their character's abilities, and has some challenge or chance of failure, a roll should be called for, usually as an ability check.

Every Action Roll that the players take can fall under one of the ability scores, and test whether they can accomplish their action. In most cases this will take the form of a Proficiency or specialty check, when in doubt however, you can consult

the ability checks outlined below.

Advantage and Disadvantage

As the Game Master, you can strongly influence the outcome of action rolls by granting them advantage, or imposing disadvantage. Players will often gain advantage from special abilities and feats. Disadvantage however is almost always inflicted by some method of attack or situational modifier that you have applied to the players.

Using Advantage

Characters should receive advantage on an action roll when an additional factor is contributing to their success. This could be an environmental factor, the influence of other creatures, or having superior resources. Giving players advantage is also an excellent way to reward players for thinking through a problem and describing or role-playing their action in specific detail.

Using Disadvantage

Disadvantage should come into play when an action roll is made under extreme situations, such as attempting a delicate skill roll during a fire-fight or working without adequate tools. However, the rules do not exist to punish players. Imposing disadvantage or similar penalties on a player because they do not describe their action well or because they do not fully understand the situation is not a good approach. Instead, try rewarding good behavior and encouraging players that are struggling with coaching and feedback.

Awarding Inspiration

You have several mechanisms at your disposal to reward players when they do something exceptional. Inspiration is best suited for situational rewards where the player's actions, role-playing, or heroism shine and elevate the game for everyone. Because expending inspiration can give player advantage on practically any action roll, don't reward players for show-boating and seeking to become the center of attention.

There are no hard and fast rules to when players receive inspiration. A good approach is to award inspiration each session to encourage players to be engaged and have fun. Don't feel pressured to award inspiration of your players spend the entire session on a station haggling over fuel prices and buying ammunition. While these sessions can be fun, there is no reason to cheapen the value of inspiration simply because you played.

Focus on the moments that matter most to you as a game master, and those that elevate the

game for the other players. Cunning, good role-playing, heroism, and even unexpected actions can all be rewarded with Inspiration. When in doubt remember, when players act true to their character's personality traits, ideals, flaws, and axis these are moments that should be rewarded with inspiration.

Awarding Experience

In Advent Horizon, character advancement is driven through experience points, or XPs. As Game Master you can award XPs to players for defeating enemies, overcoming challenges, and completing objectives. Most combat encounters set the number of XPs earned if the players are victorious in the stat block.

When the party overcomes an encounter, the XP is divided evenly among each character, including non-players, who participated. Encounters need not always end in violence, players who are able to defuse or complete an encounter through non-violent means, especially if there is significant risk or danger, should still be awarded some or all of the XPs depending on the difficulty of the situation.

For example, an encounter with a group of raiders that ends with the party trading resources after a tense negotiation with many persuasion and negotiation checks should count as a success, but if the party avoids an encounter entirely with one or two stealth checks, they should receive little or no XP.

Absentees

Eventually you may find that one of your players cannot be at the table for any number of reasons. Players who miss a session should generally not receive XPs for encounters in that chapter. However, if the party has been working towards a larger goal or objective that is finalized or concluded during a session the player missed, consider giving them some of the XP for that objective, based on their contribution.

Objectives

Awarding experience for completing longer term objectives is a good way to balance out sessions that have few encounters. You should set out some or all these objectives in advance, and the difficulty of the objective should determine the XP reward. The XP award for objectives is laid out below.

Minor objectives are small steps such as competing a job for a handler or broker, or finding a crucial piece of a larger puzzle, or completing a mission with an added parameter such as take no damage, don't kill any hostiles, or not be seen.

When players succeed in a task or tasks set forth by contacts or connections, these are minor objectives.

Major objectives are the culmination of multiple actions and encounters by the party, such as capturing a dangerous wanted villain alive, retrieving dangerous intelligence which rests deep inside enemy territory, or completing an encounter or encounters without the opportunity to take rests.

Level	XPs per level	
	Minor	Major
1-5	1d4x10	1d10x10
6-10	1d8x10	1d4x100
11-15	1d4x100	1d6x100
16-20	1d6x100	1d8x100

FORGING THE GALAXY

Whether you set your game in the Arc of Advent Horizon or an original galaxy you conceived, the setting becomes your own as you fill it with the memorable people, places, strange aliens and ancient artifacts your players encounter. Space is huge, filled with countless worlds, moons, space stations and anomalies. We're going to focus on building a campaign in Advent Horizon's Arc, but that doesn't mean you have to.

Science vs. Fantasy

At the heart of the lore and rules created for Advent Horizon is the assumption that few or no supernatural forces are at work. Everything has a scientific explanation or can be understood through scientific inquiry, even the most fantastical elements, like psionic abilities. This means that the rules of the universe of Advent Horizon are, for all intent and purpose the same as ours. However, some rules must bend slightly to allow for our space opera to take place, specifically:

Relativity. Special Relativity poses serious problems to space travel, and the resultant time dilation and restrictions of simultaneity force us to make use of Aeonic Time, a standard temporal metric that is not relative. In our universe, traveling a thousand light years at extremely high subluminal speeds would cause bizarre relativistic effects, and the direction and local gravity would impact as well. As such we rest on simplified concepts to express these events, for the sake of coherent storytelling and fun.

Distance. The Arc represents only a tiny

THE GAME MASTER

fraction of the milky way galaxy, yet it spends thousands of light years. The truth is that space is so vast that it is hard for the mind to fully reconcile. The Horizon Drive allows for super luminal travel through some substantiated pseudoscience. While the hypothetical model for this means of transit exists and is supported, it is still in defiance of accepted scientific theory. The same is true of the electromagnetic propulsion used for subluminal travel.

Xenobiology. There is a compelling body of evidence that complex organic compounds in the right conditions form metabolic structures naturally, and these structures are consistent with common cell structures. Life, if it exists, maybe very like our understanding of biology that we expect, possessing RNA, DNA like molecules, and eukaryotic or prokaryotic cells. In Advent Horizon we assume that this is the case, that all life, even the ancient and unknowable Protogen species, share a similar biomolecular make up based similar macromolecules such as ribonucleic acid, proteins, lipids, and energetic sugars. While the similarities end there, it is still an assumption.

Fun First

Science fiction is built on science, and the laws of nature rarely change. That can make it challenging to run science fiction games, especially when players are well versed in some element of the science involved in an encounter or dilemma the party faces. Players might create a program to automate their research or use some advanced chemistry to create an explosive to escape a trap.

As the game master, your priority is fun. This means that for every scientific reason the party might try to derail your adventures, there should be a scientific reason they can't, unless it's a direction you want to go. You have the advantage of expanding complexity, as the scientific principles of any action increase in complexity, so too does the complexity of the tools and understanding needed to exploit them, and the number of things that can go wrong or fail. For example, if the players are trying to use a lever to pry open a hatch, there are really only a couple things that can fail in this situation, and you should be able to say simply that they can, or that they cannot.

When players with a highly scientific or engineering mind have an idea that could cause issues, but is based on sound scientific principles, unless you are equally as knowledgeable it is hard to argue. As the Game Master this is where you can employ expanding complexity. The more complex their action, and the more assumptions

needed, the more things that can go wrong. Chemical reactions can fail due to the slightest impurities, equipment can malfunction due to the smallest defect, and all kinds of dangerous systems usually have fail-safes to ensure they are not too dangerous.

Finally, remember that you don't need to be a scientist to enjoy Advent Horizon, just as you don't need to be a computer programmer to play video games, or an electrician to turn on your lights. The most advanced technology available to players falls firmly into the realm of pseudoscience, as discussed above. This means that when in doubt, as the game master, you can always rely on that fact.

The Role of the Players

In a universe with as much convenience and comfort as our own, it can be hard to understand why anyone would take to wandering around looking for trouble. Unlike games of swords and sorcery where the world is filled with magic and monsters, the galaxy of Advent Horizon is filled with super-science and aliens.

These elements serve the same purpose, and the reasons for adventure are often just the same; heroism, exploration, revenge, or simply money. In Advent Horizon, enterprising and heroic adventurers can change the course of history, save entire planets, and uncover ancient secrets or they can be mercenaries with no interest other than getting paid and earning respect. Whether the party is the crew of a ship, a rag tag group of corporate mercenaries, or the detail of an alien ambassador the players still serve a central role in the action.

An Ocean of Stars

While Advent Horizon is built around alien races and adventures in space, your campaign might be limited to a single star system or planet or reach deep into the frontiers of space. The first step in constructing your campaign is to establish the scope.

Galactic. A campaign with this scope is most suited to parties that begin in command of a horizon capable ship. Each adventure will take them to a new world or star system, and random encounters will take place deep in the interstellar void. Galactic settings work best with parties that are all part of the same faction initially and can be directed from on high. Themes of exploration, the unknown, and cooperation will be important given how much the players will be traveling.

At this scope, players will often spend days or weeks aboard their ship. This makes their social interactions, support tasks, crafting, and

other normally down-time activities the center of attention. Having the players all serve as the senior crew of a city sized exploratory vessel is an example of a setting of this scope.

Stellar. When you set the stage of a stellar scope, you are establishing a single star system that sits at the center of attention. Player may or may not possess a ship and will only briefly explore beyond this system on missions that serve their objectives within the central expanse. You'll find that political intrigue, action, and mystery are themes can keep the solar system filled with adventure.

When players have something to be invested in in the system, this scope works best. Perhaps they own a share of the planet or are VP of the local corporate branch. Perhaps an ancient ruin was discovered, and the major factions have split the claim but are all secretly competing against each other.

Planetary. With this scope, you largely limit the players to a single planet. A strictly planetary campaign can feel limiting to players in Advent Horizon without some justification. In most cases the planet and resources on the planet must represent a significant point of focus for the party and their survival. The party could be cyberpunk dissidents on a core world, inciting change. Perhaps they party survived a shipwreck on a world filled with ancient ruins and protogen artifacts.

When fleeing across the galaxy is an option, having a reason to keep the players on a single world is important. This makes for stranding or otherwise tethering the players to the planet.

Coordinates vs. Maps

A good campaign needs an understanding of the positions and locations of all the major locations. Yet, in space everything is moving. Stars and nebulas drift, planets and moons orbit, and everything spins. Normally this motion has no reason to play into an adventure, because any civilization capable of building a horizon drive can calculate the position of most bodies within a few hundred lightyears easily enough. This means that most systems of interest are marked by astral coordinates rather than a specific real position. Astral Coordinates allow a star system or other point of interest to be targeted through the astral network.

Travel Times

To take in to account drift and orbit, the travel times form system to system are subject to a delta based on the distance between the two points.

Worlds Apart

One of the things that sets science fiction games appear from fantasy is the sheer scope - player may well visit dozens or hundreds of alien worlds. Each of these unique locations will sport a unique felling and presence - from gravity and atmosphere, to their sun and moons, not to mention alien life.

As you craft a planet focus on the areas that are relevant to the campaign. Every continent need not be named and mapped, if the areas that the players are going to be exploring are. The same is true of the biome, if any. Focus on the parts relevant to your adventures.

Random Worlds

Using the following tables, you can quickly create a location of interest. These tables assume you are creating a habitable planetary body in a semi stable orbit of the parent star's habitable zone.

Star System

d6	Result
1	Trinary Stars, roll for three stellar types 1d4 Planets
2	Binary Stars, roll stellar type twice 2d4 Planets
3-6	Single Main Star 3d4 Planets

Stellar Category

d10	Result
1	Neutron Star
2	Class O Blue Super Giant
3	Class B Blue Giant
4	Class A Yellow Giant
5	Class F -Yellow White Dwarf
6-7	Class G Yellow Dwarf
8-9	Class K Yellow Dwarf
10	Class M Red Dwarf

Planetary Type

d4	Result
1	Binary Planet with a second sister planet
2	Moon of a larger gas or ice giant
3-4	Standard Terrestrial Planet

THE GAME MASTER

Size and Gravity

d6 Result

- | | |
|-----|---------------------------------|
| 1 | Dwarf planet, Low Gravity |
| 2-5 | Standard planet, Medium Gravity |
| 6 | Large planet, High Gravity |

Atmosphere

d8 Result

- | | |
|-----|---|
| 1 | Toxic. CO2, methane, and cyanogen |
| 2 | Corrosive. Sulfur dioxide, nitrates |
| 3-6 | Breathable. Nitrogen/oxygen composition |
| 7 | Unbreathable. Thin hydrogen oxygen |
| 8 | Exotic. Radium, argon, xenon |

Ecosystem

d8 Result

- | | |
|---|---|
| 1 | Primordial. Organic sludge but no life |
| 2 | Oceanic. Waters teeming with sea life |
| 3 | Mushroom World. Fungi ecosystem |
| 4 | Underworld. All life is subterranean |
| 5 | Jungle Planet. Plants cover the land mass |
| 6 | Ancient. Life once, only ruins remain |
| 7 | Dying world. Deserts and wastelands |
| 8 | Lifeless. A barren cold rock |

Inhabitants

d10 Result

- | | |
|----|--------------------------------------|
| 1 | No intelligent lifeforms |
| 2 | Ship-wreck survivors |
| 3 | Secret pirate outpost |
| 4 | Smuggler's station |
| 5 | Magisterium outpost |
| 6 | Imperium outpost |
| 7 | Corporate outpost |
| 8 | Undiscovered colony |
| 9 | Uncontacted species |
| 10 | Civilization of Intelligent Machines |

Unique Feature

d10 Result

- | | |
|----|---|
| 1 | Protogen ruins crisscross a land mass |
| 2 | Protogen wreckage broadcasting a signal |
| 3 | An out of place artifact |
| 4 | Ruins of a long dead colony |
| 5 | Plants with powerful medical properties |
| 6 | Forests of psionically resonant crystal |
| 7 | A naturally occurring rare material |
| 8 | Strange aurora disrupts electronics |
| 9 | The remnants of a great battle in orbit |
| 10 | A Dyson's Sphere encircles the star |

ADVENTURING

One of the most rewarding and challenging aspects of taking on the role of the game master is crafting mission for the players at your table. Every session they will expect to prepare for, participate in, or complete some adventure for credit, reputation, or experience.

Missions

Missions can range in length from simple encounters like an episode of a television series, or multi-part dramas that play out like a novel. The length and scope of the missions you create is up to you. Each mission will be a mixture of action, exploration, interaction, and drama. The most important part of any mission, whether you are running one printed in a book or one of your own design, is to create a fun experience for your players.

Anatomy of Adventure

Believe it or not there is a kind of formula to a great adventure plot, which you can use to help bring the missions you run with your players to life. Most mission can be broken down into this core structure.

A clear objective

The goal should be outlined at the beginning, players should know what they think they are getting into. During the mission the goal can, and often will, change. That is alright. A simple escort operation may suddenly become a rescue mission after the VIP's are kidnapped by hostile forces. A day off at the beach might suddenly see the players in the center of a counter terrorism op after an attack. However, at each step the players should have a clear idea of what their goals are.



A Present Danger

If missions were not dangerous why would anyone involve people like the players. There needs to be a real danger to the players, even if that danger is not a villain or hostile force. Time, environment, even disease or poison could be the danger that the players are facing and must overcome. Regardless the threat needs to be clear and present.

A sense of Urgency

Missions are time sensitive. There is only so much air in the escape pod the player need to find, or the alien fleet is only a few days away. A sense of pressure and urgency keeps the focus of the adventure on the action and the present, and these will keep players engaged.

Player Agency

The universe is vast and filled powers both great and terrible, but for the purpose of the mission the players must matter. Either they are the only ones with the knowledge, tools, or ability to make a difference, or they are simply the only ones around who can even try. The choices they make, and the consequences of those choices, need to matter to the outcome of the mission, even if that means that the players can fail with disastrous results.

The Twist

Missions should have an element of surprise in them. This can be the sudden revelation that the players are on the wrong side, or it could be a sudden change of pace such as an intercepted communication the shows there is less time than originally thought. At some point in the mission one or two surprises complicate or change the original goal, and for the players to think of new ways to accomplish what there are after.

Resolution

It does not matter if a mission takes one session or one hundred, when things are finally settled, there needs to be resolution. The players either succeeded or failed, and they no reap the rewards or face the consequences. While a mission need not neatly end ever plot aspect, it should resolve the goals laid out in the beginning and the threats faced along the way.

Mission Builder

It is very likely that players will have contacts or connections that can provide them with missions. This is an easy way for you as the game master to throw players in to adventure without much lead up. Rather than spend hours on end hand crafting each mission, you can use the tables below to generate the scaffolding for episodic events. These random missions might not always work out as rolled, it is up to you to turn these outlines into adventures.

Mission Type

This outlines the general category of mission.

D4 Mission Classification

- | | |
|---|----------------|
| 1 | Delivery |
| 2 | Extermination |
| 3 | Reconnaissance |
| 4 | Recovery |

Delivery. This mission involves escorting a person or object to a location, in physical or digital space, and seeing the package safely to the destination.

Extermination. Something many veteran players may be familiar with, an extermination mission usually involves removing a hostile force from a location with force, but not always.

Reconnaissance. These generally involve obtaining information about a person, place, or object. Anything from scouting an enemy fleet to charting an unknown star system. This could also be a mission where the players need to make an inroad or establish a forward base, be that on an unexplored word or developing a contact with a corporation.

Recovery. A mission that asks the player to obtain, investigate, or collect a target from a known or unknown danger. With these missions the players might be asked to save lives in danger do to accident or violence.



THE GAME MASTER

Objective

The objective of the mission lays out the goals and general conditions of success. The Objective is what the players are told their mission is and is the starting point for you to develop.

The threat and twist will radically change the objective, potentially even removing it as the objective entirely.

Delivery

d20 Delivery Objectives

- 1 Drop off a ransom for a kidnapped executive
- 2 Bring a dangerous bio sample to a remote research station
- 3 Escort a conclave of pilgrims to a holy site
- 4 Bring a cache of food to a drought ridden colony
- 5 Deliver a secret communiqué to a powerful general
- 6 Chauffeur a small group of gifted children to a prestigious private school
- 7 Escort a wealthy business owner to his corporate headquarters
- 8 Bring a data chip to a dead drop
- 9 Deliver a rare antiquity to a private collector
- 10 Deliver a letter from a noble to their secret lover
- 11 Bring a crate of medicine to a border station
- 12 Carry a protogen-era tablet to a specialist
- 13 Escort an ancient weapons master to a temple for the martial arts
- 14 Bring an ancient family treasure to the wedding of an heiress
- 15 Deliver a packet of strange papers to a scientist
- 16 Drop off the recipe for a high-test drug to a black market contact
- 17 Escort a murderer to their trial on a nearby moon
- 18 Deliver a map to a forgotten mine to a mercenary tavern
- 19 Drop off a runaway to their family
- 20 Bring classified military documents to a rebellion force

Extermination

d20 Extermination Objectives

- 1 Take out a settlement of rebellious miners
- 2 Remove an alien infestation aboard a valuable derelict ship
- 3 Destroy the evidence of a corporation's involvement in a recent planetary coup
- 4 Hunt down and eliminate a pirate ship that killed a powerful exec's son
- 5 Track and destroy a terrorist cell

- 6 Kill a high profile celebrity
- 7 Eliminate an escaped scientific specimen
- 8 Kill the political rival of a ruler
- 9 Destroy a popular celebrity's reputation
- 10 Destroy the records of a shady transaction
- 11 Remove all evidence pointing to a religious takeover
- 12 Kill the leader of a rising cult
- 13 Kill the ambassador of a new faction
- 14 Take out a ship full of infected refugees
- 15 Hunt down and eliminate a pack of nuisance animals menacing a town
- 16 Destroy a collection of ancient records that detail a vital bloodline
- 17 Remove a document that details a protogen process
- 18 Destroy a manual that teaches cybernetic alteration
- 19 Hunt down a rogue military leader
- 20 Hunt down and kill a notorious bounty hunter

Reconnaissance

d20 Reconnaissance Objectives

- 1 Deploy sensor probs around an unusually active star.
- 2 Perform a detailed scan of a strange interstellar asteroid.
- 3 Scout a newly discovered protogen site in the system.
- 4 Secure an ancient compound recently discovered on an unclaimed planet.
- 5 Set up a location beacon inside a dangerous asteroid belt.
- 6 Reactivate a security station on the border of a hostile faction's space.
- 7 Make contact with a disenfranchised political leader in the colonies.
- 8 Investigate a derelict vessel that has been spotted in the system.
- 9 Meet with the delegate of an alien race that has been otherwise hostile to other civilizations
- 10 Infiltrate a cult that has been causing issues for the corporations.
- 11 Plant a computer virus in the network of a powerful corporation.
- 12 Mediate a cease-fire between two warring factions on a valuable colonial world.
- 13 Investigate a distress signal emanating from an uninhabited planet or moon.
- 14 Find out why a decorated military commander has gone AWOL.
- 15 Locate the base of a notorious band of slavers.

- 16 Get recording of a powerful politician's shady dealings.
- 17 Find the resting place of an ancient hero.
- 18 Chart a course through a dangerous nebula to a resource rich rogue moon.
- 19 Find a legendary lost city.
- 20 Investigate a region of space where multiple ships have gone missing.

Recovery

d20 Recovery Objectives

- 1 Retrieve the computer core of a derelict station in a dangerous region of space.
- 2 Track and apprehend a dangerous fugitive.
- 3 Locate a missing person for a local plutocrat.
- 4 Retrieve a cargo shipment lost to a notorious band of pirates.
- 5 Apprehend a notorious pirate who has mysteriously gone into hiding.
- 6 One of the party's contacts has been kidnapped.
- 7 Retrieve a runaway heir to an aristocratic family.
- 8 Locate several donor organs that have gone missing.
- 9 Retrieve a document detailing the war crimes of a political leader.
- 10 Apprehend a caravan of runaway slaves.
- 11 Track down the leader of a new cult.
- 12 Rescue the mistress of a powerful leader from an ongoing natural disaster.
- 13 Track down and capture an escaped scientific specimen.
- 14 Retrieve an artifact from a primitive culture.
- 15 Locate a map detailing the location of an ancient space base.
- 16 Retrieve a ledger of valuable business transactions.
- 17 Collect samples of an alien organism from a quarantine.
- 18 Retrieve Patient Zero of an epidemic outbreak.
- 19 Track down an escaped criminal who was framed for his crimes.
- 20 Recover a notorious pirate's haul from deep space.



Threat

This is a minor encounter set on preventing the players from succeeding. This threat could be directly responsible for the risk to the objective, or simply an obstacle.

The threat the party faces should keep them on their toes, but this does not need to be a combat encounter; the players may well overcome these antagonists with out violence, that is up to you.

Threats

d20 Mission Threats

- 1 A band of cultists.
- 2 Several low-level mercenaries.
- 3 A dangerous pack of alien animals.
- 4 A cybernetically augmented soldier being controlled by a shadowy force.
- 5 Several low-level pirates.
- 6 A hoard of Mycelial Revenants.
- 7 A crew of deranged ship wreck survivors.
- 8 A single extremely dangerous alien predator.
- 9 An assassin targeting one of the party members.
- 10 A misfit armed with a powerful and dangerous Protogen Artifact.
- 11 A conniving and manipulative aristocrat.
- 12 A gang of hired thugs.
- 13 A deranged AI and several automated attack drones.
- 14 A corporate exec and his guards.
- 15 A rogue government agent with a personal agenda.
- 16 An elite hacker obsessed with one or all of the party.
- 17 A dangerous cult fanatic.
- 18 A gang of criminals in the middle of a heist.
- 19 A mind-controlling alien parasite.
- 20 An insane psionic.

Twist

Nothing ever goes as planned. The mission twist is the point where the adventure takes an unexpected turn. This could be a new threat or objective, or simply something so unexpected that it interferes with the players' plans.

Twists

d20 Mission Twist

- 1 A massive solar flare is sweeping system
- 2 The party is mistaken for a group of dangerous violent criminals.
- 3 The initial client set the team up to fail, the mission is a trap.
- 4 The party's actions have fulfilled some cult's prophecy and are now being worshiped and messiahs.
- 5 A pirate ship arrives intent on stealing the player's valuable loot.
- 6 The threat is a Major Encounter.
- 7 A hostile alien monster attack interrupts the mission.
- 8 A temporal anomaly has caused the party to experience months of time debt.
- 9 The threat turns out to have a morally superior reason for their actions.
- 10 The events turn out to be part of an ultra-immersion reality holovid broadcast.
- 11 Communications fail as a powerful EM storm enters the area.
- 12 One of the party members has received a secret mission to ensure the party fails.
- 13 The party is exposed to a lethal alien pathogen.
- 14 The party discovers a group of cryogenically frozen 22nd century earth colonists.
- 15 The party uncover an illegal corporate laboratory.
- 16 The party's actions lead them to stumble upon a terrorist plot.
- 17 A heavily armed team has been hired by the competition to complete the mission first.
- 18 The party is actually in a hyper realistic simulator and need to escape.
- 19 An artifact is discovered during the mission with serious implications.
- 20 One or two of the party members are exposed to powerful psychotropics and begin to hallucinate vividly.

ENCOUNTERS

The moments of contest and conflict in an adventure are known as encounters. This might be a bar brawl or space battle, or a tense negotiation or game of wits. While not all conflict is combat, all encounters are conflict.

Using Encounters

Regardless of its place in the adventure, these events are either Minor Encounters or Major Encounters. A Minor encounter might be several guards that need to be subdued, or an aggressive alien animal. On the other hand, a Major Encounter could be facing down a battleship or trying to beat an ancient mind at a game of strategy.

Conflicts and obstacles are at the heart of every great adventure, remember that while your adventures don't need to be back to back gunfights, some kinds of conflict and resolution are essential to keep the action up and players engaged.

Minor Encounter. When players are faced with a challenge that is relatively easy to overcome, it's a Minor Encounter. Most parties can overcome four to six minor encounters between long rests. This would significantly deplete their abilities, ammunition, and healing capability.

Major Encounter. Facing threats that are almost certainly lethal to one or members of the party, or ensuring the destruction and depletion of their resources, major encounters should be used sparingly. When using a Major encounter, keep in mind that this should be a penultimate conflict, as it will be particularly hard on the party.

Challenge Rating

Encounters and objectives can have multiple degrees of difficulty, called a challenge rating. An encounter's difficulty is determined by comparing the total level of the party against the challenge rating. A Minor Encounter has a challenge rating of 1/8th party's total level, and a Major Encounter has a challenge rating of 1/4th the party's total level. For example, a challenge rating 2 encounter poses a significant threat to a party of four characters with an average level of 2, even though the numbers are in the party's favor. In that same encounter a party of four level 6 characters would easily overcome the challenge.

Challenge rating of the encounter also sets the amount of experience points (XP) the party would receive for defeating or overcoming that encounter, be it through combat or cunning.

NON-PLAYER CHARACTERS

Challenge Rating	XP Award	Major Level	Minor Level
1/8	25	–	1
1/4	50	1	2
1/2	100	2	4
1	200	4	8
2	450	8	16
3	700	12	24
4	1,100	16	32
5	1,800	20	40
6	2,300	24	48
7	2,900	28	56
8	3,900	32	64
9	5,000	36	72
10	5,900	40	80
11	7,200	44	88
12	8,400	48	96
13	10,000	52	104
14	11,500	56	112
15	13,000	60	120
16	15,000	64	–
17	18,000	68	–
18	20,000	72	–
19	22,000	76	–
20	25,000	80	–
21	33,000	84	–
22	41,000	88	–
23	50,000	92	–
24	62,000	96	–
25	75,000	100	–
26	90,000	104	–
27	105,000	108	–
28	120,000	112	–
29	135,000	116	–
30	155,000	120	–

The guards at a spaceport dock, the sleezy information broker holding out for a deal on critical intel, the imposing Capitol Ship commander relentlessly hunting the party; any character that you control who is not also or otherwise controlled by a player is a Non-Player Character.

You will populate your setting with a diverse cast of NPCs as players develop allies and enemies. Most of these characters do not need any kind of detailed story or history, nor do they require a stat block or description of abilities. These so-called Quick NPCs tend to be unimportant to the game; shop clerks, boarder agents, maintenance techs, and so on.

Other times you will want to generate a character with a more developed story and history. These Detailed NPCs should have more than a name and title, they should have some distinct personality. The most common Detailed NPCs that players will encounter is the Contacts that they develop. As NPCs the role of playing these characters falls to you as Game Master.

Creating Non-Player Characters

The detailed NPCs you create should be interesting and purpose built. You can sum up most of these NPCs with a few key pieces of information:

- Abilities
- Affiliation
- Appearance
- Profession
- Quarks
- Trait

Abilities

Unless this NPC is forced to take on adventuring or get into contests regularly, don't generate ability scores. All you really need to know is where they excel, and where they are weakest. This can help define their personality as well. An NPC with a high strength and low wisdom might be a block head type, while an NPC with high intelligence and low charisma could be an insufferable bore. Pick one high ability score, and one low ability score for the NPC, or simply roll a d6 for each.

If their action statistics are important, consider using one of the NPC templates below as a starting point.

THE GAME MASTER

Affiliation

Most NPCs you create will be affiliated with some social structure. This goes double for contacts that you create for your players. Affiliation tells you the kind of world the NPC lives in. An NPC with military affiliation might be soldier or be a civilian defense industry employee, a criminal affiliated NPC could be a street hustler, or con-man.

NPC Affiliation

d6	Primary Affiliates
1	Black Market
2	Corporate
3	Criminal
4	Government
5	Military
6	Underworld

Appearance

Giving your NPCs a unique visible trait helps in describing them to the players and building their unique story. Rather than being just an Ixaxian, your NPC could be that Ixaxian with the bright yellow stripes. Whatever your choice to embellish their appearance make it memorable and distinct so your players have something to latch on to and visualize.

Profession

What the NPC does is as much a part of their affiliation as it is their utility. Select one of the professions for your NPC from those in section 5. If they are a contact of the players, select a contact role that matches their affiliation. If you expect combat you can choose one of the stat blocks, below.

Quarks

What sets the NPC apart from the crowd? A quark for an NPC can be any number of things from physical characteristic to mental illness or unique social positions. You can come up with any quark you please, or you can roll on the following table.

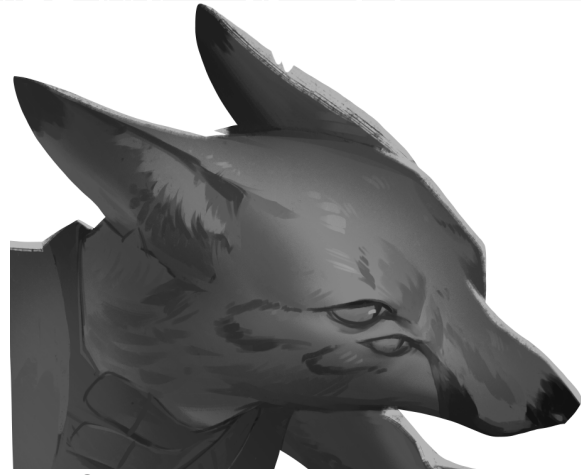

NPC Quarks

d8	Quark or characteristic
1	Antipathy score of 6+1d8
2	Believes they are the player's bestie
3	Complete Coward
4	Extremely wealthy (+40 credit)
5	Missing an eye, a limb, or other
6	Mute, communicates in sign
7	Wanted for a serious crime
8	Well Known (+15 Reputation)

Traits

Finally, what aspect of the NPC is impressive. This could be a hidden talent or the sources of their utility to the players. Regardless this should be something that sets them apart significantly from the average person in a crowd. After all, if you are creating details for this person, they need to be important. Most often this is several proficiencies, a level in an adventuring class, or some other advantage such as augmentation.

Don't randomly select these, choose something that specifically fills the need that you have in your adventure and campaign. However, here are some examples of the kinds of traits these important people can have.

- +30 Reputation
- +70 Credit
- 1d4 Cybernetic upgrades
- Four Proficiency slots
- Level 3 Connection to an Organization
- One psionic Proficiency

Finishing Touches

How your NPC behaves can be defined by an Axis Alignment. Select one that matches how you want them to behave. For additional history you could select an Event in Section 5 to flesh out their history further.

NPC Templates

This selection of general NPCs can be used when your players encounter NPCs during your campaign. Because these are generalized, there are several ways you can alter them to suit the needs of your campaign.

Altering NPCs

It is relatively easy to modify the templates below.

Species Traits. The templates below do not have any racial abilities. You could easily add the racial traits of any of the races in Section 3. Adding racial traits will generally increase the abilities of the template, adding 1/2 a challenge rating point to the Challenge Rating.

Armor. Upgrading the armor of the template can have a noticeable effect. Each point of AC added from the armor is 1/8 a challenge rating increase.

Weapons. Adding weapons or removing weapons drastically alters the NPC's combat ability. Each dice of damage of a weapon added or removed accounts for 1/4 of a challenge rating point.

Cybernetics. Cybernetic weapons and armor will affect the challenge rating of the NPC as noted under weapons and armor. Simply having cybernetics increases the NPC's challenge rating by a 1/8 point.

Psionics. Each Psionic proficiency increases the challenge rating of the NPC by 1/2 a point.

Feats. An NPC could easily have any feats for skills they are proficient in. Such feats should add 1/4 challenge to the NPC.

Ships. The Challenge rating of a crewed ship is based on her command compliment, +2 for light ships, +6 for medium ships, +10 for heavy ships, and +18 for capitol ships.

Ambassador

Reasonable or Zen Alignment
Armor Class 11 (graphene fiber coat)
Armor Rank 13 (+2)
Hit Points 9 (2d8)
Size medium
Speed 10m

STR	DEX	CON	INT	WIS	CHA
10 (+0)	10 (+0)	10 (+0)	12 (+1)	15 (+2)	15 (+2)

Saving Throws Wis +4, Cha +2

Skills Bureaucracy +1, Insight +4, Deception +4, Persuasion +4

Senses passive Perception 12

Languages any four languages

Challenge 1/2 (100 XP)

Actions

Light Laser Pistol. Ranged weapon attack: +2 to hit, 10/40m one target. Hit: 8 (1d8) thermal damage.

Dazzle. Target must succeed a DC 14 Wisdom saving throw or receive Disadvantage on attack rolls, ability checks, skill checks, and saving throws until the end of the Ambassador's next turn.

Ambassadors are dignitaries and diplomats that can often be found where there is an intersection of business and politics. It is rare to find an ambassador alone, as they usually travel with a retinue of guards, attachés and assistants.

Aristocrat

Passionate or Impulsive Alignment
Armor Class 11 (graphene fiber coat)
Armor Rank 13 (+2)
Hit Points 4 (1d8)
Size Medium
Speed 10m

STR	DEX	CON	INT	WIS	CHA
10 (+0)	10 (+0)	10 (+0)	12 (+1)	10 (+0)	14 (+2)

Saving Throws Int +1, Cha +2

Skills Performance +2, Investigation +1, History +1

Senses passive Perception 10

Languages any three

Challenge 1/4 (50 XP)

Actions

Rapier. Melee Weapon Attack: +2 to hit, one target. Hit: 4 (1d8) piercing damage.

Assassin

Methodical or Analytical Alignment
Armor Class 14 (light ballistic vest)
Armor Rank 17 (+4)
Hit Points 78 (12d8 +24)
Size Medium
Speed 10m

STR	DEX	CON	INT	WIS	CHA
11 (+0)	16 (+3)	14 (+2)	13 (+1)	11 (+0)	10 (+0)

Saving Throw: Dex +3, Con+2

Skills Acrobatics +6, Deception +3, Perception +3, Stealth +9

Senses Passive Perception 13

Languages any three

THE GAME MASTER

Challenge 5 (1,800 XP)

Assassinate. During its first turn, the assassin has advantage on attack rolls against any creature that hasn't taken a turn. Any hit the assassin scores against a surprised creature is a critical hit.

Evasion. If the assassin is subjected to an effect that allows it to make a Dexterity saving throw to take only half damage, the assassin instead takes no damage if it succeeds on the saving throw, and only half damage if it fails.

Sniper. The assassin's weapon long range is doubled. If the Assassin has advantage on a ranged attack, they may add 9 (2d8) damage on a hit once per turn, up to four times. These uses recharge after a long or short rest.

Actions

HI Laser Rifle. +8 to hit, one target. Range 300m/1800m Hit: 16 (3d8) thermal

Trained to kill people from a distance, Assassins are remorseless killers who work for Aristocrats, Ambassadors, Business Executives, and anyone else who can meet their price.

Business Executive

Methodical or Analytical Alignment

Armor Class 13 (graphene fiber coat)

Armor Rank 15 (+2)

Hit Points 9 (2d8)

Size Medium

Speed 10m

STR	DEX	CON	INT	WIS	CHA
11 (+0)	14 (+2)	11 (+0)	12 (+1)	14 (+1)	16 (+3)

Skills Insight +2, bureaucracy +3, Performance +5, Persuasion +5

Senses passive Perception 11

Languages any three languages

Challenge 1/2 (100 XP)

Actions

Stun Gun. Melee Weapon Attack: +2 to hit, reach 2m, one creature. Hit: 5 (2d4) electrical damage. **Stun:** succeed a DC 13 Constitution saving throw or be stunned until the end of their next turn.

Found anywhere in the Arc, Business Executives bring vision and experience to the business they work for. The rich are never far from their shields, Business Executives are known to hire body and security guards to help keep themselves safe.

Citizen

Any Alignment

Armor Class 10 (None)

Armor Rank 0

Hit Points 3 (1d6)

Size Medium

Speed 10m

STR	DEX	CON	INT	WIS	CHA
10 (+0)	10 (+0)	10 (+0)	10 (+0)	10 (+0)	10 (+0)

Senses Passive Perception 10

Languages any one

Challenge 0 (10 XP)

Actions

Punch. Melee Weapon Attack: +0 to hit, reach 2m, one target, Hit: 1 (1d4) bludgeoning damage

A standard citizen of the Arc usually found working everyday careers in technology, services, and manufacturing. While ordinary these individuals live complex lives full of trials and challenges just like you.

Commander

Methodical or Reasonable Alignment

Armor Class 19 (Graphene Combat Mail)

Armor Rank 24 (+6)

Hit Points 52 (8d8 +16)

Size Medium

Speed 10m

STR	DEX	CON	INT	WIS	CHA
11 (+0)	16 (+3)	14 (+2)	11 (+0)	11 (+0)	15 (+2)

Saving Throws Con +4, Cha +4

Skills Weapon Systems, +3, Wilderness +2, Insight +1, Perception +2,

Senses Passive Perception 12

Languages any three languages

Challenge 3 (700 XP)

Actions

Leadership (Recharges after a Short or Long Rest). For 1 minute, the Commander can utter a special command or warning whenever a nonhostile creature that it can see within 5 meters of it makes an attack roll or a saving throw. The creature can add a d4 to its roll provided it can hear and understand the Commander. A creature can benefit from only one Leadership die at a time. This effect ends if the Commander is incapacitated.

Multiattack. The Commander makes two ranged attacks.

Laser Carbine. +5 to hit, range 100/300m, one target Hit: 8 (4d4) Thermal damage

Commanders lead soldiers into battle against the enemies of their faction. When they aren't relaying orders, they are a force to be reckoned with on the battlefield.

Cult Zealot

Passionate or Zealous Alignment

Armor Class 14 (armored coat)

Armor Rank 16 (+1)

Hit Points 33 (6d8 + 6)

Size Medium

Speed 10

STR	DEX	CON	INT	WIS	CHA
11 (+0)	14 (+2)	12 (+1)	10 (+0)	13 (+1)	14 (+2)

Skills Intuition +5, Deception +4, Persuasion +4

Senses passive perception 11

Languages any one language

Challenge 3 (700 XP)

Devotion. The Cult Zealot has Advantage on saving throws against anxiety or being frightened.

Armor of the faithful. Zealots add their Wisdom modifier to their Armor Class.

Actions

Ceremonial Dagger. Melee Weapon Attack +2 to hit, reach 2m, one creature Hit: 8 (1d4 slashing +1d10 thermal) damage

Uncanny Aim (Recharges on a 5 or 6). The Zealot gains advantage on attack rolls against non-believers until the end of its next turn.

Zealots exist in all parts of cults, some are devout members who lack the skill to progress, others help call the shots and bring their vision of the cult to fruition. The most dangerous are the zealots of destroyed cults, with nothing to lose they will fight till the death and aren't afraid to take others with them.

Cultist

Passive or Zealous Alignment

Armor Class 10

Armor Rank 0

Hit Points 4 (1d8)

Size Medium

Speed 10m

STR	DEX	CON	INT	WIS	CHA
12 (+1)	11 (+0)	10 (+0)	10 (+0)	11 (+0)	12 (+1)

Skills Deception +2, Persuasion +1

Senses Passive Perception 10

Languages any one language

Challenge 1/8 (25 XP)

Devotion. The Cultist has Advantage on saving throws against anxiety or being frightened.

Actions

Hatchet. Melee Weapon Attack +3 to hit, reach 1m, one creature Hit: 4 (1d6+1)

Those who know the hidden truth, the hidden who fight a shadow government, or even members of a shadow government. People join cults to try to fill something missing in their life, most are victims to very charismatic people who want to use them. None of that really matters when they come at you with a hatchet though.

Elite Body Guard

Analytical or Reasonable Alignment

Armor Class 14 (Light Ballistic Vest)

Armor Rank 18 (+4)

Hit Points 112 (15d8+45)

Size Medium

Speed 10m

STR	DEX	CON	INT	WIS	CHA
18 (+4)	16 (+3)	16 (+3)	10 (+0)	11 (+0)	12 (+1)

Saving Throws Str +7, Dex +5, Con +6

Skills Intimidation +5, Piloting +8, Endurance +8

Senses Passive Perception 12, Darkvision 10m (goggles)

Languages any two

Challenge 6 (2,300)

Brave. The Body Guard has advantage on saving throws against being charmed or frightened.

Cover. The Body Guard can target an ally within 2 meters of itself and give that target +2 AC, if the ally gets hit with an attack the bodyguard takes the damage.

Actions

Multiattack. The Body Guard makes two melee attacks ranged attacks.

Thermal Saber. melee weapon attack +7 to hit, one target. Hit: 14 (1d8 slashing, +1d10 thermal)

Ion Pistol. ranged weapon attack +6 to hit, one target, Range 10m/30m, Hit: 8 (2d6) electrical

Body Guards are individual guards for people of moderate wealth, while Business Executives might have a security team, an ambassador traveling with a bodyguard has a much higher chance of survival.

Infantry Grunt

Methodical or Passive Alignment

Armor Class 17 (Ballistic Carrier Vest)

Armor Rank 21 (+6)

Hit Points 32 (4d8+8)

Size Medium

Speed 10m

STR	DEX	CON	INT	WIS	CHA
14 (+2)	12 (+1)	14 (+2)	10 (+0)	11 (+0)	10 (+0)

Saving Throws Str +2, Con +2,

Skills Athletics +4, Endurance +4

Senses Passive Perception 10

Languages any two languages

Challenge 1 (250 XP)

Actions

7.62 Automatic Rifle. Ranged weapon attack +5 to hit, range 100m/300m, one creature Hit: 15 (4d6) Impact.

The stories from the old wars sounded distant, impersonal, with people killing others in front of a screen. Fighting in space required combat to be personal again. Infantry Grunts can be found anywhere there is combat, refreshments, or relaxation.

Pirate Commander

Passionate or Impulsive Alignment

Armor Class 15 (armored coat)

Armor Rank 17 (+2)

Hit Points 70 (10d8 +20)

Size Medium

Speed 10m

STR	DEX	CON	INT	WIS	CHA
15 (+2)	16 (+3)	14 (+2)	14 (+2)	11 (+0)	14 (+2)

Saving Throws Str +4, Dex +5, Wis +2

Skills Acrobatics +2, Pilot +4, Wp Systems +4

Senses Passive Perception 10

Languages any two languages

Challenge 3 (700 XP)

Actions

Multiattack. Pirate Commander make two ranged or melee attacks.

Thermal Saber. melee weapon attack +7 to hit, one target. Hit: 14 (1d8 slashing, +1d10 thermal)

The stories from the old wars sounded distant, impersonal, with people killing others in front of a screen. Fighting in space required combat to be personal again. Infantry Grunts can be found anywhere there is combat, refreshments, or relaxation.

Primitive

Passionate or Impulsive Alignment

Armor Class 13 (Worked Leather)

Armor Rank 0

Hit Points 12 (2d8+3)

Size Medium

Speed 10m

STR	DEX	CON	INT	WIS	CHA
16 (+3)	13 (+1)	17 (+3)	9 (-1)	11 (+0)	9 (-1)

Skills Wilderness +2, Survival +5

Senses Passive Perception 10

Languages any one language

Challenge 1 (200 XP)

Seeing Red. At the start of its turn, the Primitive can gain advantage on all melee weapon attack rolls during that turn, but attack rolls against it have advantage until the start of its next turn.

Actions

Axe. Melee weapon attack, +5 to hit, reach 1m, one target. Hit: 8 (1d10+3 Versatile) slashing damage

Refusing to adapt to the changing ways Primitives believe that life was better before we went to the stars. Primitives can be found on any planet but rarely in space, except when brought against their will.

Security Guard

Analytical or Reasonable Alignment

Armor Class 14 (Light Ballistic Vest)

Armor Rank 18 (+4)

Hit Points 12 (2d8+2)

Size Medium

Speed 10m

STR	DEX	CON	INT	WIS	CHA
13 (+1)	13 (+1)	13 (+1)	10 (+0)	11 (+0)	10 (+0)

Saving Throws Dex +1, Con +1

Skills Perception +2

Senses Passive Perception 12

Languages any one language

Challenge 1/8 (25 XP)

Actions

Shock Baton, Melee Weapon Attack, +3 to hit, reach 5ft, one target. Hit. 4 (1d6+1) bludgeoning damage and 4 (1d8) electrical damage. Stunning: On a hit, DC 15 Constitution saving throw or be stunned until the end of their next turn.

Spy

Methodical or Zen Alignment
Armor Class 13 (Graphene Fiber Coat)
Armor Rank 15 (+2)
Hit Points 16 (3d8+3)
Size Medium
Speed 10m

STR	DEX	CON	INT	WIS	CHA
11 (+0)	14 (+2)	12 (+1)	11 (+0)	13 (+1)	11 (+0)

Skills Perception +5, Stealth +6, Survival +5

Senses passive perception 15

Languages any three languages

Challenge 1/2 (100 XP)

Keen hearing and Sight. The Spy has advantage on Wisdom (Perception) checks that rely on hearing or sight.

Actions

Multiattack. The spy makes two melee attacks or two ranged attacks.

Stun Knuckles. Melee Weapon Attack, +4 to hit, reach 2m, one target. Hit: 9 (1d4 bludgeoning, +2d4 electrical). Stunning: On a hit, DC 15 Constitution saving throw or be stunned until the end of their next turn.

Light Laser Pistol. Ranged weapon attack. +4 to hit, ranged 10m/40m, one target. Hit: 5 (1d8+1) Thermal

Spies exist in multiple types of work, Corporate Espionage, gathering information on your rivals, spreading disinformation about a competitor. Ever since there were three people one person would talk about the other one. Spies can be found anywhere where there is important information.

Street Thug

Passive or Impulsive Alignment
Armor Class 11 (armored coat)
Armor Rank 13 (+1)
Hit Points 25 (4d6 +10)
Size Medium
Speed 10m

STR	DEX	CON	INT	WIS	CHA
15 (+2)	11 (+0)	14 (+2)	10 (+0)	10 (+0)	11 (+0)

Skills Intimidation +2

Senses passive Perception 10

Languages Any one language

Challenge 1/2 (100 XP)

Pack Fighting. The street thug has advantage on an attack roll against a creature if at least one of the thug's allies is within 2 meters of the

creature and the ally isn't incapacitated.

Actions

Bat. Melee Weapon Attack: +4 to hit, reach 2m, one creature. Hit: 5 (1d6+2) bludgeoning damage

.22 Light Auto Pistol. Ranged Weapon Attack, +2 to hit, range 10m/20m, one target. Hit 18, (5d4 burst) impact damage.

Where there is illicit money to be made, the dregs of society are there to earn a dime. Street thugs are enforcers of their turf and are skilled at intimidation. You can never trust them, even after you've paid your dues.

Veteran Soldier

Analytical or Zen Alignment
Armor Class 17 (Light Exo-Suit)
Armor Rank 21 (+4)
Hit Points 58 (9d8+18)
Size Medium
Speed 10m

STR	DEX	CON	INT	WIS	CHA
16 (+3)	14 (+2)	14 (+2)	10 (+0)	11 (+0)	10 (+0)

Skills Athletics +5, Perception +2

Senses Passive Perception 12, Darkvision 10m (goggles)

Languages Any two languages

Challenge 5 (1,800 XP)

Coordinated Attack. Select a target and make a normal attack. On a hit, all allies within 20 meters receive Advantage on attack rolls against that target until the beginning of the next turn.

Environmental Armor. The Veteran Soldier is immune to gasses, vacuums, and has resistance to radiation.

Actions

Multiattack The Veteran Soldier makes two melee or ranged weapon attacks.

7.62 Automatic Rifle. Ranged weapon attack +5 to hit, range 100m/300m, one creature Hit: 15 (4d6) Impact. Threat: adjacent creatures must make a DC 14 Dexterity saving throw or take 8 (2d6) impact damage.

Chain-Knife. Melee Weapon Attack +5 to hit, reach 2m, one target. Hit 7 (2d4 +3) slashing damage

APPENDIX A: HAZARDS

CONDITIONS

Conditions are situational modifiers to a creature's general capabilities. Most conditions provide some significant detriment. In a few cases, such as being provoked, there may be some advantages to the condition as well.

A condition lasts until it is countered (the prone condition is countered by standing up, for example) or for a duration specified by the effect that imposed the condition.

If multiple effects impose the same condition on a creature, each instance of the condition has its own duration, but the condition's effects don't get worse, except for exhaustion. A creature either has a condition or doesn't.

The following definitions specify what happens to a creature while it is subjected to a condition.

Anxiety

- An Anxious creature's proficiency bonus is halved.
- Wisdom and Intelligence saving throws are made with Disadvantage.

Blinded

- A blinded creature can't see and automatically fails any ability check that requires sight.
- Attack rolls against the creature have advantage, and the creature's attack rolls have disadvantage.

Charmed

- A charmed creature can't attack the charmer or target the charmer with harmful abilities or actions.
- The charmer has advantage on any ability check to interact socially with the creature.

Deafened

- A deafened creature can't hear and automatically fails any ability check that requires hearing.

Exhaustion

Some special abilities and environmental hazards, such as starvation and the long-term effects of freezing or scorching temperatures, can lead to a special condition called exhaustion. Exhaustion is measured in six levels. An effect can give a creature one or more levels of exhaustion, as specified in the effect's description.

Level	Effect
1	Lose Proficiency bonus
2	Speed halved
3	Disadvantage on skills, attack rolls and saving throws
4	Hit point maximum halved
5	Speed reduced to 0
6	Death

If an already exhausted creature suffers another effect that causes exhaustion, its current level of exhaustion increases by the amount specified in the effect's description.

A creature suffers the effect of its current level of exhaustion as well as all lower levels. For example, a creature suffering level 2 exhaustion has its speed halved and has disadvantage on ability checks.

An effect that removes exhaustion reduces its level as specified in the effect's description, with all exhaustion effects ending if a creature's exhaustion level is reduced below 1.

Finishing a long rest reduces a creature's exhaustion level by 1, provided that the creature has also ingested some food and drink.

Frightened

- A frightened creature has disadvantage on ability checks and attack rolls while the source of its fear is within line of sight.
- The creature can't willingly move closer to the source of its fear.

Grappled

- A grappled creature's speed becomes 0, and it can't benefit from any bonus to its speed.
- The condition ends if the grappler is incapacitated (see the condition).
- The condition also ends if an effect removes the grappled creature from the reach of the grappler or grappling effect, such as when a creature is hurled away by an explosion.

Incapacitated

- An incapacitated creature can't take actions or reactions.

Paralyzed

- A paralyzed creature is incapacitated (see the condition) and can't move or speak.

- The creature automatically fails Strength and Dexterity saving throws. Attack rolls against the creature have advantage.
- Any attack that hits the creature is a critical hit if the attacker is within 2 meters of the creature.

Poisoned

- A poisoned creature has disadvantage on attack rolls and ability checks.

Prone

- A prone creature's only movement option is to crawl, unless it stands up and thereby ends the condition.
- The creature has disadvantage on attack rolls.
- An attack roll against the creature has advantage if the attacker is within 2 meters of the creature. Otherwise, the attack roll has disadvantage.

Provoked

- A creature that is provoked has disadvantage on skill rolls and attack rolls.
- Being provoked, a creature has Advantage on attacks and actions targeting their provoker.

Restrained

- A restrained creature's speed becomes 0, and it can't benefit from any bonus to its speed.
- Attack rolls against the creature have advantage, and the creature's attack rolls have disadvantage.
- The creature has disadvantage on Dexterity saving throws.

Septicemia

- Become poisoned until the disease is cured.
- Every 24 hours that elapse, the creature must repeat the triggering saving throw (Or a DC 15 Constitution saving throw) reducing its hit point maximum by 5 (1d10) on a failure.
- The target dies if the disease reduces its hit point maximum to 0. This reduction to the target's hit point maximum lasts until the disease is cured.

Shock

- Creatures in Shock lose the ability to interface with the situation, become delirious and can even be delusional.
- Cannot take actions or reactions besides Disengage and Hide.
- Cannot use skills or feats.

Stunned

- A stunned creature is incapacitated (see the condition), can't move, and can speak only falteringly.
- The creature automatically fails Strength and Dexterity saving throws.

- Attack rolls against the creature have advantage.

Unconscious

- An unconscious creature is incapacitated (see the condition), can't move or speak, and is unaware of its surroundings
- The creature drops whatever it's holding and falls prone.
- The creature automatically fails Strength and Dexterity saving throws.
- Attack rolls against the creature have advantage.
- Any attack that hits the creature is a critical hit if the attacker is within 2 meters of the creature.

RADIATION

One of the greatest environmental threats in space is radiation. Cosmic rays, plasma bursts, x-rays from ancient stars, and nuclear reactors all produce ionizing radiation. Exposure to ionizing radiation can cause some minor damage, but the real threat is contracting Radiation Sickness. Significant radiation exposure breaks down cell structures and causes them to fail. You never naturally recover from Radiation Sickness; without aggressive medical treatment you will eventually die. There are three categories of Radiation Sickness, linked on the level of exposure.



Levels of Exposure

Casual Exposure

This is the kind of exposure that would come from spending a lot of time in an area with moderate levels of radiation, or a short time in an area of high radiation (less than one hour). Handling depleted Uranium for brief periods

HAZARDS

can cause Category One Radiation Sickness. Symptoms will appear within 1d12 months of exposure.

Symptoms: Constant headaches, mild nausea, small skin irritations, has trouble recovering from infections.

Penalties: Reduce maximum hit points by one third, each month after onset you take 1 point of Constitution damage. When your Constitution score has been reduced to half, your movement speed is reduced by 3 meters. At this point you can no longer recover hit points naturally. You have disadvantage on Death saving throws. When your Constitution score is reduced to 3, you die.

Direct Exposure

Being in direct contact with high volumes of depleted radioactive matter, small volumes of highly unstable matter, or spending more than an hour in fallout areas. A near hit from a nuclear or antimatter explosive, an hour of being in inside the core room of a nuclear power plant will cause Category Two sickness. Symptoms will appear within 1d10 days of exposure.

Symptoms: Constant body and head pains, nausea, blotching and hair loss. Has trouble recovering from infections and healing, trouble keeping food down.

Penalties: You can no longer heal naturally from injuries or illness and will not recover hit points. Your maximum hit points are reduced by half. Each day you suffer 1 point of Constitution damage. When your Constitution score is reduced to half, you suffer 3 levels of fatigue. When Your Constitution reaches 3, you die.

Lethal Exposure

A direct hit from a neutron star's x-ray burst, a near hit from a Neutron weapon, holding on to a piece of highly unstable matter, breathing in radioactive dust, and skinny-dipping in a nuclear plant coolant tank are examples of lethal radiation exposure, and will cause Category 3 Radiation Sickness. Symptoms will appear within 1d12 hours of exposure.

Symptoms: Violent bloody vomiting, bleeding from the eyes, noise, ears and multiple pus-filled skin lesions, hair loss and epidermal peeling. Violent mini-maul seizures accompany bouts of racking agony and hemorrhaging. Cannot heal or fight off infection or poisons.

Penalties: Suffer 4 levels of Exhaustion. Reduce strength, dexterity, constitution, and charisma by half, and each hour reduce Constitution score by 1. Cannot recover HPs or save against death. Hopefully the character will not even be conscious. When Constitution score is reduced to 0, the you die.

Treatment and Recovery

Casual Exposure can be treated with a common injection of Nanoiodine, which will eliminate symptoms in a few weeks. Treatment for more serious exposure requires a successful Medicine (genetics) check against a DC of 15 + 5 per level of radiation sickness. A medical bay or specialized treatment and drug kit is required.

So long as you receive treatment before you lose half your constitution score, you will recover fully in 3d6 days per category. However, if the Radiation Sickness is left unchecked it will kill.

ANTIPATHY

Antipathy is a **disability** score that represents a character's mental health, or more accurately, mental damage. In a sense Antipathy is something like an insanity score. The higher an antipathy, the more mentally unbalanced a character and the more (or more severe) Issues they have developed.

Using Antipathy

Under normal circumstance, characters start with an Antipathy of 0; however, there are horrific things out there that will cause a character to gain antipathy; trauma, artifacts, even some powers will cause the character to gain antipathy. Meditation, therapy, and a strong will can resist or even reduce Antipathy and cure some issues.

Gaining Antipathy

Characters gain antipathy one point at a time, and it is ranked 1 to 30 like all player Ability Scores. Each time a character gains 5 points of Antipathy one minor issue develops, or one of their issues elevates from minor to major, or major to acute. Antipathy is rarely gained willingly, and will be assigned by the GM when it is appropriate. Antipathy is not always born from trauma, and can develop, one point at a time as characters slid down a slope of bad choices. Characters who lose their minds to their own vices or obsessions are an example.

Overcoming Antipathy

With time, the desire, and the willingness to overcome their own issues, characters can reduce or even remove their antipathy entirely. Furthermore, sufficiently advanced Science can reduce antipathy and remove issues.



Player Characters who spend a sufficient amount of time attempting to come to terms with whatever has caused them to gain Antipathy (such as in therapy or deep meditation) may, at the GM's discretion, roll a Wisdom saving throw, DC 10 + Antipathy Score to overcome one point of Antipathy. Characters may attempt this once per long rest so long as the time has been spent confronting their insanity and mental imbalance, either with a successful therapist or with meditation.

Pharmaceuticals can help keep the symptoms in check and generally give you Advantage on any attempt to resist an onset or episode if the dosage and diagnosis are correct, however, unless the character is also in psychotherapy and working to overcome their issues then the effectiveness of drugs will eventually wane.

Losing to Antipathy

Characters can succumb to their own mental demons. When a character has gained an Antipathy Score higher than their Wisdom Score, they are lost to their own issues and no longer capable of functioning as adventurers and heroes. Likely they will become self-absorbed and while they may mean well, they are lost unless their mind can be healed. If a player character gains more antipathy than their Wisdom Score, they are retired, unless the GM allows the player to continue to play their character's decline in to irrational madness.

Issues and Antipathy

Issues are specific insanities: like phobias, obsessions, or schizoaffective disorders. Most issue has three degrees, Minor, Major, and Acute. When creating specific Issues for characters, you will dictate the source, the focus, and the trigger. The degree of the issues will determine the mechanical effects, if any.

Obsessive Compulsions

An Obsession is a fixation on a specific person, place, subject, or idea. A compulsion is the need to act upon an obsessive fixation.

Obsessive Attraction occurs when the character is obsessed with a person, place, or thing - the character must possess it, will harass and become violent if anything threatens their bond, and will be intensely jealous. This is particularly dangerous if the target of the obsession is a person - they will stalk the victim, harass, and threaten anyone to whom the victim shows kindness. Obsession with an object can lead to violence if it is not in the person's possession.

Obsessive Ritualism is the kind of Obsessive compulsive disorder most commonly associated with "clean freaks" and hoarders. Characters unable to complete their ritual will suffer extreme anxiety and may become psychotic if they are not allowed to perform their ritual. This ritual must be completed daily, and character will seek to perform their ritual when under stress, frightened, or unoccupied.

Minor: Character will be guarded and protective of their fixation; if it is threatened or ritual impeded in any way, they must succeed a Wisdom saving throw with a DC of 8 + Antipathy score or become Provoked, targeting whoever threatened their fixation. When separated from their fixation or unable to perform their ritual they must succeed a Wisdom saving throw against DC 8 + Antipathy score or suffer from Anxiety until reunited or completed.

Major: Characters with a Major obsession cannot resist the Anxiety that comes from separation of their fixation or inability to perform their ritual, and have Disadvantage on saving throw to resist the provocation if their fixation is threatened.

Acute: At this point their obsession is debilitating - If the character is denied their fixation or ritual, they must succeed a Wisdom saving throw DC of 8 + Antipathy score or go in to Shock! If successful they suffer Anxiety from separation and must perform their ritual consistently. Even worse, they are considered provoked by even the slightest perceived threat to their fixation.

Psychosis

Sometimes considered the classic mental illness, a psychosis is a sever break in the character's perception of reality versus the actual reality. While the character will be constantly aware of and hold their delusional psychosis to be true, they generally only suffer when they trigger an episode.

Psychotic Delusions include maladies such as paranoia, megalomania, disassociation, and classical schizophrenia. The delusion is a belief or idea that is so ingrained the character holds it absolutely true. **Hallucinations** are like delusions in that the character is tormented by something that is not real, but in the case of hallucinations they will hear, see, or feel their tormentors. Sometimes it's as simple as hearing voices, or it can be full blown illusionary people.

Minor: Minor psychosis manifests as brief episodes of detachment from reality brought about by intense stress or a specific trigger. The Character must succeed an Intelligence saving throw DC of 8 + Antipathy score or become Dazzled or suffer from Anxiety until they have a short rest.

Major: With Major psychosis, the Dazzled effect is constant, they are continuously preoccupied with their malady. However, in times of stress, such as combat or action the character can attempt an Intelligence saving throw DC of 8 + Antipathy score to become lucid, overcoming the Dazzled condition until the end of the encounter.

Acute: Characters who suffer from acute psychosis are lost in their minds, perceiving things so detached from reality that they must attempt Intelligence saving throw DC of 8 + Antipathy score to take any action that is based on outside stimuli, and do so with the penalties of Dazzled or Anxiety, unless they are Provoked.

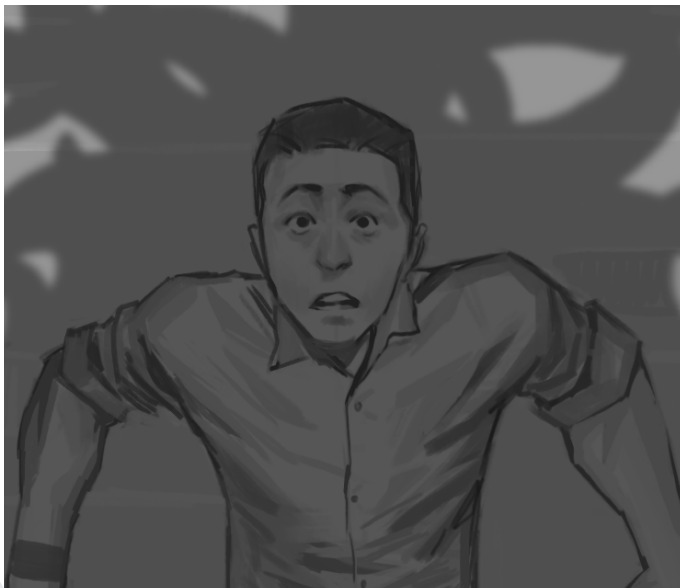

Phobia

An irrational overwhelming fear of an object, event, or idea is a Phobia. True phobias are extremely overpowering and will cripple a person who is confronted with the object of their phobia. Phobic characters can also have episodes triggered by the simple idea of their phobia.

Minor: The character can function normally, but if presented with their phobic fixation must succeed a Wisdom saving throw DC of 8 + Antipathy score or become Frightened. Furthermore, if someone insists that the Phobic fixation is near or present, the character must succeed an Intelligence saving throw DC of 8 + Antipathy score or be afflicted with Anxiety until they can perform a short rest.

Major: Major phobias are almost delusional in their persistence. If the character is presented with their fixation, they must succeed a Wisdom saving throw DC of 8 + Antipathy score or become frightened and can only attempt to flee; if they succeed, they still suffer the effects of anxiety. Bringing up the Phobia will cause Anxiety.

Acute: At this point a phobia is extremely dangerous, Characters presented with their Phobic fixation must succeed a Wisdom saving throw DC of 8 + Antipathy score or go in to Shock, if they succeed, they are Frightened. Bringing up the fixation causes Anxiety, and the character must succeed a Wisdom saving throw DC of 8 + Antipathy score or become Frightened.

Personality Disorder

While generally considered functional disorders, not all personality disorders have acute or even major conditions. Some are limited to minor conditions.

Bipolar disorder occurs when a character swings between intense highs and intense lows - it is a neurological condition but can be treated with resolve and self-restraint.

Minor: The character is rarely just level, and each day must succeed a Resolve Check VS Antipathy or swing towards an extreme:

In a Manic state the character is energized if dangerously unreliable and oblivious to risks. Advantage on initiative checks, immune to Anxiety and Frightened. However, they cannot gauge risks and will not believe that dangers are real, will take unnecessary chances, and will not recognize failures.

In Melancholy state the character has no energy or interests and is dangerously self-destructive. Character cannot use feats, has disadvantage on initiative, must succeed a Wisdom saving throw DC of 8 + Antipathy score to use defense specialties.

Chronic Anxiety is a debilitating state of constant fear and apprehension; the character is functional, but just barely. Major Anxiety can also induce panic attacks.

Minor: During times of stress, or when the GM chooses the player must succeed a Wisdom saving throw DC of 8 + Antipathy score to see if the character succumbs to their Anxiety for 1d4 minutes.

Major: The player must succeed a Wisdom saving throw DC of 8 + Antipathy score at the beginning of an encounter or the character spends that scene suffering from Anxiety. At any point the GM may call upon a Wisdom saving throw DC of 8 + Antipathy score to see if the character suffers a panic attack, suffering Anxiety and Frightened for 1d4 minutes.

Chronic Depression is a state of untenable melancholy and sadness. Essentially crippling a character's ability to interface with people and situations; untreated chronically depressed characters may take their own lives (Wisdom saving throw DC of 8 + Antipathy score when faced with any severe loss or emotional trauma).

Minor: Character can function regularly but suffers Disadvantage on all Charisma Specialties, and receives no benefits from moral boosting situations.

Major: in addition to the above, the character is consistently at Disadvantage on defensive reaction rolls, receives no bonuses from moral, and must make a Wisdom saving throw DC of 8 +

Antipathy score or give up when faced with any kind of challenge or stress.

Manic Aggression is effectively an addiction to anger, or a preoccupation with aggressive thoughts. Characters who suffer from manic aggression are easily provoked, violent, and volatile.

Minor: The character cannot resist attempts to provoke them, cannot and will not pull punches, and will not respond to please for mercy if provoked.

Major: In addition to the above, the character must roll a Wisdom saving throw DC of 8 + Antipathy score or become provoked by even the slightest annoyance or insult. While provoked the character will be blind with rage and will just as easily hurt loved ones and allies as they would enemies or antagonists.

Mentally Ill Player Characters

Playing a character with Antipathy can add an extra dimension to the depth of the experience. Besides the mechanical implications issues have on the character, playing the effects of issues like obsessions, delusions, and personality disorders can be a fun way to really create a unique, if troubled, character. This added depth often adds to a sense of personality and helps bring about memorable characters.



APPENDIX B: HOSTILES

The Arc is a dangerous place, and not just because of the perils of space. There are hundreds of thousands of worlds that harbor life, and not all that life comes in peace.

Aberration. Mutations and deviations from naturally occurring species due to engineering of infection.

Beasts. Animals that are the product of natural selection and evolution.

Machine. A mechanical construct.

Monstrosity. An inherently hostile and unnatural organism that seeks only death and destruction.

COMBAT DRONES

Small machine, unaligned

Armor Class 14 (natural armor)

Armor Rank 16 (+2)

Hit Points 9 (2d6+2)

Speed Flying 40m.

STR	DEX	CON	INT	WIS	CHA
9 (-1)	14 (+2)	12 (+1)	7 (-2)	10 (+0)	2 (-4)

Senses blindsight 20m, passive Perception 9

Condition Immunities Anxiety, Charmed, Deafened, Exhaustion, Frightened, Poisoned, Provoked, Septicemia, Shock

Languages –

Challenge 1/4 (50 XP)

Extremophile. Drones can operate in a vacuum and are resistant to radiation damage.

Actions

Laser Carbine. +5 to hit, range 100/300m, one target Hit: 8 (4d4) Thermal damage

Standard spec combat drones used for security, ship to ship combat, and military support, these flying laser guns have primitive automation controls and limited ability to follow verbal commands of authorized personal.

DRIFT SPIDER

Tiny beast, unaligned

Armor Class 11 (natural armor)

Hit Points 2 (1d4)

Speed 20m, zero gravity 5m.

STR	DEX	CON	INT	WIS	CHA
3 (-4)	11 (+0)	10 (+0)	1 (-5)	8 (-1)	2 (-4)

Skills Stealth +2

Senses blindsight 10m, passive Perception 9

Languages –

Challenge 0 (15 XP)

Extremophile. The spider can survive in a vacuum and is resistant to radiation damage.

Climb. Drift Spiders can climb on virtually any surface in up to medium gravity, including on ceilings and walls, with out need of a check.

Actions

Claw. Melee Weapon Attack: +1 to hit, reach 2m, one target. Hit: 1 slashing damage.

There are many progressively more preposterous hypotheses as to the origin of drift spiders. However, the truth is that these alien pests are probably proof of some methods of panspermia. Regardless, the creature can be found as spores drifting through interstellar space, eager to latch onto passing ships.

Here they grow and infest the ship, either as teaming hordes of hatchlings or a rare mature specimen.

DRIFT SPIDER SWARM

Medium swarm of Tiny beasts, unaligned

Armor Class 11 (natural armor)

Hit Points 24 (7d8 – 7)

STR	DEX	CON	INT	WIS	CHA
3 (-4)	11 (+0)	10 (+0)	1 (-5)	8 (-1)	2 (-4)

Skills Stealth +2

Senses blindsight 10m, passive Perception 9

Languages –

Challenge 1/4 (50XP)

Extremophile. The spiders can survive in a vacuum and is resistant to radiation damage.

Climb. Drift Spiders can climb on virtually any surface in up to medium gravity, including on ceilings and walls, without need of a check.

Actions

Claw. Melee Weapon Attack: +4 to hit, reach 2m, one target in the swarm's space. Hit: 7 (2d6) slashing damage, or 3 (1d6) slashing damage if the swarm has fewer than half of its hit points.

HIGILIAN LION

Medium Abberation, unaligned

Armor Class 12

Hit Points 13 (3d8)

Speed 13m.

STR	DEX	CON	INT	WIS	CHA
15 (+2)	14 (+2)	15 (+2)	4 (-3)	12 (+1)	8 (-1)

Skills Perception +3, Stealth +6

Senses passive Perception 13, Darkvision 10m

Languages –

Challenge 1 (250 XP)

Keen Smell. The Higilian Lion has advantage on Wisdom (Perception) checks that rely on smell.

Pounce. If the Higilian Lion moves at least 7 meters straight toward a creature and then hits it with a claw attack on the same turn, that target must succeed on a DC 14 Strength saving throw or be knocked prone. If the target is prone, the tiger can make one bite attack against it as a bonus action.

Actions

Bite. Melee Weapon Attack: +6 to hit, reach 2m, one target. Hit: 10 (1d10 + 5) piercing damage. **Stingers.** The Higilian Lion's main of wriggling psuopds secrete a dangerous neurotoxin. A creature that is bitten must make a DC 16 Constitution saving throw or be paralyzed for 1d4 rounds.

Claw. Melee Weapon Attack: +6 to hit, reach 2m, one target. Hit: 12 (2d6 + 5) slashing damage.

The Colonists to Higil were the first humans to discover and sample extraterrestrial life. Higil had a microbiome unlike anything that scientists of the time had expected, as studies and spectrograph of the atmosphere predicted that the planet would be lifeless. It was not, and the microbes proved to have a significant effect on the colonist's animals. The most shocking were the cats brought along by several of the colonial families.

The resultant mutation caused the cats to become increasingly large and hostile, and the parasitic tendrils formed a kind of writhing main of tentacles. After hundreds of generations the creatures reverted to a completely feral animal.

K'DORH HOUND

Medium beast, unaligned

Armor Class 12 (natural armor)

Hit Points 19 (3d10 + 3)

Speed 10m, swim 8m

STR	DEX	CON	INT	WIS	CHA
13 (+1)	15 (+2)	13 (+1)	3 (-4)	12 (+1)	6 (-2)

Skills Stealth +2

Senses passive Perception 10, Darkvision 10m

Languages –

Challenge 1/2 (100 XP)

Pack Tactics. The K'Dorh has advantage on attack rolls against a creature if at least one of the beast's allies is within 2 meters of the creature and the ally isn't incapacitated.

Actions

Bite. Melee Weapon Attack: +3 to hit, reach 2m, one target. Hit: 7 (2d4 + 2) piercing damage. If the target is a creature, it must succeed on a DC 11 Strength saving throw or be knocked prone.

Occasionally called the first conquest of the Xhu Akreen, the K'Dorh are large omnivorous reptiles that the Xhu domesticated in their prehistory. These meaty beasts resemble a cross between a hound and a crocodile.

MOON CAT

Tiny beast, unaligned

Armor Class 12



HOSTILES

Hit Points 2 (1d4)
Speed 13m climb 8m.

STR	DEX	CON	INT	WIS	CHA
3 (-4)	15 (+2)	10 (+0)	3 (-4)	12 (+1)	7 (-2)

Skills Acrobatics +4, Perception +3, Stealth +4
Senses passive Perception 13
Languages –
Challenge 0 (10 XP)
Keen Smell. The cat has advantage on Wisdom (Perception) checks that rely on smell.

Actions

Claws. Melee Weapon Attack: +0 to hit, reach 2m, one target. Hit: 1 slashing damage.

One of the few animals to spread far and wide with colonists was the Moon Cat – a breed of hairless hyper melanistic earth housecat. The Moon cat is unique due to its adaptation to microgravity environments and ship board life.

MYCELIAL REVENANT

Medium monstrosity, unaligned
Armor Class 8
Hit Points 22 (3d8 + 9)
Speed 7m.

STR	DEX	CON	INT	WIS	CHA
13 (+1)	6 (-2)	16 (+3)	2 (-4)	6 (-2)	2 (-4)

Saving Throws Wis +0

Damage Immunities poison
Condition Immunities poisoned
Damage Vulnerabilities Radiation
Senses blindsight 10m, passive Perception 8
Languages –
Challenge 1/4 (50 XP)

Fortitude. If damage reduces the revenant to 0 hit points, it must make a Constitution saving throw with a DC of 5 + the damage taken, unless the damage is radiation or from a critical hit. On a success, the revenant drops to 1 hit point instead.

Infectious. When the mycelial revenant lands a melee attack, the target must make a DC 14 Constitution Saving Throw or contract the fungal contamination. A DC 18 Wisdom (medicine) check is needed to prevent turning into a revenant.

Actions

Slam. Melee Weapon Attack: +3 to hit, reach 2m, one target. Hit: 4 (1d6 + 1) bludgeoning damage.

One of the more horrific diseases in the Arc was discovered by an unlucky colony ship century

ago. Highly infectious spores turned the crew into mindless walking corpses desperate to reach and infect other creatures with the fungus.

NUBYOGOT

Small beast, unaligned
Armor Class 12
Hit Points 3 (1d6)
Speed 5m, fly 10m.

STR	DEX	CON	INT	WIS	CHA
4 (-3)	15 (+2)	9 (-1)	6 (-2)	10 (+0)	4 (-3)

Skills Perception +2, Stealth +4

Senses Darkvision 10m, passive Perception 12
Languages Understand Magoi but cannot speak

Challenge 1/4 (50 XP)

Psionic Resistance. The Nubyogot has advantage on saving throws against psionic abilities and other psionic effects.

Limited Telepathy. Nubyogots can communicate simple ideas, emotions, and images telepathically with any creature within 30 meters of it.

Actions

Tentacles. Melee Weapon Attack: +4 to hit, reach 2m, one target. Hit: 1 bludgeoning damage, and the target is grappled (escape DC 10). Until this grapple ends, the nubyogot can't use its tentacles on another target.

Disruption. Psionic Attack: range 5m, DC 12 Intelligence saving throw or suffer 1d6 psychic damage and be paralyzed until the end the nubyogot's next turn.

The favored companions of the Thothid, nubyogots are psionically active cephalopods that drift around their ships and stations acting as guard dogs and observers. Intelligent enough to sense danger and recognize allies, these strange creatures may have been created, and not naturally occurring.

PHAETALIA

Tiny beast, unaligned
Armor Class 12
Hit Points 1 (1d4 – 1)
Speed 3m, fly 15m.

STR	DEX	CON	INT	WIS	CHA
2 (-4)	14 (+2)	8 (-1)	6 (-2)	12 (+1)	6 (-2)

Skills Perception +3

Senses passive Perception 13

Languages Ephari

Challenge 0 (10 XP)

Luminescent. Phaetelia are brightly bio-luminescent and cast dim light in a 5m radius.

Mimicry. The raven can mimic other voices and sounds, as well as music. A creature that hears the sounds can tell they are imitations with a successful DC 10 Wisdom (Insight) check.

Actions

Bite. Melee Weapon Attack: +4 to hit, reach 2m, one target. Hit: 1 piercing damage.

While the WorldShip of the envoi was a complex ecosystem, the Phaetelia were the wanderer's companions in the void. These inquisitive and intelligent creatures resemble a rainbow-plumed feathered lizard more than a bird. Notably these creatures steadily emit a modest illumination.

SLUDGEWORM

Huge monstrosity, unaligned

Armor Class 18 (natural armor)

Hit Points 195 (17d12 + 85)

Speed 10m, swim 20m.

STR	DEX	CON	INT	WIS	CHA
24 (+7)	11 (+0)	21 (+5)	1 (-5)	8 (-1)	2 (-5)

Saving Throws Con +11, Wis +4

Senses blindsight 10m, tremorsense 20m, passive Perception 9

Languages -

Challenge 11 (7,200 XP)

Amphibious. The Sludge Worm can survive in water and muck as well as dryland.

Damage Immunities. Sludge Worms are immune to Poison and Corrosive damage.

Actions

Multiattack. The worm makes two attacks: one with its bite and one with its crab-like claws.

Bite. Melee Weapon Attack: +7 to hit, reach 3m, one target. Hit: 22 (3d8 + 9) piercing damage.

If the target takes damage, it must succeed on a DC 15 Constitution saving throw or contract septicemia in the bite wound.

Claws. Melee Weapon Attack: +7 to hit, reach

3m, one creature. Hit: 19 (3d6 + 9) piercing damage, and the target must make a DC 15 Constitution saving throw, taking 21 (6d6) poison damage on a failed save, or half as much damage if successful.

One of the most repulsive creatures in the arc, the Sludge Worm is a parasitic creature that lays eggs in the food supply of other creatures, and then gestates quickly inside the creature, only to burst out, consume the host, and then anything else while growing rapidly. They can often be found lurking in the waste reclamation systems of large ships and stations and are a constant problem in colonial sewers.

ULTARTHID

Medium Aberration, Passionate or Zealous Alignment

Armor Class 15 (armored coat)

Armor Rank 17 (+1)

Hit Points 33 (6d8 + 6)

Speed 10m

STR	DEX	CON	INT	WIS	CHA
11 (+0)	14 (+2)	12 (+1)	16 (+3)	13 (+1)	14 (+2)

Skills Intuition +5, Deception +4, Persuasion +4

Senses passive perception 13

Languages Unknown

Challenge 4 (1,100 XP)

Mental Shield. The Ultrathid has Advantage on saving throws against psionic attacks.

Prescience. Ultrathid add their Wisdom modifier to their Armor Class.

Actions

Ceremonial Dagger. Melee Weapon Attack +2 to hit, reach 2m, one creature Hit: 8 (1d4 slashing +1d10 thermal) damage

Disruption. Psionic Attack: range 10m, DC 14 Intelligence saving throw or suffer 9 (2d8) psychic

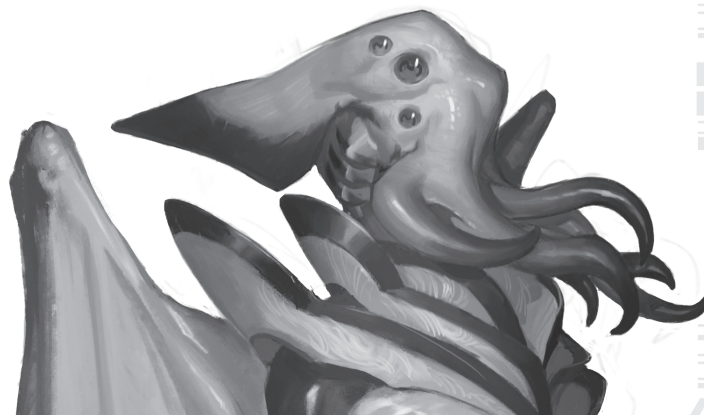

HOSTILES

damage and be paralyzed until the end the ultarthid's next turn.

Rumor has it these violent alien raiders are in fact Thothid rebels that have rejected their culture and embraced a deranged cult of self-mutilation. Whatever the truth, they are violent and dangerous.

VORAX

Large monstrosity, Zealous Alignment

Armor Class 18 (natural armor)

Hit Points 127 (15d10 + 45)

Speed 20m, swim 12m.

STR	DEX	CON	INT	WIS	CHA
18 (+4)	14 (+2)	16 (+3)	12 (+1)	10 (+0)	2 (-4)

Saving Throws Dex +5, Con +6, Wis +3,

Skills Acrobatics +4, Perception +6, Stealth +5

Senses blindsight 30m, passive Perception 16

Languages Unknown

Challenge 7 (2,900 XP)

Extremophile. Vorax can survive in the vacuum of space for up to 72 hours.

Damage Immunities Corrosive, Poison

Actions

Multiattack. The vorax makes three attacks: one with its bite or tongue and two with its claws.

Bite. Melee Weapon Attack: +7 to hit, reach 3m, one target. Hit: 15 (2d10 + 4) piercing damage plus 4 (1d8) corrosive damage.

Tongue Wip. Melee Weapon Attack: +17 to hit, reach 10m, one target. Hit: 12 (2d6 + 4) bludgeoning damage, and the target is grappled (escape DC 14). Until this grapple ends, the target takes 4 (1d8) corrosive damage and the Vorax has advantage on Claw attacks but cannot bite.

Claw. Melee Weapon Attack: +7 to hit, reach 2m, one target. Hit: 11 (2d6 + 4) slashing damage.

Acid Vomit (Recharge 5-6). The Vorax expels a stream of acid 10m long and m wide. Each creature in that line must make a DC 14 Dexterity saving throw, taking 36 (8d8) corrosive damage on a failed save, or half as much damage on a successful one.

One of the most dangerous and hostile alien lifeforms encountered in the Arc is the Vorax Raptora. This ravenous predator is one part parasite, two parts monsters. First encountered in a protogen ruin on a now dead world, and infested ship crashed in the Fane system not long after, releasing these things into the Arc.

Covered in black chiton, with gaunt proportions and exaggerated claws, the Vorax has a long

skeletal tail, and prehensile tongue. Little is understood about how these predators reproduce, but the larval form can infect and gestate in a host creature, feeding off the host as it grows and taking on some of their physical characteristics via osmotic adaption.

WARG (AUTEM WOLVES)

Large beast, Passionate alignment

Armor Class 13 (natural armor)

Hit Points 26 (4d10 + 4)

Speed 20m.

STR	DEX	CON	INT	WIS	CHA
16 (+3)	14 (+2)	13 (+1)	7 (-2)	12 (+1)	8 (-1)

Skills Perception +4, Stealth +4

Senses Darkvision 20m, passive Perception 14

Languages Unknown, some seem to understand Colonial Common

Challenge 1 (250 XP)

Pack Tactics. The wolf has advantage on attack rolls against a creature if at least one of the wolf's allies is within 2m of the creature and the ally isn't incapacitated.

Vicious. If a Wrag has advantage on an attack roll and hits with the attack, the target takes an extra 7 (2d6) damage from the attack.

Actions

Bite. Melee Weapon Attack: +5 to hit, reach 2m, one target. Hit: 10 (2d6 + 3) piercing damage. If the target is a creature, it must succeed on a DC 13 Strength saving throw or be knocked prone.

The rich garden world of Autem offered the colonists of the kind of paradise lost on old earth. But the planet also teemed with indigenous life. The largest and most hostile was the Warg, a beast described as a mix between a hedgehog, wolf, and a gorilla.

Wargs are intelligent, mean, and seem to enjoy hunting humans. Attempts to cull their numbers resulted in a massive backlash as the animals collected small groups and began to attack in night raids on unarmed colonists and children especially. Afterwards, the cull attempts ended, and a status quo was maintained.

The smoldering escape pod wreckage the pilot had ridden to the planet's surface cast the natives in a peculiar light. While they looked human, several had inhuman features; one had pointed ears, another was little over a meter tall, still the strangest was hulking and green with tusks. The green one brandished an eerily glowing blade and spoke.

APPENDIX C: CONVERSION

Inevitably, players will want to use rules or equipment presented here in other OGL5.1 compatible game, such as Dungeons and Dragons. The rules below allow you to convert your spacefaring adventurer to most dungeons and dragons settings or create a character from a fantasy world who has some-how ventured into space.

Generally, characters from Advent Horizon can operate in a fantasy world with no conversion, their advanced skills, weapons, and armor will be on par with powerful spells and magic items, at least until their batteries dry up. On the other hand, characters from fantastic worlds will struggle with the lack of skills necessary to use things like computers and space ships. Their weapons and armor will provide them some protection and their magic can match many energy weapons.

ENTERING DUNGEONS AND DRAGONS

Existing characters from Advent Horizon thrust into a world of magic and monsters can often come to grips quickly with their hostile new environment and primitive team members. Armed



with sophisticated skills and weapons, they might also cause significant disruption by trying to engineer things like steam engines and electricity.

Most will try to find a way home, unless they are given compelling reasons to stay and become a part of this new world. Even then, a spacefaring adventurer may find the crushing weight of gravity too much and feel like life on a single world is too confining.

Ability Scores

The six ability scores are unchanged. Characters from advent horizon can make any and all the ability checks as a fantastic counterpart, with some modifications (see proficiencies, below). While a character's ability scores in advent horizon all provide a bonus, some of these bonuses are rendered meaningless in a fantastic world.

Species

Not all the alien species can enter a fantastic world without worry. While humans might find little trouble being accepted, Ba'alur might be confused for dragonborn, and Emyreans as elves, the same is not true of the other Advent Horizon species. Urroru and Thothid will likely be seen as monster races and treated as a dire threat. Ixaxian might be confused with monstrous insects and attacked, and Xhu will refuse to accept any being as their superior. All of these can cause significant distress and trouble for the characters.

Breeding

In fantastic worlds, the issue of genetics is largely ignored, and it is assumed that all the races are to some degree mutually cross fertile. The same does not hold true for species from the universe of Advent Horizon. The notable exception is colonial humans, who are, for all intent and purposes only slightly removed from the humans of fantasy worlds. These humans can produce beings such as half-elves and half-orcs as any other human parent. No other races can, except through magical means.

Classes

Characters who choose to continue to gain

levels in their chosen advent Horizon class can continue to do so, unchanged. They will continue to gain new ability score bonuses, features and proficiency slots normally.

Feats

If the optional feats rules are in use, once an adventurer from space has gained experience on a fantasy world, they may elect to sacrifice one of the ability score bonuses from class advancement to learn feats just like their fantastic companions. Any prerequisites and requirements remain the same, however.

Multiclass

If they choose to multiclass into a fantastic character class, things do become more complicated. When a character from Advent Horizon enters a fantastic character class, they must meet the same strict prerequisites. However, they receive different proficiencies than their primitive contemporaries, as shown on the table below.

Proficiencies

Adventurers from advanced civilizations will likely have some trouble accepting a supernatural cause for many of the phenomena they see. They might be reticent to use magical items until they are more comfortable with magic and may refuse to learn about things that define their common sense.

Learning Fantastic Skills

Characters from advent Horizon will not have access to Intelligence (arcana) and Intelligence (religion) skill checks when they first arrive. Characters with proficiency in Science may make some Intelligence (arcana) checks against their scientific understanding. Religion is harder, while many fantastic worlds have similar theologies as primitive earth, many are completely alien. Advent Horizon Characters should be able to make History (theology) checks against any approximately familiar religion if they possess these proficiencies, but not otherwise.

After some time and exposure, these scientific heroes might come to accept and learn about magic. After gaining one level in their fantastic world, the heroes should be able to make these checks normally. If they choose to progress in their star-faring class, they may use proficiency slots to acquire proficiency in these skills.

Finally, Wilderness skill replaces Nature checks, in most cases, and Survival remains a constitution check for characters from Advent Horizon.

Primitive Tools

Naturally advanced laboratories, fabrication facilities, and repair kits will not exist in their new world of magic. But knowledge of these tools allows the character to use many of their primitive analogues. Advent characters with Proficiency in Medicine and Laboratory can emulate herbalist kit proficiency, Sciences in general can make use of the Alchemist kit, and even make advanced use of chemistry with those tools. Blacksmith's tools and many others can be emulated with Fabrication and Engineering proficiencies at the DM's discretion.

Arms and Armor

As stated above, if the power holds out, sci-fi equipment will provide a significant edge over many monsters and threats in a fantastic world – but not all.

Futuristic weapons from Advent Horizon are exceptionally powerful and lethal. In a primitive world these weapons will be potentially overpowering, and a match for high level magical items and spells. But these weapons do not guarantee the characters superiority in combat. Here are some special considerations.

Firearms

Guns changed the course of human history. In a fantastic world a handgun will make a character as, or more, dangerous than any mage. Firearms generally deal impact damage, and creatures that have resistance to slashing, piercing, and bludgeoning damage should not benefit from resistance to impact damage, unless their resistance is against non-magical attacks. Any creature with resistance to force damage should also gain resistance to impact damage.

Ammunition

A character with proficiency in sciences, engineering and fabrication will have the skills to produce gunpowder and reproduce simple ammunition with a DC 15 check. Each bullet would cost about 1 gold piece in materials to construct.

Energy Weapons

Low level directed energy weapons all deal comparable damage and effect to magics that people in the fantastic world will be able to deal with quite effectively. High power energy weapons are as destructive as the most high-level magic, sometimes more so. Still Resistance to things like heat and fire or lighting maps neatly to the damage types of advanced weapons.

Radiation damage from powerful particle beams has no fantasy analogue and should be exceptionally devastating against magical creatures.

Ammunition

It is practically impossible to recharge spent electrochemical ammunition from plasma and particle beam weapons in a primitive world. No doubt the technophile character will try to jury-rig some manner of magical lightning converter to recharge their laser and ion weapons, however.

Crafting the converter requires a significant number of high-tech components, such as another energy weapon or the power systems of a shuttle. In addition, 500 gold pieces of materials will be needed to fashion the connections and conduits. Finally, a DC 15 Engineering check is needed each time a recharge is attempted.

With the converter completed, lightning magic can be cast into the device, which will recharge one shot to the energy cell for each dice of damage of the lightning attack. If more shots are channeled into the power cell than it can hold, it explodes dealing fire and lightning damage to all creatures in 10 feet equal to the number of shots in the power cell.

Armor

The most significant advantage far-future characters from Advent Horizon will have in a fantasy world is in the form of their armor. Environmental Armors and Power Armors often have their own power supplies and solar backups giving them nearly limitless lifetimes. Advanced armors also provide vastly superior protection.

Armor rank is not used in fantasy games, as most of the attacks are from energy or primitive weapons. Advanced Armors offer significantly more protection than ancient counterparts. For characters in Medium Tactical Armor, Heavy Tactical Armor, and Power Armor add ½ the Armor Rank Modifier to the Armor Class.

Cybernetics

The idea of Cybernetic augmentation might confuse or even frighten characters from a fantastic world. Others, especially those from cultures with long history of using magic to augment their bodies, might simply see nothing special about the process. But in a world of magic significant cybernetic augmentation inhibits a character's ability to connect to and leverage magical items.

Each 2 cyber tolerance of cybernetic augmentation a character has, they lose one magical item attunement slot, as it becomes harder for them to forge a spiritual connection to the item.

ENTERING ADVENT HORIZON

What of fantastic heroes flung through time and space to a distant world or more distant future? Fantasy is full of tales of magical heroes who have crossed the boundaries of time or reality only to find worlds unlike anything they can imagine. It's not hard to conceive that same could befall heroes from Dungeons and Dragons worlds.

Eventually players will want to use material printed in Dungeons and Dragons, be it classes or races or both. There are several ways for the GM to incorporate these rules without being forced to include magic into their game.

Primitive World Characters

More than a few planets have reverted from technologically advanced to medieval. New characters could hail from a corner of one of these worlds only to be foisted into the void through no choice of their own. Such characters could begin with a nonmagical fantasy class such as a fighter or rogue. These characters could only gain specialties if they multiclass into Advent Horizon character classes.

Ability Scores

The six ability scores are unchanged. Characters from fantasy worlds can make any and all the ability checks, with some modifications (see proficiencies, below). New characters who hail from a primitive world will receive a bonus to their initial reputation and Credit based on their ability scores as any other Advent Horizon character.

Races

Many of the races from worlds of magic can be used in Advent Horizon, with little conversion. Those that possess magical abilities, in the form of cantrips or a number of spells per day might receive psionic skills in their place. With the game master's permission, racial feats can be taken as Trait specialties.

Races that have traveled to the distant stars from worlds of magic find that they are unchanged.

Classes

Whether adventurers from distant worlds of swords and sorcery find their class abilities changed, depends on the GM. If magic continues to function, there is no need to convert or alter any class abilities.

If not spell slots, and magical class abilities with a number of uses per such as channel divinity, wildshape, ki points, lay on hands, cleansing touch, sorcery points, and arcane recovery do not recover following a short or long rest.

At-will magical abilities such as cantrips, divine senses, invocations, summoning an attuned weapon, and so forth will function 1d4 more times before their magical energy is exhausted.

Characters must find some source of magical energy to recover and recharge their supernatural abilities. Ancient places of power or unusual protogen artifacts might have enough magical essence to replenish the character following a long rest absorbing the font of energy, but such sites are extremely rare, even in the Arc.

If they choose, the adventurers may continue to progress in their fantastic class but will not gain access to specialties or advance proficiencies such as sciences or engineering. With GM permission, Computers and Piloting could be trained like languages and tool proficiencies during downtime.

Those who continue to adventure in this realm may make use of the weapons and armors available to them and even receive augmentation, with the risk of losing magical item attunement.

Proficiencies

Ability checks and tool proficiencies are largely unchanged. Survival is a Wisdom check for fantastic characters, and Arcana and Religion are largely meaningless.

Advent Horizon checks such as Science, Engineering, and Computers are unavailable to fantastic characters. Character's proficient in Alchemists Tools have a slightly better chance to grasp scientific methodology, and may attempt Science checks with disadvantage, and cannot gain advantage on these checks.

If a character achieves a level in a fantasy class that offers bonus proficiencies from a class feature, the character may not select Advent Horizon proficiencies unless they also undergo Training (Section 9, Downtime Activities).

Some modern weapons are relatively simple to grasp. Simple Guns can be learned by any character with simple weapon proficiency

following 1d6 days of practice.

Advanced modern weapon skills are specialties, and unavailable unless the character takes an Advent Horizon class.

Multiclassing

After adventuring in space, fantasy character who meet the prerequisites can select Advent Horizon classes when they achieve a new level of experience.

When a fantasy character enters an Advent Horizon class for the first time, in addition to the bonus proficiencies they receive, they gain a number of specialty slots equal to their Intelligence modifier +1 (minimum of 1).

As they progress in an Advent Horizon class, they will gain additional proficiency slots every three levels of these classes. Fantastic class levels do not count towards gaining new proficiencies.

Credit and Reputation

The moment a character arrives in Advent Horizon from a fantastic world, they fact that the don't exist in the systems of the Arc will cause all manner of troubles. These characters have no identity cards, records, credit history, known associates, or social networks. This means they have 0 Credit and 0 reputation.

To earn these fantastic characters must do missions and sell loot to gain Credit and reputation.

Credit

Upon arriving in this strange new world, characters laden with gold and loot have no way to purchase goods or services on any industrialized world and may not make Credit checks. Fantasy characters can exchange gold and items for Credit, however. Every 500 gold pieces worth of non-magical equipment will net the character a Credit modifier of +1, and the option to roll Credit checks.

Reputation

It is not unheard of for a primitive to arrive at a space port wide eyed and bewildered. Most civilized planets have protocols in place for registering unknown cultures and adding identity information into the Astral network. Up to this point, however, they are unknown, and cannot meaningfully leverage their reputation in any way.

Once fantastic characters have been registered by any kind of authority, they become part of the system, and suddenly people who

make a business of knowing, will become aware of the character's existence and actions. At this point, each time the character gains a level, and when they perform missions and earn respect, they will earn reputation, just like any other character in the universe of advent Horizon.

Arms and Armor

The weapons and armor fantasy adventurers are equipped with when they arrive in advent horizon will not necessarily laughably outmatched. After all, a sword is still lethal, and a steel breast plat can easily stop a .22.

Arms

In space, the danger of firearm recoil and missing your target lead to a resurgence of melee weapons for ship and station-board combat. This puts fantasy characters on even footing with many opponents in a number of environments.

Adamantine and Magical weapons will ignore an amount of armor rank equal to their bonus, +1 in the case of adamantine.

Armor

When it comes to modern weapons ancient armor will be somewhat ill prepared. Standard ancient armors provide a normal armor class, and maximum dexterity bonus, but will not provide an armor rank. Magic Armor provides an Armor rank modifier equal to the magical bonus of the item.

Equipment

One of the greatest challenges that adventurers will face is in their day to day tools. With no environmental equipment, they may die quickly in space. They cannot create light with fire aboard a space station or derelict ship. On civilized planets they won't be able to work or hunt to make a living for themselves.

Magic

Spells and magical items are comparable to many advanced pieces of technology, and so little conversion is necessary. Obviously, things like fire and lightning carry additional risks and limitations in space, and may be a problem for some characters, but generally, little conversion is necessary for magic.

Receiving augmentation will limit a character's ability to attune magical items, but not their spell ability, unless the GM chooses otherwise.

Spells and magic that have specific energy interactions, should have these same interactions with Advent Horizon energies and materials.

Teleportation is extremely powerful in a world limited by relativity. Attempting to teleport or open a portal while in Horizon Space is suicidal, as attempting to move through this subspace will cause a 15-meter diameter antimatter explosion dealing 5d10 radiation damage per level of the spell cast centered on the target point of the spell. Cantrips that allow teleportation deal 3d10 damage from the interaction. Taking a bag of holding or devouring or portable hole in to Horizon Space will cause the item's magic to fail.

Magic which deals radiant and necrotic damage will find that, like radiation in a fantastic world, are extremely potent as there is no means of defense or resistance.

Finally, magic which provides insight into alignment or protection against an alignment will find their information confused by the moral ambiguity of the Arc, protection and detection of evil will generally fail, unless the GM rules that the targets have intent, they themselves consider evil.



LEGAL INFORMATION

The title of this product “Advent Horizon” is Product Identity as defined in Section 1(e) of the Open Gaming License, Version 1.0a as are all proper names, excluding those of actual stars and planets, people, and principles or theories. The following terms and subjects are not Open Content: Advent Horizon, Protogen, Protogen Races, and The Arc. Any and all fiction text describing the setting, including the cultures, worlds, or history, is protected content and cannot be reproduced.

This material is being released using the Open Gaming License Version 1.0a and you should read and understand the terms of that license before using this material. All the rules, species traits, class statistics and features, proficiencies, specialties, equipment, and augmentation described in this product is Open Content. Use of these rules is allowed under as described in Section 1(d) of the Open Gaming License.

Permission to copy, modify and distribute the files collectively known as the System Reference Document 5.1 (“SRD5”) is granted solely through the use of the Open Gaming License, Version 1.0a.

The text of the Open Gaming License itself is not Open Game Content. Instructions on using the License are provided within the License itself.

The following items are designated Product Identity, as defined in Section 1(e) of the Open Game License Version 1.0a, and are subject to the conditions set forth in Section 7 of the OGL, and are not Open Content: Dungeons & Dragons, D&D, Player’s Handbook, Dungeon Master, Monster Manual, d20 System, Wizards of the Coast, d20 (when used as a trademark), Forgotten Realms, Faerûn, proper names (including those used in the names of spells or items), places, Underdark, Red Wizard of Thay, the City of Union, Heroic Domains of Ysgard, Ever-Changing Chaos of Limbo, Windswept Depths of Pandemonium, Infinite Layers of the Abyss, Tarterian Depths of Carceri, Gray Waste of Hades, Bleak Eternity of Gehenna, Nine Hells of Baator, Infernal Battlefield of Acheron, Clockwork Nirvana of Mechanus, Peaceable Kingdoms of Arcadia, Seven Mounting Heavens of Celestia, Twin Paradises of Bytopia, Blessed Fields of Elysium, Wilderness of the Beastlands, Olympian Glades of Arborea, Concordant Domain of the Outlands, Sigil, Lady of Pain, Book of Exalted Deeds, Book of Vile Darkness, beholder, gauth, carrion crawler, tanar’ri, baatezu, displacer beast,

githyanki, githzerai, mind flayer, illithid, umber hulk, yuan-ti.

All of the rest of the SRD5 is Open Game Content as described in Section 1(d) of the License.

The terms of the Open Gaming License Version 1.0a are as follows:

OPEN GAME LICENSE Version 1.0a

The following text is the property of Wizards of the Coast, Inc. and is Copyright 2000 Wizards of the Coast, Inc (“Wizards”). All Rights Reserved.

1. Definitions: (a)“Contributors” means the copyright and/or trademark owners who have contributed Open Game Content; (b)“Derivative Material” means copyrighted material including derivative works and translations (including into other computer languages), potation, modification, correction, addition, extension, upgrade, improvement, compilation, abridgment or other form in which an existing work may be recast, transformed or adapted; (c) “Distribute” means to reproduce, license, rent, lease, sell, broadcast, publicly display, transmit or otherwise distribute; (d)“Open Game Content” means the game mechanic and includes the methods, procedures, processes and routines to the extent such content does not embody the Product Identity and is an enhancement over the prior art and any additional content clearly identified as Open Game Content by the Contributor, and means any work covered by this License, including translations and derivative works under copyright law, but specifically excludes Product Identity. (e) “Product Identity” means product and product line names, logos and identifying marks including trade dress; artifacts; creatures characters; stories, storylines, plots, thematic elements, dialogue, incidents, language, artwork, symbols, designs, depictions, likenesses, formats, poses, concepts, themes and graphic, photographic and other visual or audio representations; names and descriptions of characters, spells, enchantments, personalities, teams, personas, likenesses and special abilities; places, locations, environments, creatures, equipment, magical or supernatural abilities or effects, logos, symbols, or graphic designs; and any other trademark or registered trademark clearly identified as Product identity by the owner of the Product Identity, and which specifically excludes the Open Game Content; (f) “Trademark” means the logos, names, mark, sign, motto,

designs that are used by a Contributor to identify itself or its products or the associated products contributed to the Open Game License by the Contributor (g) "Use", "Used" or "Using" means to use, Distribute, copy, edit, format, modify, translate and otherwise create Derivative Material of Open Game Content. (h) "You" or "Your" means the licensee in terms of this agreement.

2. The License: This License applies to any Open Game Content that contains a notice indicating that the Open Game Content may only be Used under and in terms of this License. You must affix such a notice to any Open Game Content that you Use. No terms may be added to or subtracted from this License except as described by the License itself. No other terms or conditions may be applied to any Open Game Content distributed using this License.

3. Offer and Acceptance: By Using the Open Game Content You indicate Your acceptance of the terms of this License.

4. Grant and Consideration: In consideration for agreeing to use this License, the Contributors grant You a perpetual, worldwide, royalty---free, non--- exclusive license with the exact terms of this License to Use, the Open Game Content.

5. Representation of Authority to Contribute: If You are contributing original material as Open Game Content, You represent that Your Contributions are Your original creation and/or You have sufficient rights to grant the rights conveyed by this License.

6. Notice of License Copyright: You must update the COPYRIGHT NOTICE portion of this License to include the exact text of the COPYRIGHT NOTICE of any Open Game Content You are copying, modifying or distributing, and You must add the title, the copyright date, and the copyright holder's name to the COPYRIGHT NOTICE of any original Open Game Content you Distribute.

7. Use of Product Identity: You agree not to Use any Product Identity, including as an indication as to compatibility, except as expressly licensed in another, independent Agreement with the owner of each element of that Product Identity. You agree not to indicate compatibility or co---adaptability with any Trademark or Registered Trademark in conjunction with a work containing Open Game Content except as expressly licensed in another, independent Agreement with the owner of such Trademark or Registered Trademark. The use of any Product Identity in Open Game Content does not constitute a challenge to the ownership of that Product Identity. The owner of any Product Identity used in Open Game Content shall retain all rights, title and interest in and to that Product Identity.

8. Identification: If you distribute Open Game Content You must clearly indicate which portions of the work that you are distributing are Open Game Content.

9. Updating the License: Wizards or its designated Agents may publish updated versions of this License. You may use any authorized version of this License to copy, modify and distribute any Open Game Content originally distributed under any version of this License.

10. Copy of this License: You MUST include a copy of this License with every copy of the Open Game Content You Distribute.

11. Use of Contributor Credits: You may not market or advertise the Open Game Content using the name of any Contributor unless You have written permission from the Contributor to do so.

12. Inability to Comply: If it is impossible for You to comply with any of the terms of this License with respect to some or all of the Open Game Content due to statute, judicial order, or governmental regulation then You may not Use any Open Game Material so affected.

13. Termination: This License will terminate automatically if You fail to comply with all terms herein and fail to cure such breach within 30 days of becoming aware of the breach. All sublicenses shall survive the termination of this License.

14. Reformation: If any provision of this License is held to be unenforceable, such provision shall be reformed only to the extent necessary to make it enforceable.

15. COPYRIGHT NOTICE

Open Game License v 1.0a Copyright 2000, Wizards of the Coast, LLC.

System Reference Document 5.1 Copyright 2019, Wizards of the Coast, Inc.; Authors Mike Mearls, Jeremy Crawford, Chris Perkins, Rodney Thompson, Peter Lee, James Wyatt, Robert J. Schwalb, Bruce R. Cordell, Chris Sims, and Steve Townshend, based on original material by E. Gary Gygax and Dave Arneson.

END OF LICENSE

Advent Horizon Copyright 2019-2020, Ashram Kain and OgreTree Publishing. All rights reserved.

Authors Ashram Kain, Brandon Miller, James Nixon, and Lee Hadan.

Thank you for Reading!
I'll see you in the Arc!

ADVENT HORIZON



NAME

CLASS

LEVEL

SPECIES

EXPs

AXIS

STRENGTH

CONSTITUTION

DEXTERITY

INTELLIGENCE

WISDOM

CHARISMA

PROFICIENCY BONUS

Strength
Dexterity
Constitution
Intelligence
Wisdom
Charisma
SAVING THROWS

CORE PROFICIENCIES

Prof.	Mod.	Proficiency
		Athletics
		Simple Weapons
		Light Armor
		Hand To Hand
		Acrobatics
		Archery
		Piloting
		Simple Guns
		Sleight of Hand
		Stealth
		Weapons System
		Endurance
		Survival
		Bureaucracy
		Computers
		History
		Investigation
		Engineering
		Science
		Wilderness
		Animal Handling
		Medicine
		Insight
		Intuition
		Perception
		Deception
		Intimidation
		Leadership
		Performance
		Persuasion

INITIATIVE

ARMOR CLASS

ARMOR RANK

HIT POINTS

SPENT

HIT DICE

SUCCESSES

FAILURES

DEATH SAVING THROWS

EDUCATION

PROFESSION

EVENT

MOVEMENT

MOVEMENT

Armor

Weapons

Equipment

Total Credit

Reputation

Languages & Tools

Features

A DEVENT HORIZON



NAME

HAIR

HIGHT

SKIN

MASS

AGE

Specialty Skills & Feats

Total Credit

Reputation



IMAGE

Contacts / Connections

Equipment Stash

TAKE ADVENTURE TO THE STARS

Welcome to the Arc - an expanse of the Milky Way nearly ten thousand light years across. A century after the genetically superior human Emypreans and the alien Xhu clashed over the fate of the colonies, a galaxy of adventure awaits!

Advent Horizon is the definitive Science Fiction role playing game. Completely compatible with the world's greatest role playing game, this book contains all the rules you need to play including 9 new races, 11 new classes, and a host of new skills and abilities.

Advent Horizon allows you to fashion seminal heroes of Science Fiction, complete with all the rules you need to adventure in the depths of space or on alien worlds.

Are you ready to see the galaxy?

OGRETREE PUBLISHING

